







DE LUXE



Radiator valves - perfect aesthetics





DE LUXE TS-98-V

Model		Connection	EAN 90 04174	Order number	Item	€
	HERZ-Design Thermostatic Head MINI, white With hydrosensor, set value range 0–30 °C, with "0" position, frost protection approx. 6 °C adjustable.	M 28 x 1,5	80021 4	S 9200 34	1	
	HERZ-Design Thermostatic Head MINI, chrome-plated With hydrosensor, set value range 0–30 °C, with "0" position, frost protection approx. 6 °C adjustable.		80020 7	S 9200 31	1	
	Herz-TS-Design, with pre-setting and readout, straight model Thermostatic valve, white Radiator connection with cone. Pipe connection with male thread M22x1,5 with cone.	G 1/2"- M22x1,5	80055 9	S 7633 44	1	
	Herz-TS-Design, with pre-setting and readout, straight model Thermostatic valve, chrome-plated. Radiator connection with cone. Pipe connection with male thread M22x1,5 with cone.		80054 2	S 7633 41	1	
	Herz-TS-Design, with pre-setting and readout, angle model Thermostatic valve, white. Radiator connection with cone. Pipe connection with male thread M22x1,5 with cone.	G 1/2"- M22x1,5	80051 1	S 7634 44	1	
	Herz-TS-Design, with pre-setting and readout, angle model Thermostatic valve, chrome-plated. Radiator connection with cone. Pipe connection with male thread M22x1,5 with cone.		80050 4	S 7634 41	1	
	Herz-TS-Design, with pre-setting and readout, reverse angle Thermostatic valve, for installation in the return line, white Radiator connection with cone. Pipe connection with male thread M22x1,5 with cone.	G 1/2"- M22x1,5	80059 7	S 7638 44	1	
	Herz-TS-Design, with pre-setting and readout, reverse angle Thermostatic valve, for installation in the return line, chrome-plated Radiator connection with cone. Pipe connection with male thread M22x1,5 with cone.		80058 0	S 7638 41	1	
	Herz-TS-Design, with pre-setting and readout, 3-Axis Valve - "AB" - Design Thermostatic valve, white Radiator connection with cone. Pipe connection with male thread M22x1,5 with cone.	G 1/2"- M22x1,5	80045 0	S 7645 44	1	
	Herz-TS-Design, with pre-setting and readout, 3-Axis Valve - "AB" - Design Thermostatic valve, chrome-plated. Radiator connection with cone. Pipe connection with male thread M22x1,5 with cone.		80044 3	S 7645 41	1	
	Herz-TS-Design, with pre-setting and readout, 3-Axis Valve - "CD" - Design Thermostatic valve, white. Radiator connection with cone. Pipe connection with male thread M22x1,5 with cone.	G 1/2"- M22x1,5	80046 7	S 7646 44	1	
	Herz-TS-Design, with pre-setting and readout, 3-Axis Valve - "CD" - Design Thermostatic valve, chrome-plated. Radiator connection with cone. Pipe connection with male thread M22x1,5 with cone.		80047 4	S 7646 41	1	

DE LUXE RL-1

Model		Connection	EAN 90 04174	Order number	Item	€
	Herz-Return valve RL-Design, straight model Lockshield, white. Radiator connection with cone. Pipe connection with male thread M22x1,5 with cone.	G 1/2"- M22x1,5	80053 5	S 3733 44	1	
	Herz-Return valve RL-Design, straight model Lockshield, chrome-plated. Radiator connection with cone. Pipe connection with male thread M22x1,5 with cone.	G 1/2"- M22x1,5	80052 8	S 3733 41	1	
	Herz-Return valve RL-Design, angle model Lockshield, white. Radiator connection with cone. Pipe connection with male thread M22x1,5 with cone.	G 1/2"- M22x1,5	80049 8	S 3734 44	1	
	Herz-Return valve RL-Design, angle model Lockshield, chrome-plated. Radiator connection with cone. Pipe connection with male thread M22x1,5 with cone.	G 1/2"- M22x1,5	80048 1	S 3734 41	1	
	Herz-Return valve RL-Design, reverse angle Lockshield, for installation in the return line, white	G 1/2"- M22x1,5	80057 3	S 3738 44	1	
	Herz-Return valve RL-Design, reverse angle Lockshield, for installation in the return line, chrome-plated	G 1/2"- M22x1,5	80056 6	S 3738 41	1	
	Herz-Return valve-RL-3-Axis valve - "AB" - Design Lockshield, white. Radiator connection with cone. Pipe connection with male thread M22x1,5 with cone.	G 1/2"- M22x1,5	80041 2	S 3745 44	1	
	Herz-Return valve-RL-3-Axis valve - "AB" - Design Lockshield, chrome-plated. Radiator connection with cone. Pipe connection with male thread M22x1,5 with cone.	G 1/2"- M22x1,5	80040 5	S 3745 41	1	
	Herz-Return valve-RL-3-Axis valve - "CD" - Design Lockshield, white. Radiator connection with cone. Pipe connection with male thread M22x1,5 with cone.	G 1/2"- M22x1,5	80043 6	S 3746 44	1	
	Herz-Return valve-RL-3-Axis valve - "CD" - Design Lockshield, chrome plated. Radiator connection with cone. Pipe connection with male thread M22x1,5 with cone.	G 1/2"- M22x1,5	80042 9	S 3746 41	1	

Signs and symbols



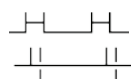



-  Presetable control valve
-  Control valve

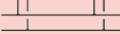

Radiator heating in one-pipe system







Radiator heating in two-pipes system

DE LUXE 3000

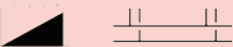
Model		EAN 90 04174	Order number	Item	€
 	H3000-Design, straight model for two-pipe system, white Straight model for two-pipe systems, pipe centre distance 50 mm, radiator connection G 3/4, freely moving nut. Pipe connection with male thread G 3/4 with cone seal for compression adapter. Compression adapters have to be ordered separately.	80035 1	S 3266 04	1	
	H3000-Design, straight model for two-pipe system, chrome-plated Straight model for two-pipe systems, pipe centre distance 50 mm, radiator connection G 3/4, freely moving nut. Pipe connection with male thread G 3/4 with cone seal for compression adapter. Compression adapters have to be ordered separately.	80034 4	S 3266 01	1	
 	H3000-Design, straight model for one-pipe system, white Straight model for one-pipe systems, pipe centre distance 50 mm, radiator connection G 3/4, freely moving nut. Pipe connection with male thread G 3/4 with cone seal for compression adapter. Compression adapters have to be ordered separately.	80033 7	S 3166 04	1	
	H3000-Design, straight model for one-pipe system, chrome-plated Straight model for one-pipe systems, pipe centre distance 50 mm, radiator connection G 3/4, freely moving nut. Pipe connection with male thread G 3/4 with cone seal for compression adapter. Compression adapters have to be ordered separately.	80032 0	S 3166 01	1	
 	H3000-Design, angle model for two-pipe system, white Angle model for two-pipe systems, pipe centre distance 50 mm, radiator connection G 3/4, freely moving nut. Pipe connection with male thread G 3/4 with cone seal for compression adapter. Compression adapters have to be ordered separately.	80007 8	S 3266 14	1	
	H3000-Design, angle model for two-pipe system, chrome-plated Angle model for two-pipe systems, pipe centre distance 50 mm, radiator connection G 3/4, freely moving nut. Pipe connection with male thread G 3/4 with cone seal for compression adapter. Compression adapters have to be ordered separately.	80006 1	S 3266 11	1	
 	H3000-Design, angle model for one-pipe system, white Angle model for one-pipe systems, pipe centre distance 50 mm, radiator connection G 3/4, freely moving nut, chrome-plated. Pipe connection with male thread G 3/4 with cone seal for compression adapter.	80009 2	S 3166 14	1	
	H3000-Design, angle model for one-pipe system, chrome-plated Angle model for one-pipe systems, pipe centre distance 50 mm, radiator connection G 3/4, freely moving nut, chrome-plated. Pipe connection with male thread G 3/4 with cone seal for compression adapter.	80008 5	S 3166 11	1	

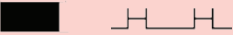

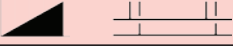

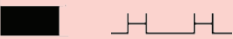

*) Chrome-plated union screw connection

DE LUXE TS-3000

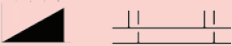
Model		EAN 90 04174	Order number	Item	€
 	H3000-TS-Design, straight model for two-pipe system, white, with pre-setting and readout Straight model for two-pipe systems, pipe centre distance 50 mm, radiator connection G 3/4, freely moving nut, thermostatic head connections M 28 x 1.5; white. Pipe connection with male thread G 3/4 with cone seal for compression adapter. Compression adapters have to be ordered separately.	80037 5	S 3692 44	1	
	H3000-TS-Design, straight model for two-pipe system, chrome-plated, with pre-setting and readout Straight model for two-pipe systems, pipe centre distance 50 mm, radiator connection G 3/4, freely moving nut, thermostatic head connections M 28 x 1.5; white. Pipe connection with male thread G 3/4 with cone seal for compression adapter. Compression adapters have to be ordered separately.	80036 8	S 3692 41	1	
 	H3000-TS-Design, straight model for one-pipe system, white Straight model for one-pipe systems, pipe centre distance 50 mm, radiator connection G 3/4, freely moving nut, thermostatic head connections M 28 x 1.5; white. Pipe connection with male thread G 3/4 with cone seal for compression adapter. Compression adapters have to be ordered separately.	80039 9	S 3792 44	1	
	H3000-TS-Design, straight model for one-pipe system, chrome-plated Straight model for one-pipe systems, pipe centre distance 50 mm, radiator connection G 3/4, freely moving nut, thermostatic head connections M 28 x 1.5; white. Pipe connection with male thread G 3/4 with cone seal for compression adapter. Compression adapters have to be ordered separately.	80038 2	S 3792 41	1	
 	H3000-TS-Design, angle model for two-pipe system, white, with pre-setting and readout Angle model for two-pipe systems, pipe centre distance 50 mm, radiator connection G 3/4, freely moving nut, thermostatic head connections M 28 x 1.5; white. Pipe connection with male thread G 3/4 with cone seal for compression adapter. Compression adapters have to be ordered separately.	80003 0	S 3691 44	1	
	H3000-TS-Design, angle model for two-pipe system, chrome-plated, with pre-setting and readout Angle model for two-pipe systems, pipe centre distance 50 mm, radiator connection G 3/4, freely moving nut, thermostatic head connections M 28 x 1.5; white. Pipe connection with male thread G 3/4 with cone seal for compression adapter. Compression adapters have to be ordered separately.	80002 3	S 3691 41	1	
 	H3000-TS-Design, angle model for one-pipe system, white Angle model for one-pipe systems, pipe centre distance 50 mm, radiator connection G 3/4, freely moving nut, thermostatic head connections M 28 x 1.5; white. Pipe connection with male thread G 3/4 with cone seal for compression adapter. Compression adapters have to be ordered separately.	80005 4	S 3791 44	1	
	H3000-TS-Design, angle model for one-pipe system, chrome-plated Angle model for one-pipe systems, pipe centre distance 50 mm, radiator connection G 3/4, freely moving nut, thermostatic head connections M 28 x 1.5; white. Pipe connection with male thread G 3/4 with cone seal for compression adapter. Compression adapters have to be ordered separately.	80004 7	S 3791 41	1	

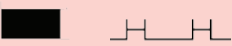

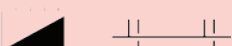
*) Chrome-plated union screw connection

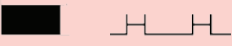
DE LUXE VUA

Model		EAN 90 04174	Order number	Item	€
 	"HERZ-VUA-50-Design, straight model for two-pipe system, white, with pre-setting and readout" Four-port valve, straight model for two-pipe systems, with pre-setting, submerged pipe l = 290 mm, Ø = 11 mm, without bypass, thermostatic head connections M 28 x 1.5; pipe centre distance 50 mm, pipe connections M 22 x 1.5."	80027 6	S 7683 44	1	
	"HERZ-VUA-50-Design, straight model for two-pipe system, chrome-plated, with pre-setting and readout" Four-port valve, straight model for two-pipe systems, with pre-setting, submerged pipe l = 290 mm, Ø = 11 mm, without bypass, thermostatic head connections M 28 x 1.5; pipe centre distance 50 mm, pipe connections M 22 x 1.5.	80026 9	S 7683 41	1	
 	"HERZ-VUA-50-Design, straight model for one-pipe system, white" Four-port valve, straight model for one-pipe systems, with pre-setting, submerged pipe l = 290 mm, Ø = 11 mm, with bypass, thermostatic head connections M 28 x 1.5; pipe centre distance 50 mm, pipe connections M 22 x 1.5."	80031 3	S 7786 44	1	
	"HERZ-VUA-50-Design, straight model for one-pipe system, chrome-plated" Four-port valve, straight model for one-pipe systems, with pre-setting, submerged pipe l = 290 mm, Ø = 11 mm, with bypass, thermostatic head connections M 28 x 1.5; pipe centre distance 50 mm, pipe connections M 22 x 1.5."	80030 6	S 7786 41	1	
 	"HERZ-VUA-50-Design, angle model for two-pipe system, white, with pre-setting and readout" Four-port valve, angle model for two-pipe systems, with pre-setting, submerged pipe l = 290 mm, Ø = 11 mm, without bypass, thermostatic head connections M 28 x 1.5; pipe centre distance 50 mm, pipe connections M 22 x 1.5.	80001 6	S 7684 44	1	
	"HERZ-VUA-50-Design, angle model for two-pipe system, chrome-plated, with pre-setting and readout" Four-port valve, angle model for two-pipe systems, with pre-setting, submerged pipe l = 290 mm, Ø = 11 mm, without bypass, thermostatic head connections M 28 x 1.5; pipe centre distance 50 mm, pipe connections M 22 x 1.5.	80000 9	S 7684 41	1	
 	"HERZ-VUA-50-Design, angle model for one-pipe system, white" Four-port valve, angle model for one-pipe systems, with pre-setting, submerged pipe l = 290 mm, Ø = 11 mm, with bypass, thermostatic head connections M 28 x 1.5; pipe centre distance 50 mm, pipe connections M 22 x 1.5.	80029 0	S 7784 44	1	
	"HERZ-VUA-50-Design, angle model for one-pipe system, chrome-plated" Four-port valve, angle model for one-pipe systems, with pre-setting, submerged pipe l = 290 mm, Ø = 11 mm, with bypass, thermostatic head connections M 28 x 1.5; pipe centre distance 50 mm, pipe connections M 22 x 1.5.	80028 3	S 7784 41	1	

*) Chrome-plated union screw connection

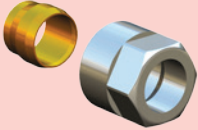
DE LUXE compression adapters

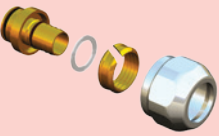
Model		Connection	EAN 90 04174	Order number	Item	€
	Design-Compression adapter M 22 x 1.5 - chrome-plated for steel and copper pipes, metal-to-metal joint towards pipe, locking nut M 22 x 1.5. Not suitable for chromium-plated metal and stainless steel pipes. Nut is chrome-plated, O-Ring sealing.	10	80012 2	S 6284 10	10	
		12	80013 9	S 6284 12	10	
		14	80014 6	S 6284 14	10	
	Design-Compression adapter M 22 x 1.5 - chrome-plated for steel and copper pipes, metal-to-metal joint towards pipe, locking nut M 22 x 1.5. Not suitable for chromium-plated metal and stainless steel pipes. Nut is chrome-plated, O-Ring sealing.	15	80015 3	S 6284 15	10	
		16	80016 0	S 6284 16	10	
		Design-Compression adapter M 22 x 1.5 - chrome-plated rubber joint towards pipe, locking nut M 22 x 1.5. Not suitable for chromium-plated metal and stainless steel pipes. Nut is chrome-plated.	12	80010 8	S 6286 12	10
15			80011 5	S 6286 15	10	
	Design-Compression adapter M 22 x 1.5 - chrome-plated for PE-X, PB and Aluminium composite pipes, locking nut M 22 x 1.5. Nut is chrome-plated.	14 x 2	80017 7	S 6066 14	10	
		16 x 2	80018 4	S 6066 16	10	





HERZ DE LUXE TS-3000 with compression adapter

DE LUXE Accessories

Model		Connection	EAN 90 04174	Order number	Item	€
	HERZ-Design-Handwheel, white for HERZ-Thermostatic valves which are not equipped with a HERZ-Thermostatic head, white.	M 28 x 1,5	80023 8	S 9102 44	1	
	HERZ-Design-Handwheel, chrome-plated for HERZ-Thermostatic valves which are not equipped with a HERZ-Thermostatic head, chrome-plated.	M 28 x 1,5	80022 1	S 9102 41	1	
	HERZ-T-Piece-Design, white for installing radiators to the floor with heating connection	G 1/2"	80061 0	S 1001 44	1	
	HERZ-T-Piece-Design, chrome-plated for installing radiators to the floor with heating connection	G 1/2"	80060 3	S 1001 41	1	
	HERZ-Design integrated isolating valve, white. Left-sided version	G 1/2"	80063 4	S 3720 44	1	
	HERZ-Design integrated isolating valve, chrome-plated. Left-sided version	G 1/2"	80062 7	S 3720 41	1	
	HERZ-Design integrated isolating valve, white. Right-sided version	G 1/2"	-	S 3720 24	1	
	HERZ-Design integrated isolating valve, chrome-plated. Right-sided version	G 1/2"	-	S 3720 21	1	
	Pipe Cover Set, Chrome-plated	ø55- ø18-L70	80064 1	S 6822 00	1	
	Pipe Cover Plate, Chrome-plated	ø55- ø18-L70	80065 8	S 6822 01	1	
	Adapter M 22 x 1.5 - Rp 1/2 - Design, for threaded steel pipes, chrome-plated.	M22x1.5- Rp1/2"	80066 5	S 6220 22	10	

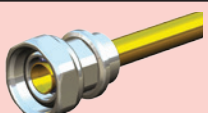
DE LUXE spare parts

Ausführung		Connection	EAN 90 04174	Order number	Item	€
	Design-Connection Tubes, chrome-plated freely moving nut, O-Ring sealing on both sides.	G 1/2 - G 3/4	80025 2	S 6252 11	10	
	Design-Connection Tubes with submerged pipe, chrome-plated O-Ring sealing on both sides, submerged pipe L = 290 mm.	G 1/2 - G 3/4	80024 5	S 6226 51	10	
	Control and Isolating upper part	M 20 x 1,5	80019 1	S 6301 01	1	

DE LUXE valves: order examples

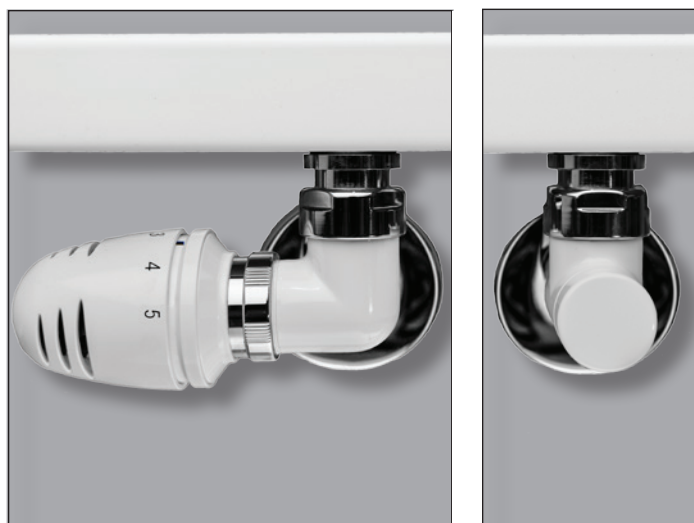

HERZ-Design Thermostatic Head MINI-GS, chrome-plated S **9200** 34*
 Herz-TS-3-Axis Valve - "CD" - Design, chrome-plated S **7646** 44*
 Herz-Return valve RL-Design, angle model, chrome-plated S **3745** 44*
 Compression adapter 15 mm (2 Pcs.) S **6286** 15
 Pipe Cover Set, Chrome-plated S **6822** 00

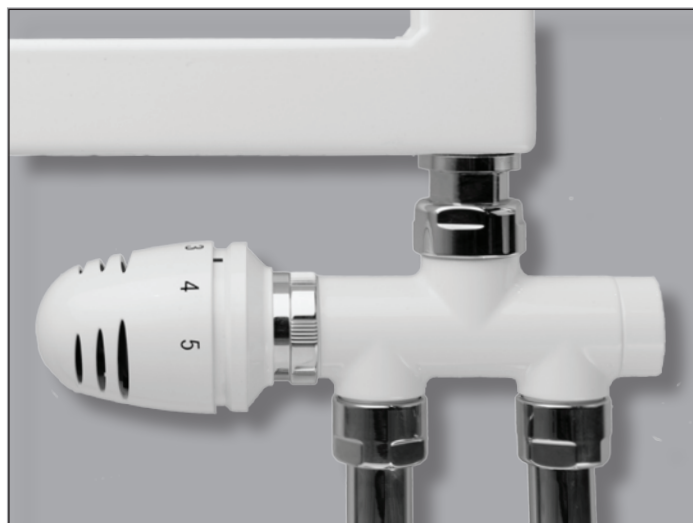

HERZ-Design Thermostatic Head MINI-GS, chrome-plated S **9200** 34*
 HERZ-VUA-50-Design, angle model for one-pipe system S **7783** 44*
 Compression adapter 16*2 mm (2 Pcs.) S **6284** 14
 Pipe Cover Plate S **6822** 01



HERZ-Design Thermostatic Head MINI-GS, chrome-plated S **9200** 31*
 H3000-TS-Design, straight model for one-pipe system S **3792** 41*
 Compression adapter 14 mm (2 Pcs.) S **6284** 14
 Pipe Cover Plate S **6822** 01

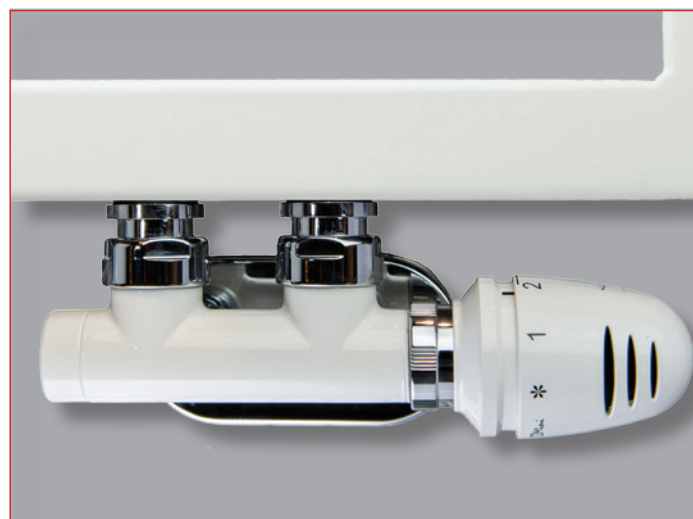

HERZ-Design Thermostatic Head MINI-GS, chrome-plated S **9200** 34*
 H3000-TS-Design, angle model for two-pipe system S **3691** 44*
 Compression adapter 16*2 mm (2 Pcs.) S **6066** 16
 Pipe Cover Plate S **6822** 01

*) The digit "4" at the end of the order number is for the white version, the "1" is for the chrome

Recommended Armatures according to heater types

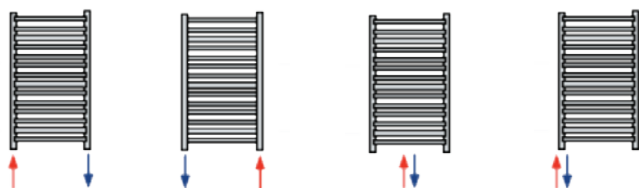

7633	7633	3691	7683
7634	7634	3791	7786
7645	7646	3692	7684
3733	3733	3792	7784
3734	3734		
3746	3745		

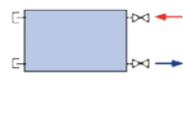

7633
 7634
 7646
 3734
 3746

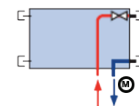

9200
 3691
 3791
 3692
 3792



7633
 7634
 7645
 3734
 3746

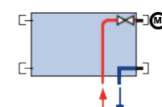

3166
 3266

Technical specification

HERZ Radiator thermostat DE LUXE

With liquid sensor (hydro sensor) for HERZ thermostatic valves DE LUXE. Position "0", adjustable anti-freeze protection, chrome-plated mounting nut.

Thermostatic head with extra-tempered, smooth surface.

Setpoint range 6 – 30 °C
Anti-freeze protection at 6 °C

Radiator thermostats DE LUXE

item no.: S **9200** 34, white
item no.: S **9200** 31, chrome-plated

HERZ TS-98-V Thermostatic valve lower parts DE LUXE

With stepless presetting for direct reading, made of brass, coated in brilliant white, alternatively mirror-finished and chrome-plated, with orange screw cap. Spindle sealing by means of special sealing ring on thermostatic upper part.

Thermostatic valve upper part exchangeable using HERZ CHANGEFIX, torus sealing system with closing force limiter. M22x1.5 with clamping set for calibrated soft steel, copper and plastic pipes.

Radiator connection, self-sealing, chrome-plated. Thermostat operation using HERZ radiator thermostat DE LUXE.

Max. operating temperature 120 °C
Max. operating pressure 10 bar

When using HERZ clamping sets please note the relevant set's operating data.

Straightway valve, R 1/2"

item no.: S **7633** 44, white
item no.: S **7633** 41, chrome-plated

Angle valve, R 1/2"

item no.: S **7634** 44, white
item no.: S **7634** 41, chrome-plated

Special angle valve, R 1/2"

item no.: S **7638** 44, white
item no.: S **7638** 41, chrome-plated

Three-axis angle valve AB, R 1/2"

item no.: S **7645** 44, white
item no.: S **7645** 41, chrome-plated

Three-axis angle valve CD, R 1/2"

item no.: S **7646** 44, white
item no.: S **7646** 41, chrome-plated

HERZ Return valves RL-1 DE LUXE

Made of brass, coated in brilliant white, alternatively mirror-finished and chrome-plated, presetting through stroke limitation. M22x1.5 with clamping set for calibrated soft steel, copper and plastic pipes; self-sealing, chrome-plated radiator connection

Max. operating temperature 120 °C
Max. operating pressure 10 bar

When using HERZ clamping sets please note the relevant set's operating data.

Straightway valve, R 1/2"

item no.: S **3733** 44, white
item no.: S **3733** 41, chrome-plated

Angle valve, R 1/2"

item no.: S **3734** 44, white
item no.: S **3734** 41, chrome-plated

Three-axis angle valve AB, R 1/2"

item no.: S **3745** 44, white
item no.: S **3745** 41, chrome-plated

Three-axis angle valve CD, R 1/2"

item no.: S **3746** 44, white
item no.: S **3746** 41, chrome-plated

HERZ Clamping set DE LUXE

For copper pipes and thin-walled steel pipes. Chrome-plated brass nut, special brass clamping ring. Please refer to the HERZ product range for application areas.

When using HERZ clamping sets please note the relevant set's operating data.

Clamping set with O-ring seal, M22x1.5 gland nut

Dimension: 10 mm, item no.: S **6284** 10
Dimension: 12 mm, item no.: S **6284** 12
Dimension: 14 mm, item no.: S **6284** 14

self-sealing, easy to install radiator connection

100 % chrome-plated surface

metal- and O-ring sealing

O-ring seals on both sides, highly temperature-resistant

Back seal relieves O-ring and enhances operating life.

Easy to install with a hex tip screwdriver, upper part soft sealing

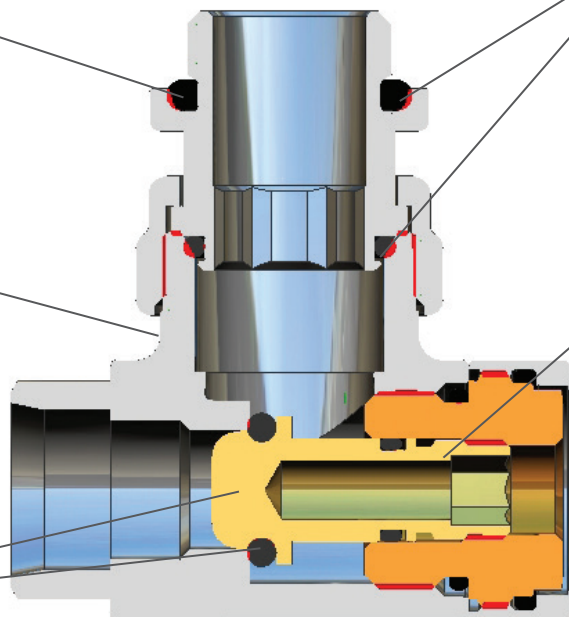

Fig.: RL-1

HERZ compression adapter set DE LUXE

For copper pipes and thin-walled steel pipes. Chrome-plated brass nut, special brass clamping ring. Please refer to the HERZ product range for application areas.

When using HERZ clamping sets please note the relevant set's operating data.

Compression adapter set with metal sealing, M22x1.5 gland nut

Dimension: 10 mm, item no.: S **6284** 15

Dimension: 12 mm, item no.: S **6284** 16

HERZ Compression adapter set DE LUXE

For copper pipes and thin-walled steel pipes. Chrome-plated brass nut, special brass clamping ring.

Please refer to the HERZ product range for application areas.

When using HERZ clamping sets please note the relevant set's operating data.

Compression adapter set with massive rubber seal, M22x1.5 gland nut

Dimension: 12 mm, item no.: S **6286** 12

Dimension: 15 mm, item no.: S **6286** 15

HERZ Compression adapter set DE LUXE

For plastic pipe connection – PE-X, PB and multilayer plastic pipes. Double O-ring and insulating washer. Hose sleeve, hose clamping ring made of brass.

Please refer to the HERZ product range for application areas.

When using HERZ clamping sets please note the relevant set's operating data.

Plastic pipe connection with M22x1.5 chrome-plated gland nut

Dimension: 14 x 2.0 mm, item no.: S **6066** 14

Dimension: 16 x 2.0 mm, item no.: S **6066** 16

HERZ DE LUXE 3000 Connection system for valve radiators

Comprising brass bypass bodies coated in brilliant white, alternatively mirror-finished and chrome-plated.

Radiator can be taken off with pressurized system via HERZ 3000 system parts. Pipe connection with M22x1.5 male thread.

Quick installation system with clamping sets for calibrated soft steel, copper and plastic pipes – pipe connections must be ordered separately. Max. operating temperature 120 °C

Max. operating pressure 10 bar

When using HERZ clamping sets please note the relevant set's operating data.

HERZ 3000 Bypass body

For valve radiators with connection port. Distance between centers: 50 mm as per DIN V3838. With shutoff facility, for single pipe operation with fixed bypass. Angle version for pipes coming from the wall. Straightway version for pipes coming from the floor. R 1/2" radiator connection, self-sealing, chrome-plated.

Bypass body

R 1/2" Radiator connection, M22x1.5 pipe connection
Straightway version
item no.: S **3166** 40, white
item no.: S **3166** 01, chrome-plated

Angle version

item no.: S **3166** 14, white
item no.: S **3166** 11, chrome-plated

HERZ 3000 Bypass body

For valve radiators with connection port. Distance between centers: 50 mm as per DIN V3838.

With shutoff facility, for dual pipe operation, angle version for pipes coming from the wall.

Straightway version for pipes coming from the floor; R 1/2" radiator connection, self-sealing, chrome-plated.

Bypass body

R 1/2" Radiator connection, M22x1.5 pipe connection

Straightway version

item no.: S **3266** 04, white
item no.: S **3166** 01, chrome-plated

Angle version

item no.: S **3266** 14, white
item no.: S **3266** 11, chrome-plated

HERZ DE LUXE – VUA Four-way valves for thermostat operation

Made of brass, coated in brilliant white,



DE LUXE VUA

alternatively mirror-finished and chrome-plated, with screw cap, with single-bore connection to radiator. Radiator connection at bottom, thermostatic operation using HERZ DE LUXE Thermostat MINI, radiator can be taken off with pressurized system. Water flow control to radiator with single pipe operation: 40 %, pipe distance between centers: 50 mm.

Quick installation system with clamping sets for calibrated soft steel, copper and plastic pipes.

Radiator connection R = 1/2", self-sealing with immersion pipe. Spindle sealing with O-ring, O-ring chamber can be replaced without emptying the system.

Upper thermostatic insert replaceable during operation using HERZ Changefix.

M22x1.5 pipe connection.

Pipe connections must be ordered separately.

Max. operating temperature 120 °C

Max. operating pressure 10 bar

When using HERZ clamping sets please note the relevant set's operating data.

Four-way valves

Straightway version for single pipe systems

item no.: S **7786** 44, white

item no.: S **7786** 41, chrome-plated

Angle version for single pipe systems

item no.: S **7784** 44, white

item no.: S **7784** 41, chrome-plated

HERZ DE LUXE TS-3000

Made of brass, coated in brilliant white, alternatively mirror-finished and chrome-plated, with screw cap, with single-bore connection to radiator. Radiator connection at bottom, thermostatic operation using HERZ DE LUXE Thermostat MINI, radiator can be taken off with pressurized system. Water flow control to radiator with single pipe operation: 40 %, pipe distance between centers: 50 mm.

Quick installation system with clamping sets for calibrated soft steel, copper and plastic pipes.

G 3/4" radiator connection with free-spinning nut. Spindle sealing with O-ring, O-ring chamber can be replaced without emptying the system.

Upper thermostatic insert replaceable during operation using HERZ Changefix.

M22x1.5 pipe connection.

Pipe connections must be ordered separately.

Max. operating temperature 120 °C

Max. operating pressure 10 bar

When using HERZ clamping sets please note the relevant set's operating data.



DE LUXE TS-3000

Flow charts

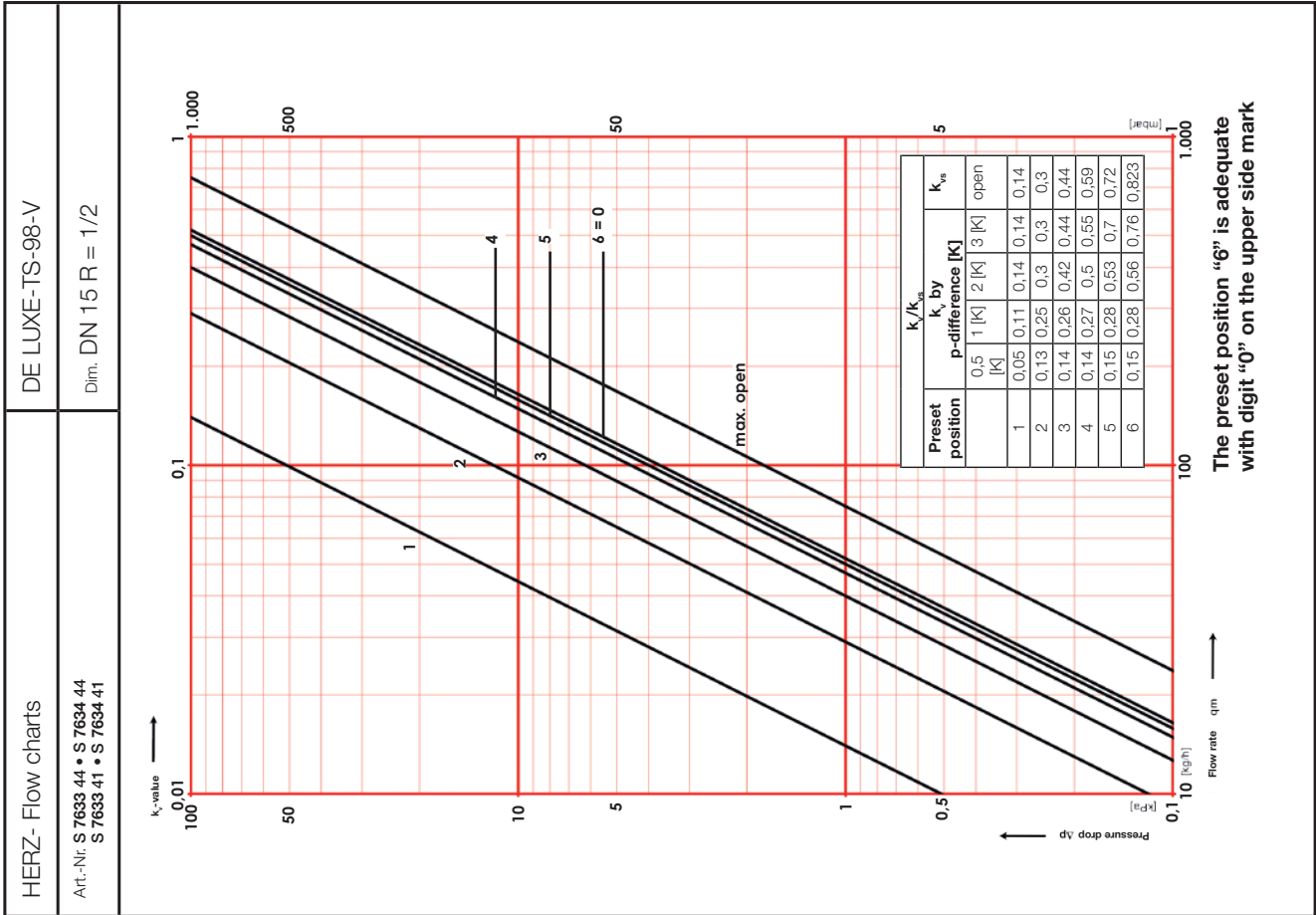

The preset position "6" is adequate with digit "0" on the upper side mark

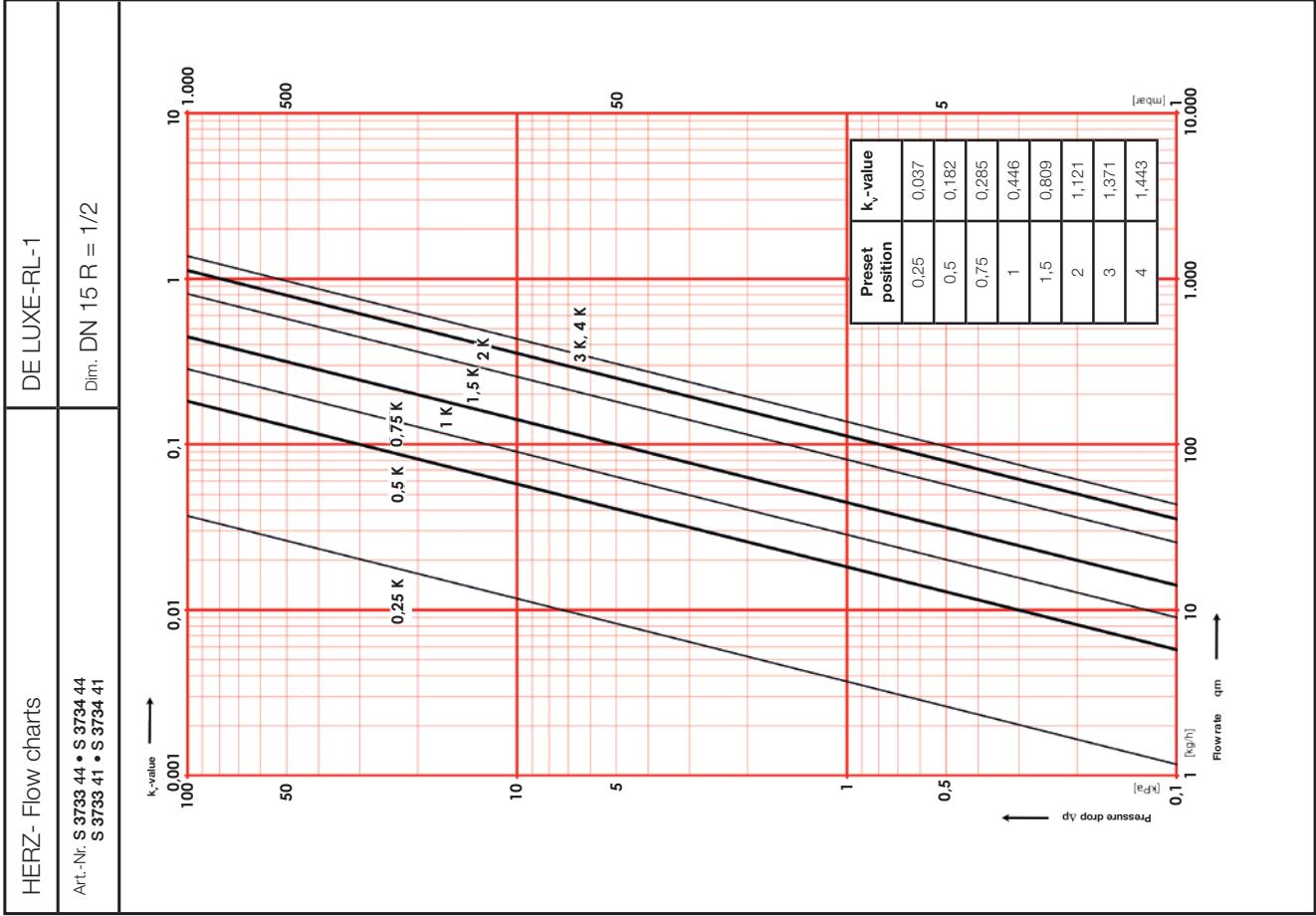

HERZ- Flow charts
 Art.-Nr. S 3266 04 • S 3266 14
 S 3266 01 • S 3266 11

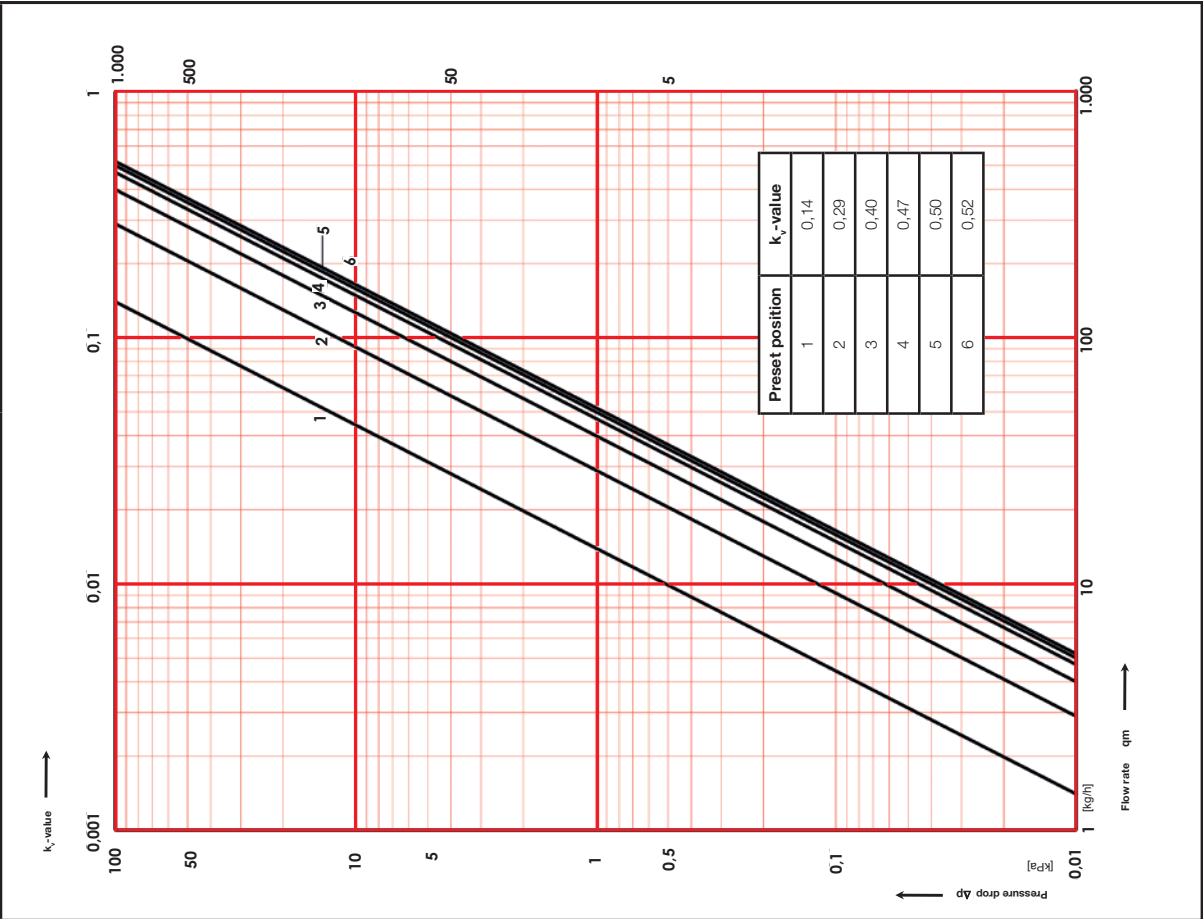

HERZ- Flow charts
 Art.-Nr. S 3166 04 • S 3166 14
 S 3166 01 • S 3166 11

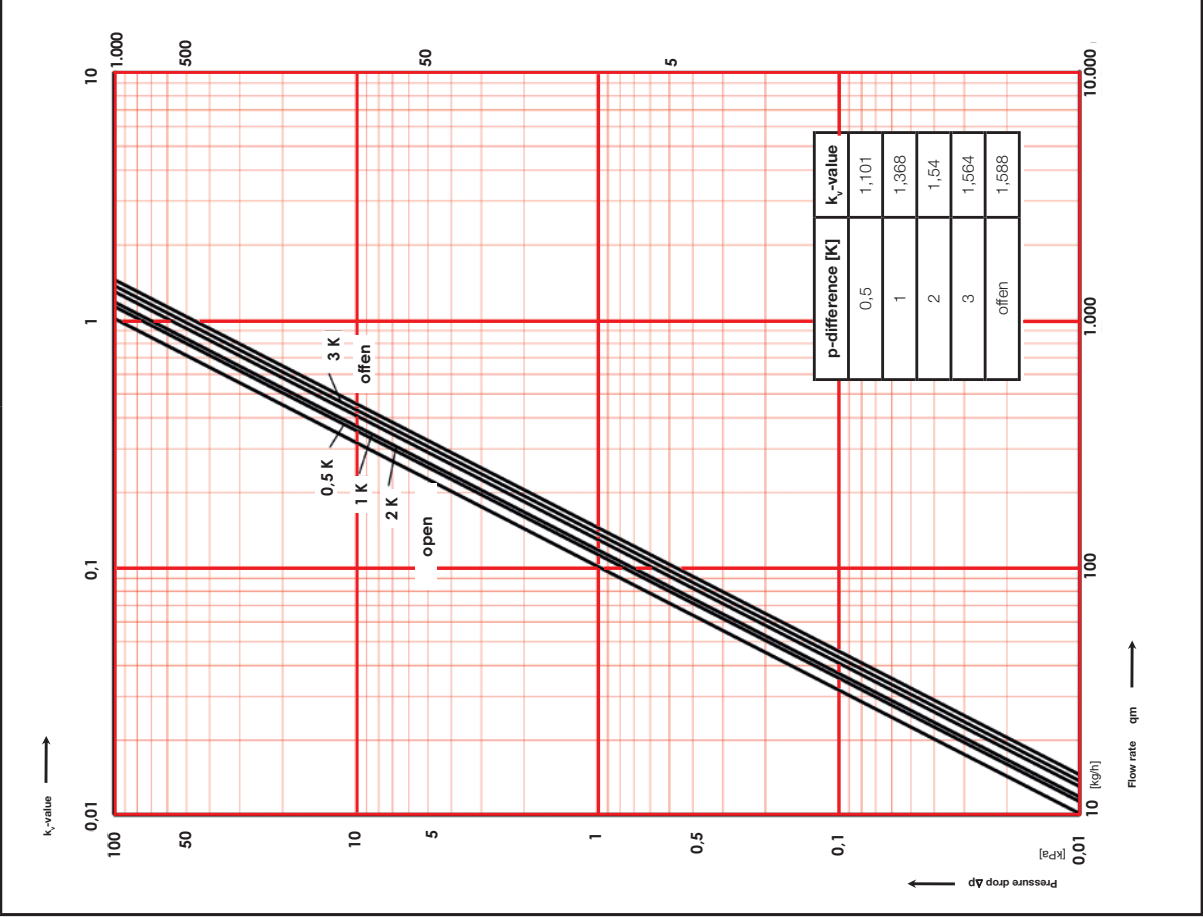

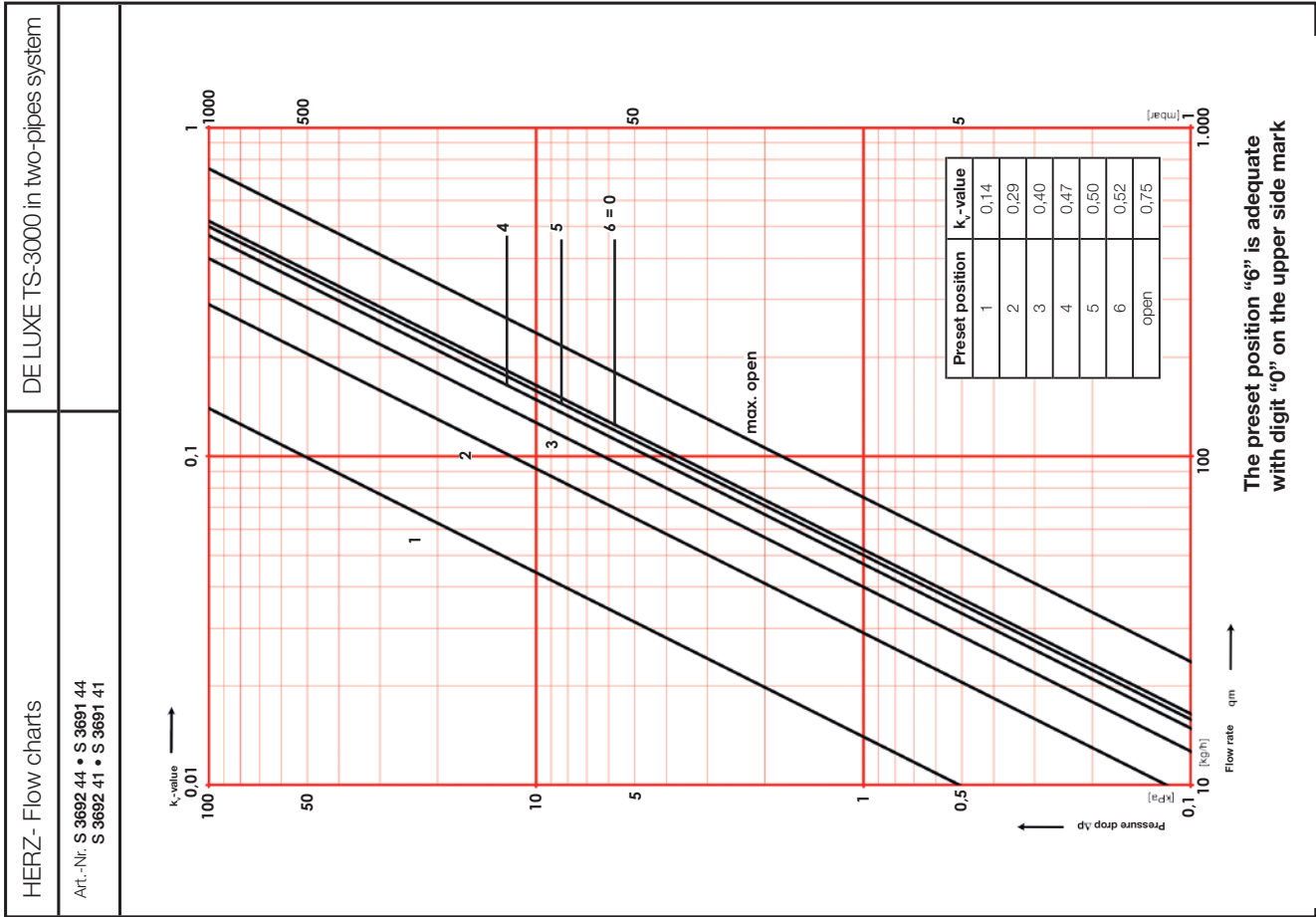

The preset position "6" is adequate with digit "0" on the upper side mark

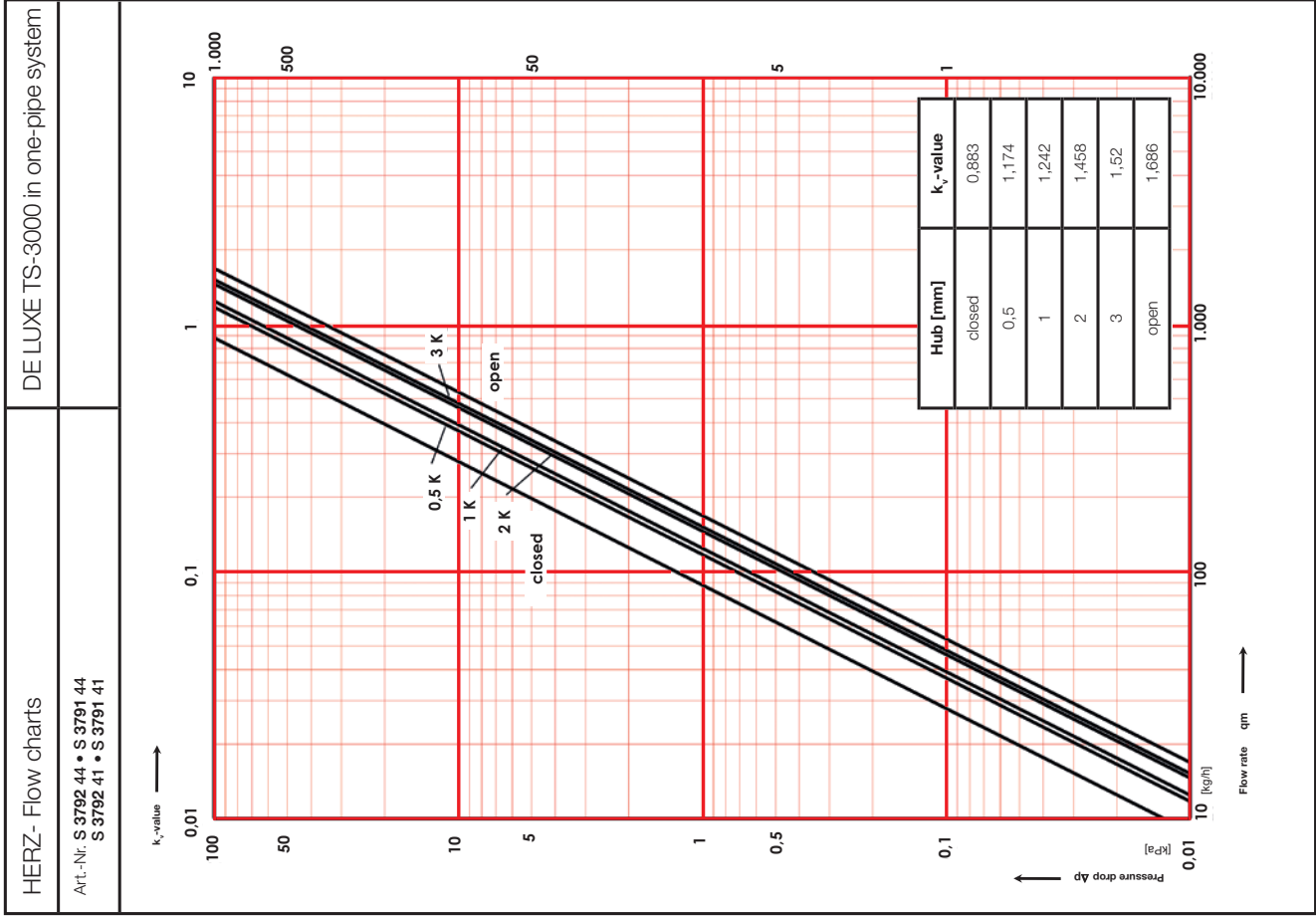

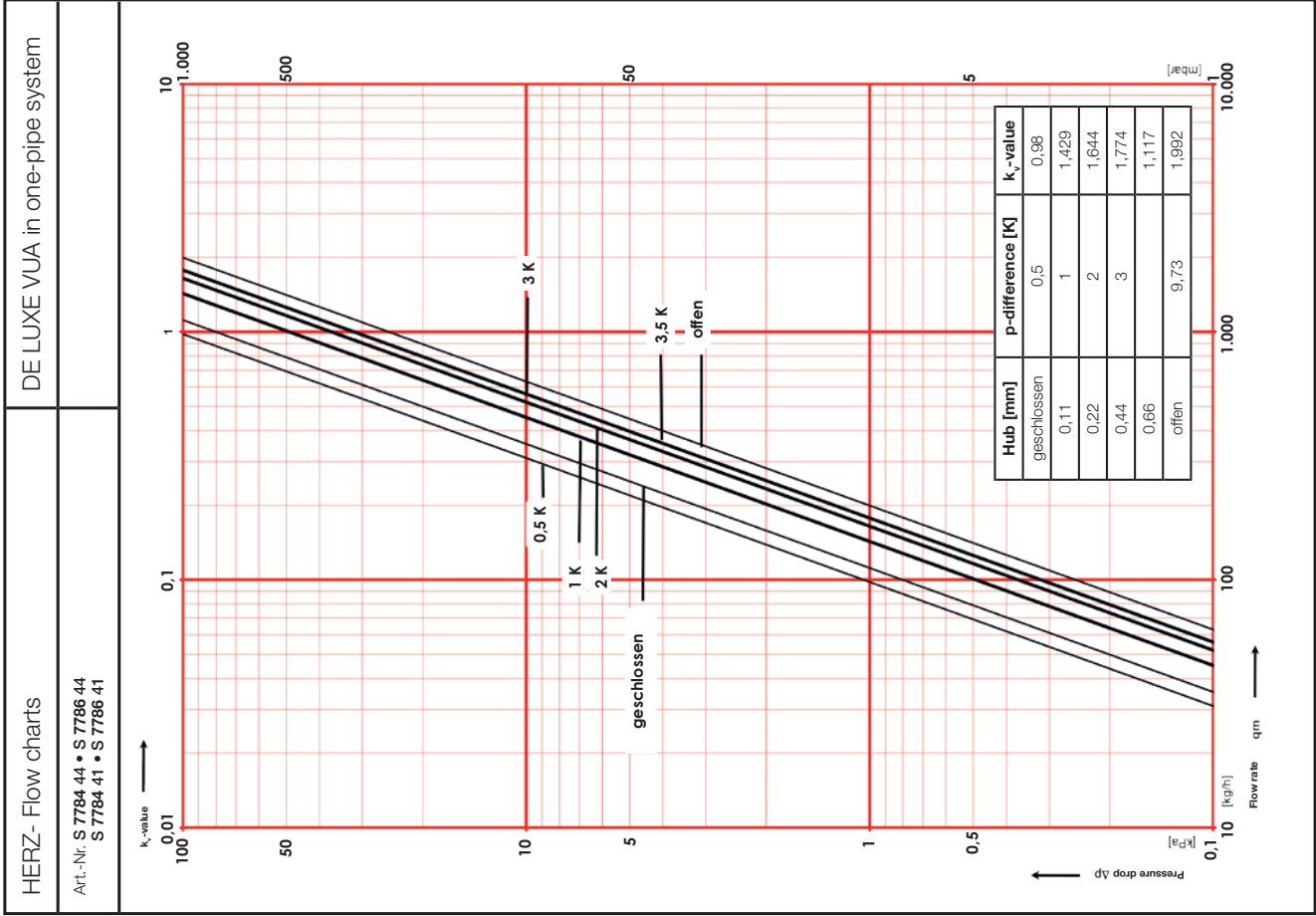
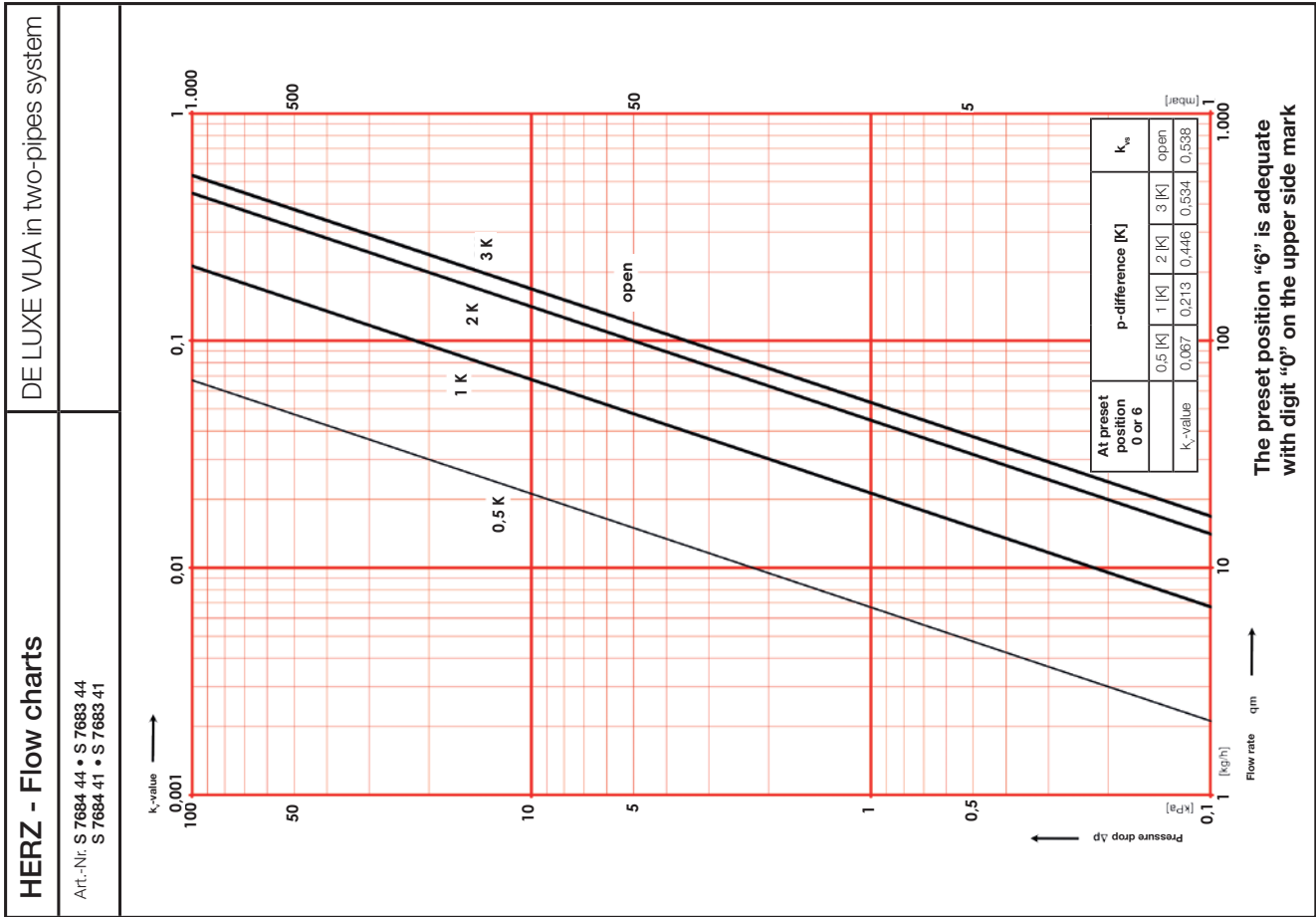



HERZ Valves UK

Progress House, Moorfield Point
Moorfield Road, Slyfield Industrial Estate
Guildford, Surrey GU1 1RU
Tel.: +44 (0)1483 502211, Fax: +44 (0)1483 502025
E-Mail: sales@herzvalves.com
www.herzvalves.com

HERZ Armaturen GmbH

Richard-Strauss-Str. 22, A-1230 Vienna
Tel.: +43 (0)1 616 26 31-0, Fax: +43 (0)1 616 26 31-227
E-Mail: office@herz.eu

www.herz.eu

