

Data sheet collection: Pressure independent control valves

Datasheet HERZ PICV, Issue 0721

General information

This product is only intended for the purpose intended by the manufacturer. This also includes compliance with all associated product regulations. Changes or conversions are not permitted.

Disposal

Local and currently applicable legislation must be observed for disposal.

Note

All schemes are symbolic in nature and do not claim to be complete.

Materials note

Pursuant to Article 33 of the REACH Regulation (EC No. 1907/2006), we are obliged to point out that the material lead is listed on the SVHC list and that all brass components manufactured in our products exceed 0.1% (w / w) lead (CAS: 7439-92-1 / EINECS: 231-100-4). Since lead is a component part of an alloy, actual exposure is not possible and therefore no additional information on safe use is necessary.

HERZ Pressure independent control valves

Datasheet **4006** 1x, 2x, 4x, 6x; **4206** 1x, 2x, 4x, 6x

Dimensions in mm

1 4006 XX

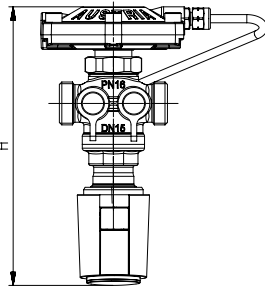
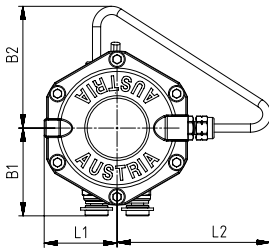
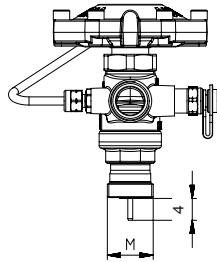
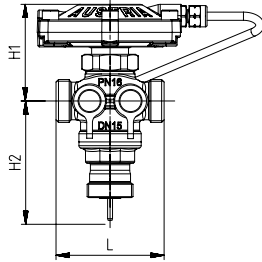

1 4206 XX

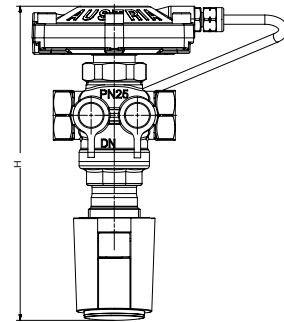
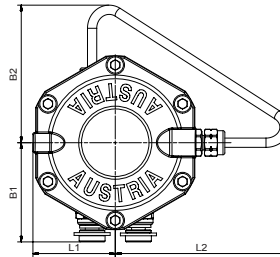
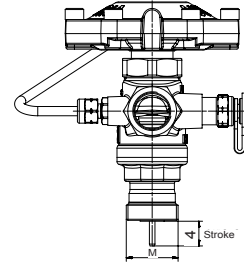
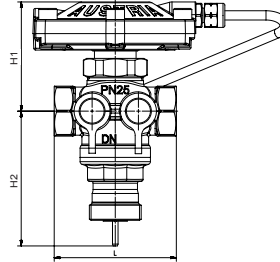

Dimensions in mm

1 4006 XX SMART

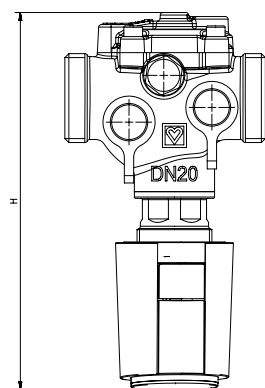
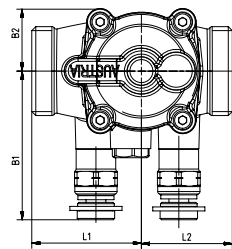
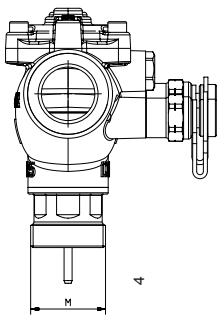
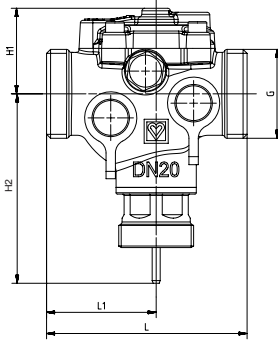

1 4206 XX SMART

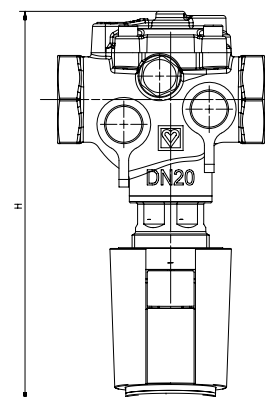
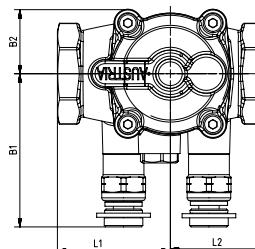
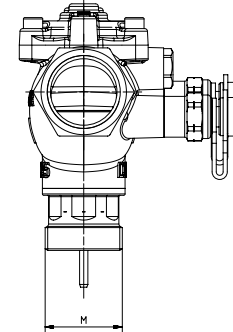
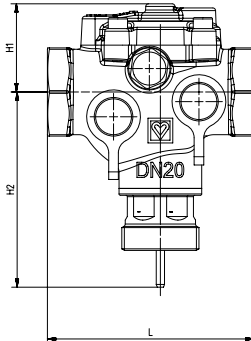

Installation dimensions and order numbers

| Order number | DN | Thread, inch | L, mm | H1, mm | H2, mm | H*, mm | B1, mm | B2, mm | L1, mm | L2, mm | M, mm |
|-----------------|-------|----------------------|-------|--------|--------|--------|--------|--------|--------|--------|-------|
| 1 4006 30 SMART | 15 LF | 3/4 flat sealing | 75 | 35 | 69 | 158,8 | 50 | 23 | 41 | 34 | 28 |
| 1 4006 39 SMART | 15 MF | 3/4 flat sealing | 75 | 35 | 69 | 158,8 | 50 | 23 | 41 | 34 | 28 |
| 1 4006 51 SMART | 15 SF | 3/4 flat sealing | 75 | 32 | 70,9 | 157,7 | 54,6 | 23,3 | 41 | 34 | 28 |
| 1 4006 91 SMART | 15 SF | 3/4 flat sealing | 75 | 32 | 70,9 | 157,7 | 30,6 | 23,3 | 41 | 34 | 28 |
| 1 4006 71 SMART | 15 HF | 3/4 flat sealing | 75 | 32 | 70,9 | 157,7 | 54,6 | 23,3 | 41 | 34 | 28 |
| 1 4006 81 SMART | 15 HF | 3/4 flat sealing | 75 | 32 | 70,9 | 157,7 | 30,6 | 23,3 | 41 | 34 | 28 |
| 1 4006 52 SMART | 20 SF | 1 G flat sealing | 75 | 32 | 70,9 | 157,7 | 55,6 | 23,2 | 41 | 34 | 28 |
| 1 4006 92 SMART | 20 SF | 1 G flat sealing | 75 | 32 | 70,9 | 157,7 | 31,6 | 23,2 | 41 | 34 | 28 |
| 1 4006 72 SMART | 20 HF | 1 G flat sealing | 75 | 32 | 70,9 | 157,7 | 55,6 | 23,2 | 41 | 34 | 28 |
| 1 4006 82 SMART | 20 HF | 1 G flat sealing | 75 | 32 | 70,9 | 157,7 | 31,6 | 23,2 | 41 | 34 | 28 |
| 1 4006 11 | 15 | 3/4 G | 66 | 59 | 75 | 188,8 | 54 | 74 | 45 | 94 | 28 |
| 1 4006 12 | 20 | 1 G | 76 | 60 | 75 | 189,8 | 56 | 72 | 45 | 89 | 28 |
| 1 4006 13 | 25 | 5/4 G flat sealing | 76 | 60 | 75 | 189,8 | 56 | 72 | 45 | 89 | 28 |
| 1 4006 14 | 32 | 1 1/2 G flat sealing | 114 | 76 | 86 | 216,8 | 47 | 76 | 57 | 86 | 28 |
| 1 4006 15 | 40 | 1 3/4 G flat sealing | 132 | 86 | 97 | 237,8 | 47 | 82 | 66 | 85 | 28 |
| 1 4006 16 | 50 | 2 3/8 G flat sealing | 140 | 86 | 97 | 237,8 | 47 | 82 | 70 | 85 | 28 |
| 1 4006 41 | 15 | 3/4 G | 66 | 59 | 75 | 188,8 | 47 | 74 | 45 | 94 | 28 |
| 1 4006 42 | 20 | 1 G | 76 | 60 | 75 | 189,8 | 47 | 72 | 45 | 89 | 28 |
| 1 4006 43 | 25 | 5/4 G flat sealing | 76 | 60 | 75 | 189,8 | 47 | 72 | 45 | 89 | 28 |
| 1 4006 44 | 32 | 1 1/2 G flat sealing | 114 | 76 | 86 | 216,8 | 47 | 76 | 57 | 86 | 28 |
| 1 4006 45 | 40 | 1 3/4 G flat sealing | 132 | 86 | 97 | 237,8 | 47 | 82 | 66 | 85 | 28 |
| 1 4006 46 | 50 | 2 3/8 G flat sealing | 140 | 86 | 97 | 237,8 | 47 | 82 | 70 | 85 | 28 |
| 1 4206 20 SMART | 15 LF | 1/2 | 75 | 35 | 67 | 156,8 | 50 | 23 | 41 | 34 | 28 |
| 1 4206 60 SMART | 15 LF | 1/2 | 75 | 35 | 67 | 156,8 | 26 | 23 | 41 | 34 | 28 |
| 1 4206 29 SMART | 15 MF | 1/2 | 75 | 35 | 67 | 156,8 | 50 | 23 | 41 | 34 | 28 |
| 1 4206 69 SMART | 15 MF | 1/2 | 75 | 35 | 67 | 156,8 | 26 | 23 | 41 | 34 | 28 |
| 1 4206 01 SMART | 15 SF | 1/2 | 75 | 32 | 70,9 | 157,7 | 55,2 | 23,2 | 41 | 34 | 28 |
| 1 4206 91 SMART | 15 SF | 1/2 | 75 | 32 | 70,9 | 157,7 | 31,2 | 23,2 | 41 | 34 | 28 |
| 1 4206 71 SMART | 15 HF | 1/2 | 75 | 32 | 70,9 | 157,7 | 55,2 | 23,2 | 41 | 34 | 28 |
| 1 4206 81 SMART | 15 HF | 1/2 | 75 | 32 | 70,9 | 157,7 | 31,2 | 23,2 | 41 | 34 | 28 |
| 1 4206 02 SMART | 20 SF | 3/4 | 75 | 32 | 70,9 | 157,7 | 55,6 | 23,3 | 41 | 34 | 28 |
| 1 4206 92 SMART | 20 SF | 3/4 | 75 | 32 | 70,9 | 157,7 | 31,6 | 23,3 | 41 | 34 | 28 |
| 1 4206 72 SMART | 20 HF | 3/4 | 75 | 32 | 70,9 | 157,7 | 55,6 | 23,3 | 41 | 34 | 28 |
| 1 4206 82 SMART | 20HF | 3/4 | 75 | 32 | 70,9 | 157,7 | 31,6 | 23,3 | 41 | 34 | 28 |
| 1 4206 11 | 15 | 1/2 | 66 | 59 | 73 | 186,8 | 54 | 74 | 45 | 94 | 28 |
| 1 4206 12 | 20 | 3/4 | 76 | 60 | 73 | 187,8 | 56 | 72 | 45 | 89 | 28 |
| 1 4206 13 | 25 | 1 | 90 | 60 | 73 | 187,8 | 56 | 72 | 45 | 89 | 28 |
| 1 4206 14 | 32 | 1 1/4 | 114 | 76 | 84 | 214,8 | 47 | 76 | 57 | 86 | 28 |
| 1 4206 15 | 40 | 1 1/2 | 132 | 86 | 95 | 235,8 | 47 | 82 | 66 | 85 | 28 |
| 1 4206 16 | 50 | 2 | 140 | 86 | 95 | 235,8 | 47 | 82 | 70 | 85 | 28 |
| 1 4206 41 | 15 | 1/2 | 66 | 59 | 73 | 186,8 | 47 | 74 | 45 | 94 | 28 |
| 1 4206 42 | 20 | 3/4 | 76 | 60 | 73 | 187,8 | 47 | 72 | 45 | 89 | 28 |
| 1 4206 43 | 25 | 1 | 90 | 60 | 73 | 187,8 | 47 | 72 | 45 | 89 | 28 |
| 1 4206 44 | 32 | 1 1/4 | 114 | 76 | 84 | 214,8 | 47 | 76 | 57 | 86 | 28 |
| 1 4206 45 | 40 | 1 1/2 | 132 | 86 | 95 | 235,8 | 47 | 82 | 66 | 85 | 28 |
| 1 4206 46 | 50 | 2 | 140 | 86 | 95 | 235,8 | 47 | 82 | 70 | 85 | 28 |

* with 1 7990 3X actuator

Technical specifications

| | SMART | | | | | | | | | | | |
|--|---|--------------|--------------|-----------|--------------|-----------|-----------|--------|-----------|-----------|-----------|-----------|
| | 15LF | 15MF | 15SF | 15HF | DN20SF | 20HF | DN15 | DN20 | DN25 | DN32 | DN40 | DN50 |
| 1 4006 ..; 1 4206 .. | 20;60 30 | 29; 69 39 | 01;51; 91 | 71; 81 | 02; 52 92 | 72; 82 | 11; 41 | 12; 42 | 13; 43 | 14; 44 | 15; 45 | 16; 46 |
| k_{vs} - value | 0,22 | 0,36 | 1,75 | 2,62 | 2,62 | 3,54 | 1,01 | 2,00 | 3,26 | 5,59 | 9,49 | 9,17 |
| Flowrate @ 100% setting, [l/h] | 120 | 190 | 800 | 1200 | 1200 | 2000 | 430 | 900 | 1900 | 2500 | 5200 | 4820 |
| Max. differential pressure over the valve, bar | 4 | 4 | 6 | 6 | 6 | 6 | 4 | 4 | 4 | 4 | 4 | 4 |
| Operating pressure | max. 25 bar | | | | | | | | | | | |
| Min. operating temperature | 2 °C (pure water); - 20 °C (antifreeze) | | | | | | | | | | | |
| Max. operating temperature | till DN32: 130 °C DN40 - DN50: 110 °C | | | | | | | | | | | |
| Stroke | 4 mm | | | | | | | | | | | |
| Control range | See above, flowrate @ 100% setting | | | | | | | | | | | |
| Water quality | Water purity in accordance with the ÖNORM H 5195 and VDI 2035 standards Ethylene and propylene glycol can be mixed to a ratio of 25 - 50 vol. [%]. | | | | | | | | | | | |

The integrated control unit together with the actuating drive is responsible for modular control. Various actuating drives might be used (see also chapter: Accessories and spare parts).

Materials

| N | Description | Materials |
|--|------------------|------------------------|
| 1 | Housing | DZR brass CC770S |
| 2 | Membrane housing | brass CW602N |
| 3 | Pin | stainless steel 14301 |
| 4 | Membrane | EPDM |
| 5 | O-Rings | EPDM |
| 6 | Spring | spring steel |
| 7 | capillary pipe | copper Cu-DHP (CW024A) |
| 8 | Pin | stainless steel 14301 |
| 9 | Spring | spring steel |
| 10 | Protective cap | plastic |
| Water purity in accordance with the ÖNORM H5195 and VDI 2035 standards | | |

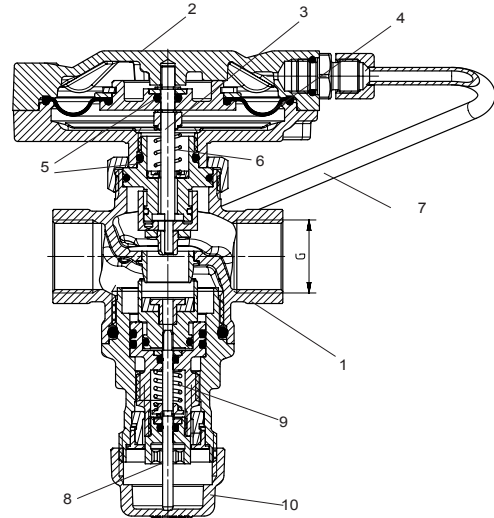

The use of ethylene and propylene glycol in a mixture ratio of 25 - 50% by volume [%] is permitted. Ammonia contained in hemp damages brass valve housings. EPDM seals are swollen by mineral oils or lubricants containing mineral oil and thus lead to failure of the EPDM seals. For frost and corrosion protection agents based on ethylene and propylene glycol can be found in the manufacturer's documentation.

Pursuant to Article 33 of the REACH Regulation (EC No. 1907/2006), we are obliged to point out that the material lead is listed on the SVHC list and that all brass components manufactured in our products exceed 0.1% (w / w) lead (CAS: 7439-92-1 / EINECS: 231-100-4). Since lead is a component part of an alloy, actual exposure is not possible and therefore no additional information on safe use is necessary.

☑ Field of application

The Pressure Independent Balancing Control Valve (PIBCV) is used in all heating and cooling systems with circulation pumps. The valve automatically maintains flow to the required part of the system at the set rate by measuring and immediately adjusting to any variation in pressure. No additional measurements are necessary and the correct flow rate is achieved at all operating conditions. The diaphragm responds to the pressure upstream and downstream of the regulating valve (via an internal impulse line). The valve settings directly affect the volumetric flow through the valve. It is thus possible to set the maximum flow rate based on the flow chart when the valve is fitted. This allows for the balancing of heating circuits, cooling water systems, ceiling cooling and heating panels, air heaters, etc. without any need to first assess the pressure variations in the system. The valve's principal application is as a control valve for terminal units.

☑ System flushing

If it is necessary to flush the system in the direction opposite to the direction of valve's operation, it is important to take into account the maximum allowed differential pressure on the valve for backflushing, equal to 300 kPa. It is also recommended not to exceed the value of the backwash flow more than 3 times the nominal flow rate of the valve.

☑ Installation

The installation takes place in the return, the installation position does not matter. The direction of flow is indicated in the direction of the arrow on the housing. It is recommended to install a shut-off valve before and after the combination valve. The combination valve is shut off with the HERZ setting tool (1 4006 02). The desired flow rate is set in % of the maximum flow rate. Shut off by turning to the right to the stop (display <0% red area).

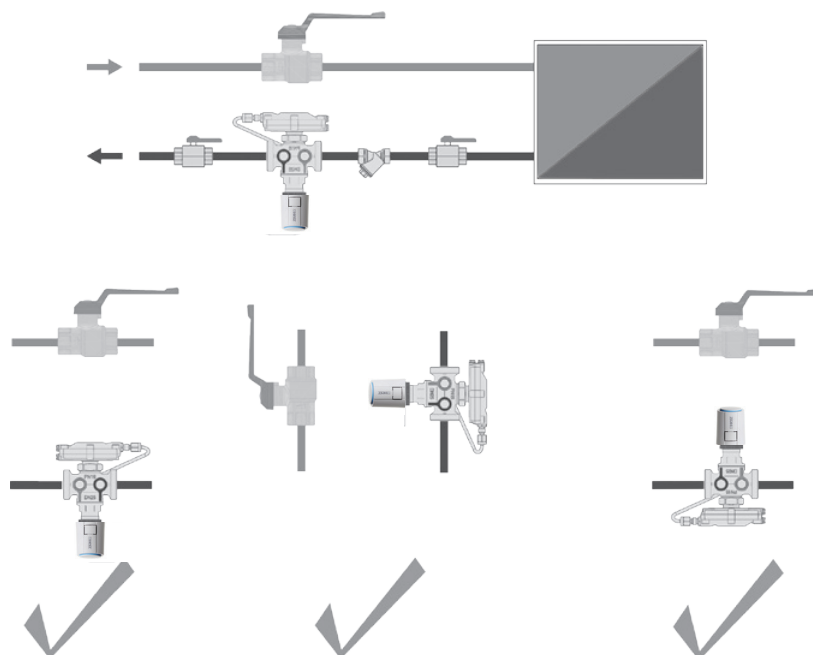

Application field

It is assumed that a consumer needs a volume flow of 300 l/h. The setting value is searched for the HERZ combination valve 4006 DN 15 (1 4006 21/61/11/41). The maximum flow at valve DN 15 is 400 l/h, that

corresponds to the setting 100%: $\frac{300 \text{ l/h}}{400 \text{ l/h}} \times 100 \% = 75 \%$

The 300 l/h is required thus presetting is 75%, which must be set on the valve. A control measurement is then to be carried out. Please note that a minimum differential pressure according to the data sheet must be available for correct operation on the valve.

The HERZ combi valve 4006 is operated with 2-point or continuously acting actuators. However, continuous control is always recommended. The reason for this is that constant and energy-saving control is essential for fast-working systems such as cooling systems or air heaters. Maximum energy savings can only be achieved with regulating valves.

With continuous control, the volume flow is controlled continuously with the slightest fluctuations between minimum and maximum flow. The continuous control also protects all other system-specific components, right down to the pump. The 2-point control is recommended for slow systems such as underfloor heating.

HERZ 4006 PICVs have several advantages over conventional series connection of volume flow controller and differential pressure controller, since the volume flow controller limits the flow depending on the differential pressure of the system, while the differential pressure is variable. If the amount of water is reduced when the room temperature is reached, the differential pressure increases. The resulting operating point is completely different from that of hydraulic balancing. This means that valves connected in series interfere with themselves.

The valve authority for the HERZ combination valve is ideally "1". A valve authority below 0.3 is an ON / OFF control. In order to ensure the efficiency of your system and proper operation, modular control with an authority greater than 0.5 should be aimed for. Since the HERZ valve 4006 compensates for the different differential pressures, the volume flow to the consumer is kept constant. An over or under supply of the individual consumers is therefore excluded.

Hydraulic balancing is always a relevant topic in building technology. The combination valves 4006, 4006 SMART and 4206, 4206 SMART enable the construction of a technical building system with reduced planning effort.

For systems with a large number of PICVs installed, the use of a differential pressure control valves 4002 is recommended to avoid noise problems, the occurrence of water hammer and an unstable system operation.

Application example

Combi valves are used in fan coil heat supply systems. A combination valve is installed in the return of each fan coil and acts as regulating valve.

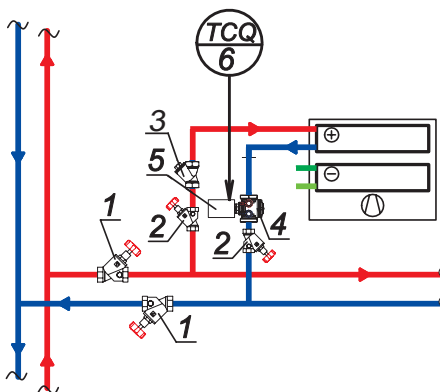
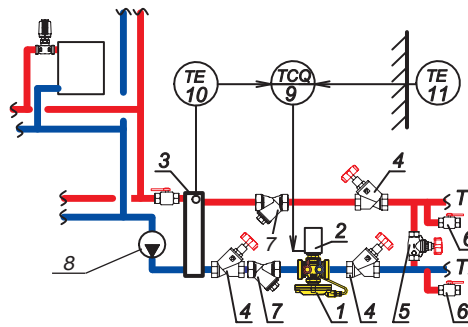

Diagram of a four-pipes fan coil heat supply system (extract)

- 1, 2 - shut-off valve STRÖMAX-A 4115;
- 3 - strainer 4111;
- 4 - PICV 4006 SMART;
- 5 - 7990 thermal actuators;
- 6 - electronic continuous controller.

PICVs in use with a hydraulic distributor.



- 1 - PICV 4006; 2 - 7990 thermal actuator; 3 - hydraulic distributor;
- 4 - shut-off valve STRÖMAX-A 4115;
- 5 - line regulating valve STRÖMAX-GM 4217; 6 - THERMOFLEX 4119 boiler fill and drain valve;
- 7 - strainer 4111; 8 - circulation pump; 9 - electronic continuous controller; 10 - heating water temperature sensor; 11 - Outside temperature sensor.

Valve selection

Select the valve with the smallest dimension that guarantees the necessary nominal flow with an additional safety surcharge. The setting should be as open as possible.

The flow rate calculation is based on the following formula:



$$V = \frac{3600 \times Q}{c \times \rho \times \Delta T} \times 1000, [l/h]$$

V ... volume flow [l / h]
 Q ... heat output [kW]
 c ... specific heat capacity 4.19 [kJ / kgK]
 ρ ... density of water [kg / m³]
 ΔT ... temperature difference flow and return [K]

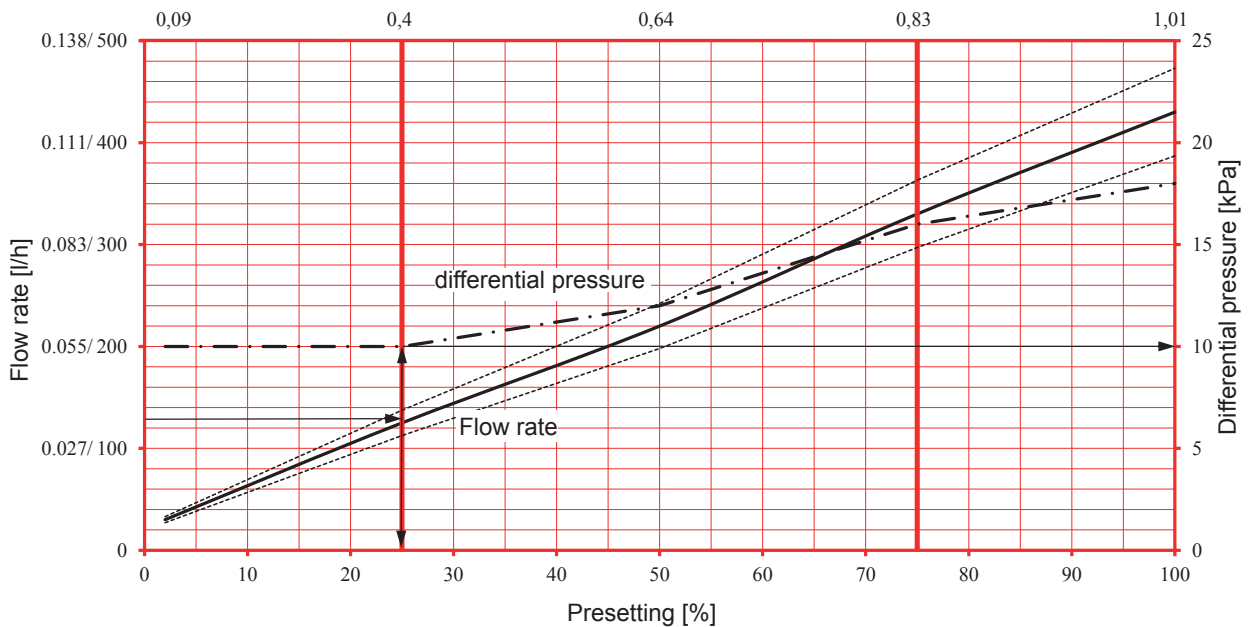

With the help of the kv diagram, the respective minimum differential pressure [kPa] can be determined depending on the flow [l / h] and the default setting [%].



Accessories and spare parts

| Order number | Description | Image |
|--------------|---|---|
| 1 7990 31 | HERZ actuating drive for continuous control M 28 x 1.5, 0..10 V, 5 mm stroke, adapter M 28 x 1.5 colour blue integrated, male connector, cable loose, without limit switch. Closing force 100 N, 1.2 watt. |  |
| 1 7990 32 | HERZ actuating drive for continuous control M 28 x 1.5, 0..10 V, 6.5 mm stroke, adapter M 28 x 1.5 colour blue integrated, male connector, cable loose, without limit switch. Closing force 125 N, 1.2 watt with valve stroke detection. | |
| 1 7708 53 | HERZ actuating drive for 2-point control for floor heating circuit distributors and valves M 28 x 1.5, 2-point, also suitable for pulse-pause operation, 5 mm stroke, adapter M 28 x 1.5 colour red integrated, cable fixed, without limit switch. Closing force 100 N. Power consumption 1 watt. |  |
| 1 7708 52 | HERZ actuating drive for 2-point control for floor heating circuit distributors and valves M 28 x 1.5, 2-point, also suitable for pulse-pause operation, 5 mm stroke, adapter M 28 x 1.5 colour red integrated, cable fixed, without limit switch. Closing force 100 N. Power consumption 1 watt. | |
| 1 7708 40 | HERZ geared motor 3-point Adapter M 28 x 1.5 colour blue integrated, 24 V, stroke distance max. 8.5 mm, max. actuation force 200 N. |  |
| 1 7708 41 | HERZ geared motor 3-point Adapter M 28 x 1.5 colour blue integrated, 230 V, stroke distance max. 8.5 mm, max. actuation force 200 N. | |
| 1 7708 42 | HERZ geared motor DDC 0–10 V Adapter M 28 x 1.5 colour blue integrated, 24 V, stroke distance max. 8.5 mm, max. actuation force 200 N. | |
| 1 7708 46 | HERZ geared motor DDC 0–10 V Adapter M 28 x 1.5 colour blue integrated, 24 V, stroke distance max. 8.5 mm, max. actuation force 200 N. With valve port detection and feedback channel. | |

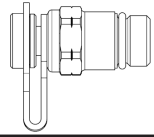
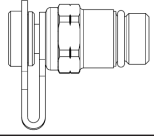
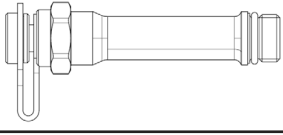
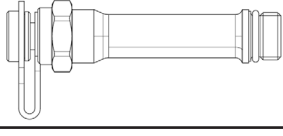
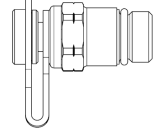
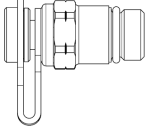
Accessories

| Order number | Dim. | Description | Model |
|--------------|------|---|---|
| 1 0284 01 | 1/4" | Quick test point for combi valve - pressure-independent control valve, brass version, blue cap (return) for pressure transducer. |  |
| 1 0284 02 | 1/4" | Quick test point for combi valve - pressure-independent control valve, brass version, red cap (supply) for pressure transducer |  |
| 1 0284 11 | 1/4" | Quick test point for combi valve - pressure-independent control valve. brass version, blue cap (return) for pressure transducer, extended design for valves with an insulation thickness up to 40 mm. |  |
| 1 0284 12 | 1/4" | Quick test point for combi valve - pressure-independent control valve. brass version, red cap (supply) for pressure transducer, extended design for valves with an insulation thickness up to 40 mm |  |
| 1 0284 05 | 1/8" | Quick test point for combi valve - pressure-independent control valve SMART, brass version, blue cap (return) for pressure transducer |  |
| 1 0284 06 | 1/8" | Quick test point for combi valve - pressure-independent control valve SMART, brass version, red cap (supply) for pressure transducer |  |
| 1 4006 02 | | Pre-setting key HERZ Combi valve pressure-independent control valve for 4006/4206 |  |

Pressetting

The respective setting of the control unit is clearly shown in percentages. The valve is preset with the HERZ setting key (1 4006 02). The desired flow is set in% of the maximum flow. To shut off, turn to the right to <0% (red area).

$$VE [\%] = (\text{Desired flow} / \text{maximum flow}) * 100$$

open = anticlockwise

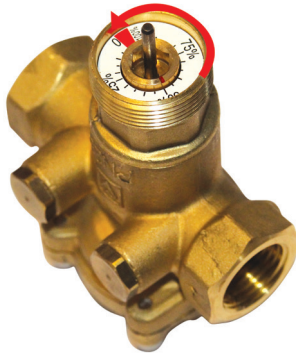

1 4006 02



close = clockwise



How to perform a flow measurement:

- Connect the measuring computer to the measuring nipple
- Enter the dimensions, valve type and setting -> display flow

Warning notices

The valves must be installed for the correct application using clean fittings. A HERZ strainer (4111) should be fitted to prevent impurities

Test points

Two test points are fitted on the same side of the valve and factory sealed. Thanks to this arrangement they are easily accessible and measurement devices can be quickly fitted, no matter in what position the valve has been installed.

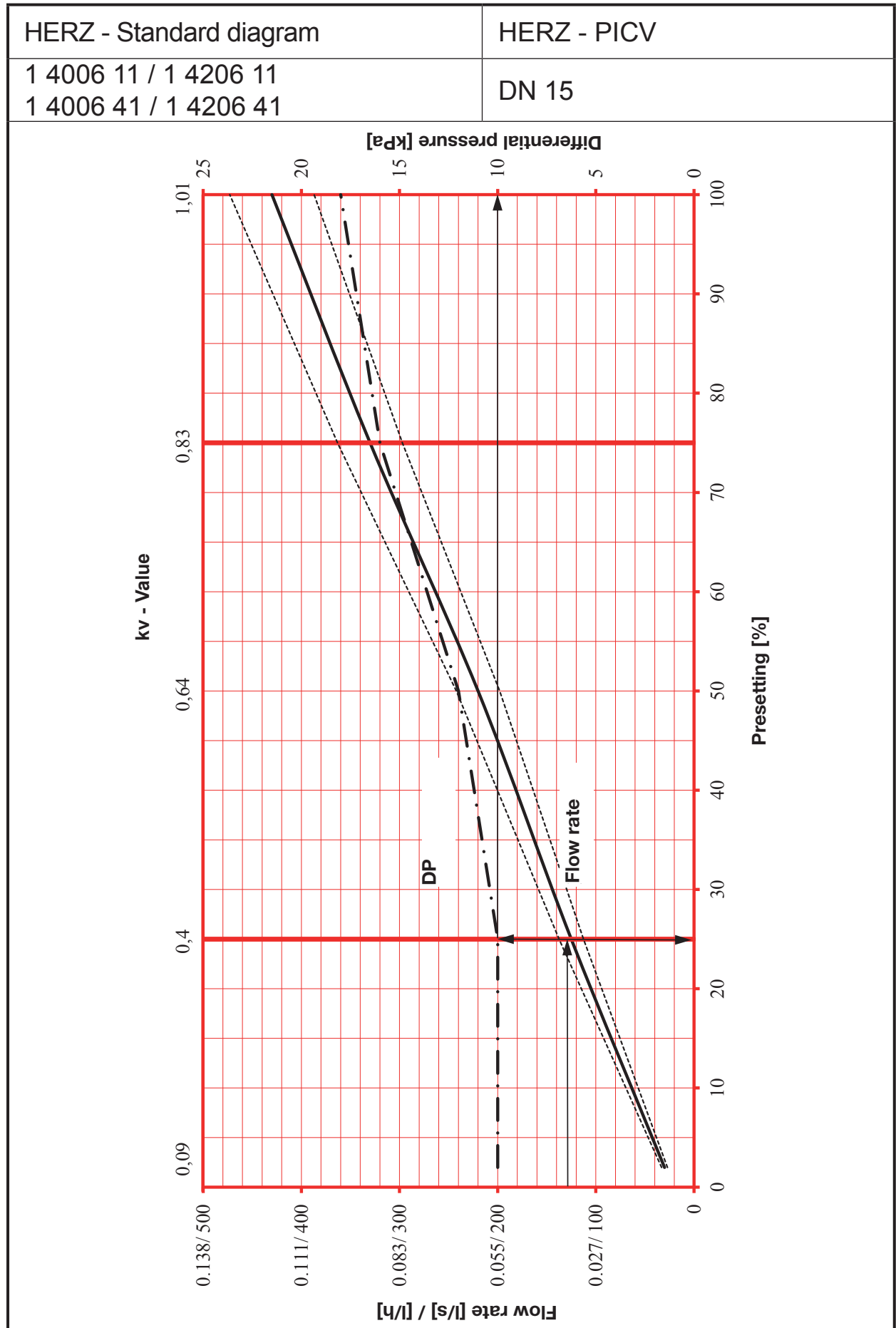

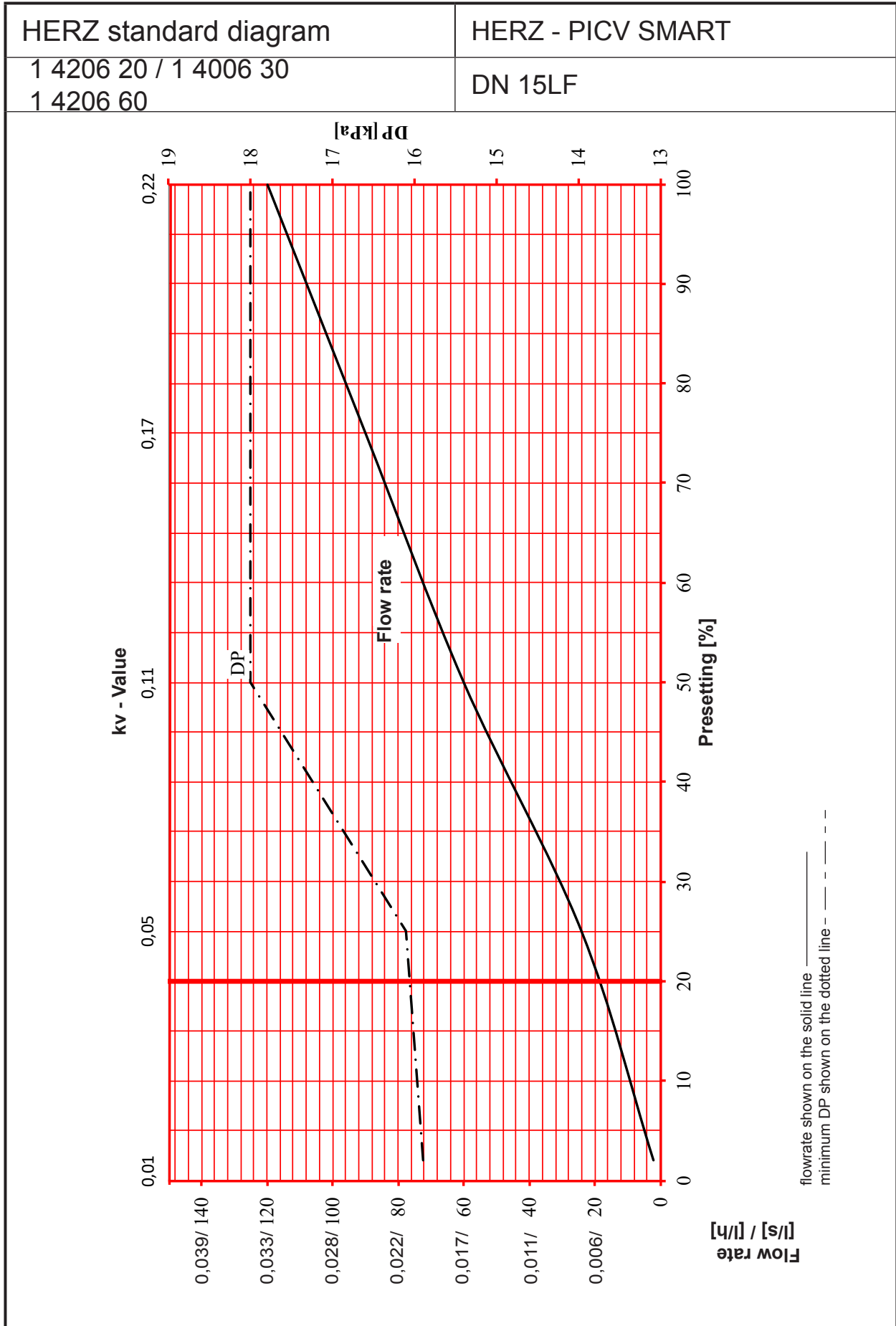

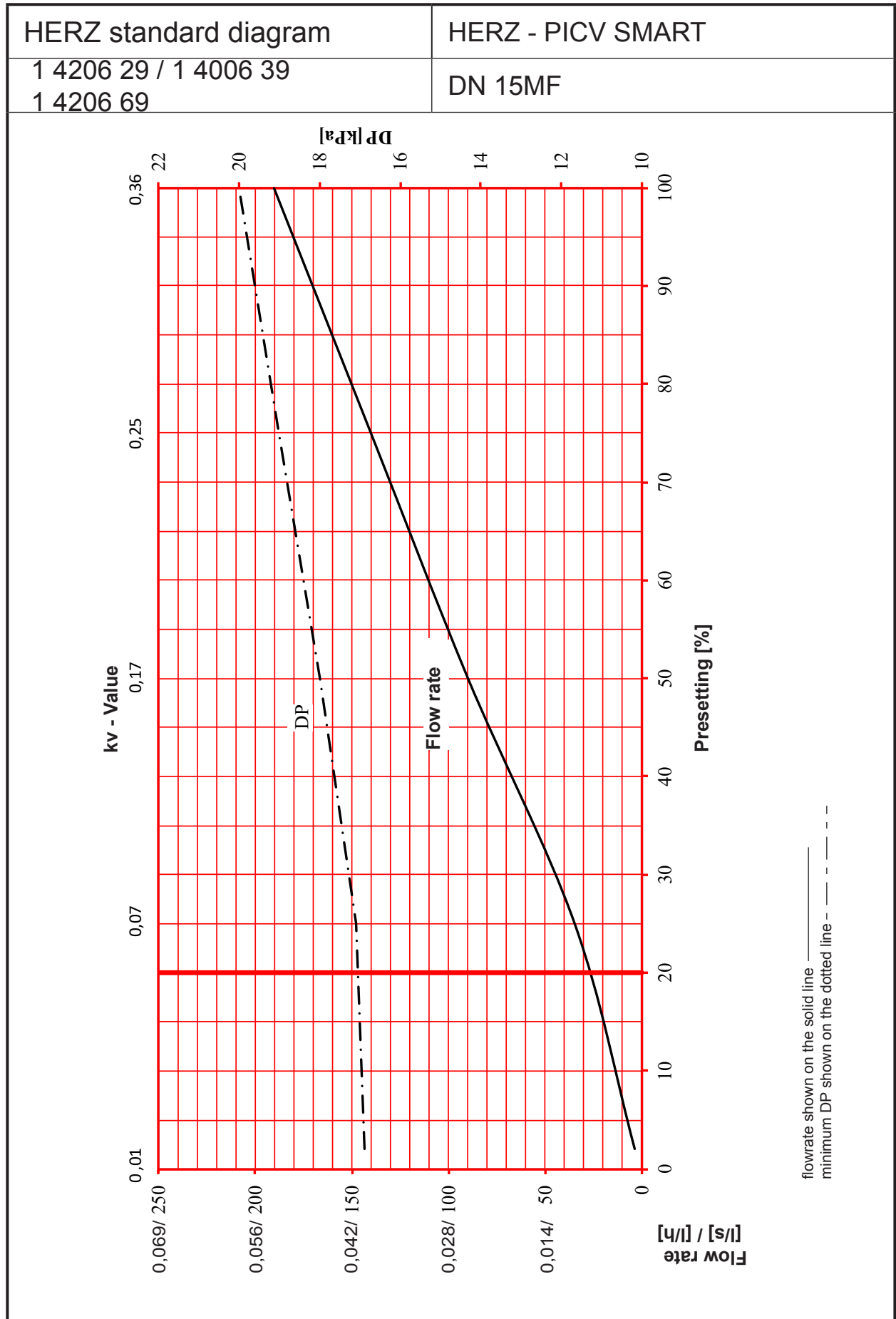

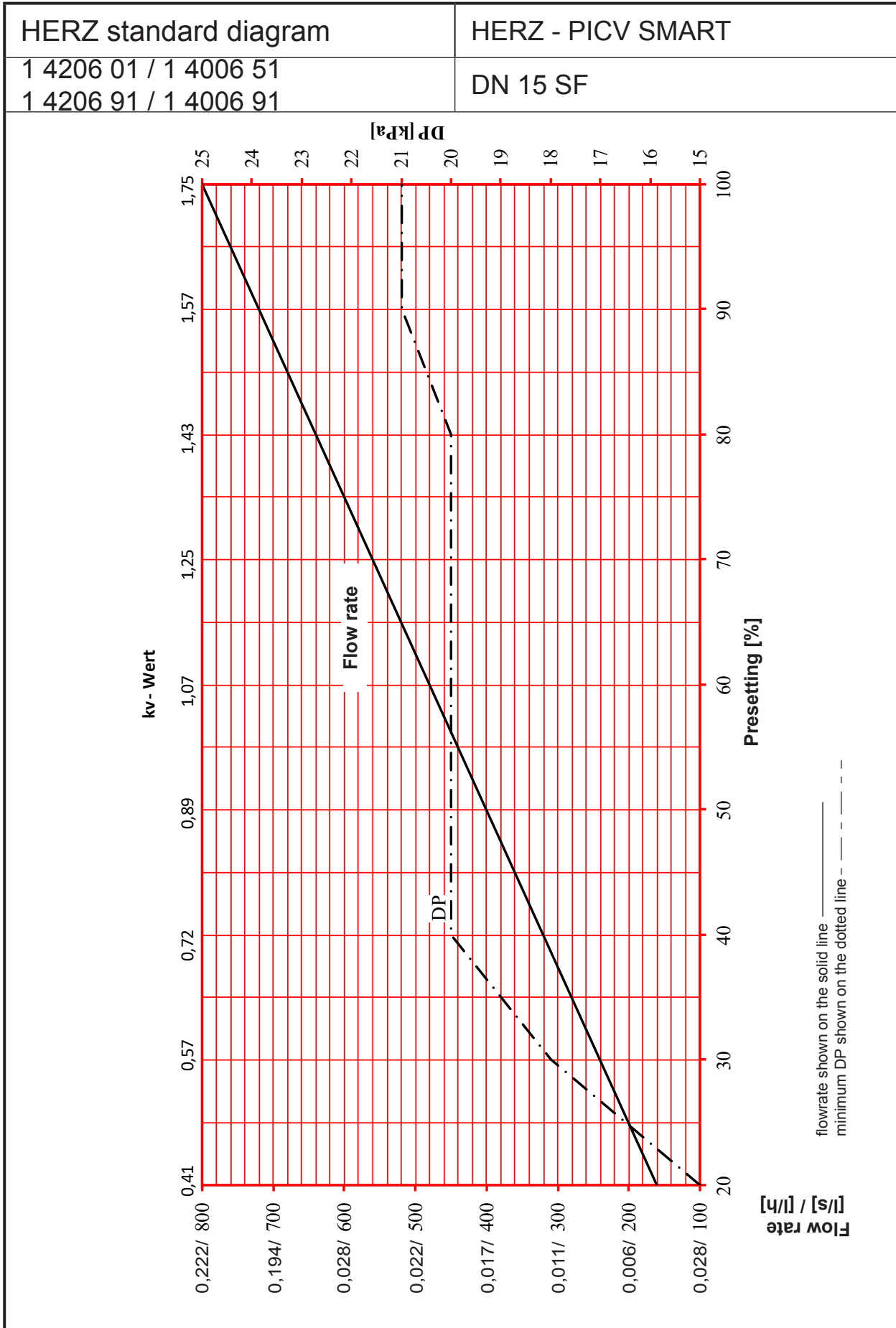

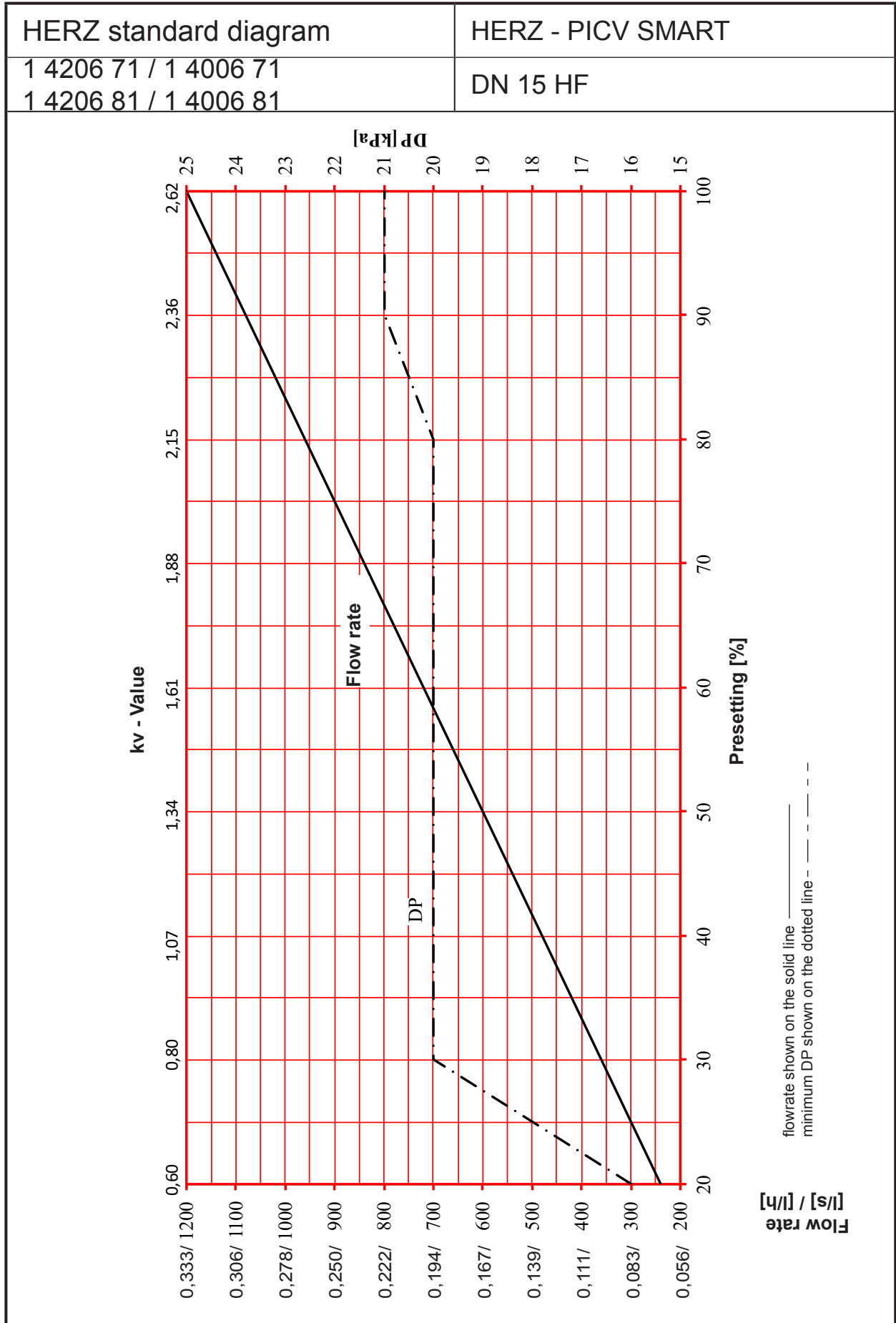

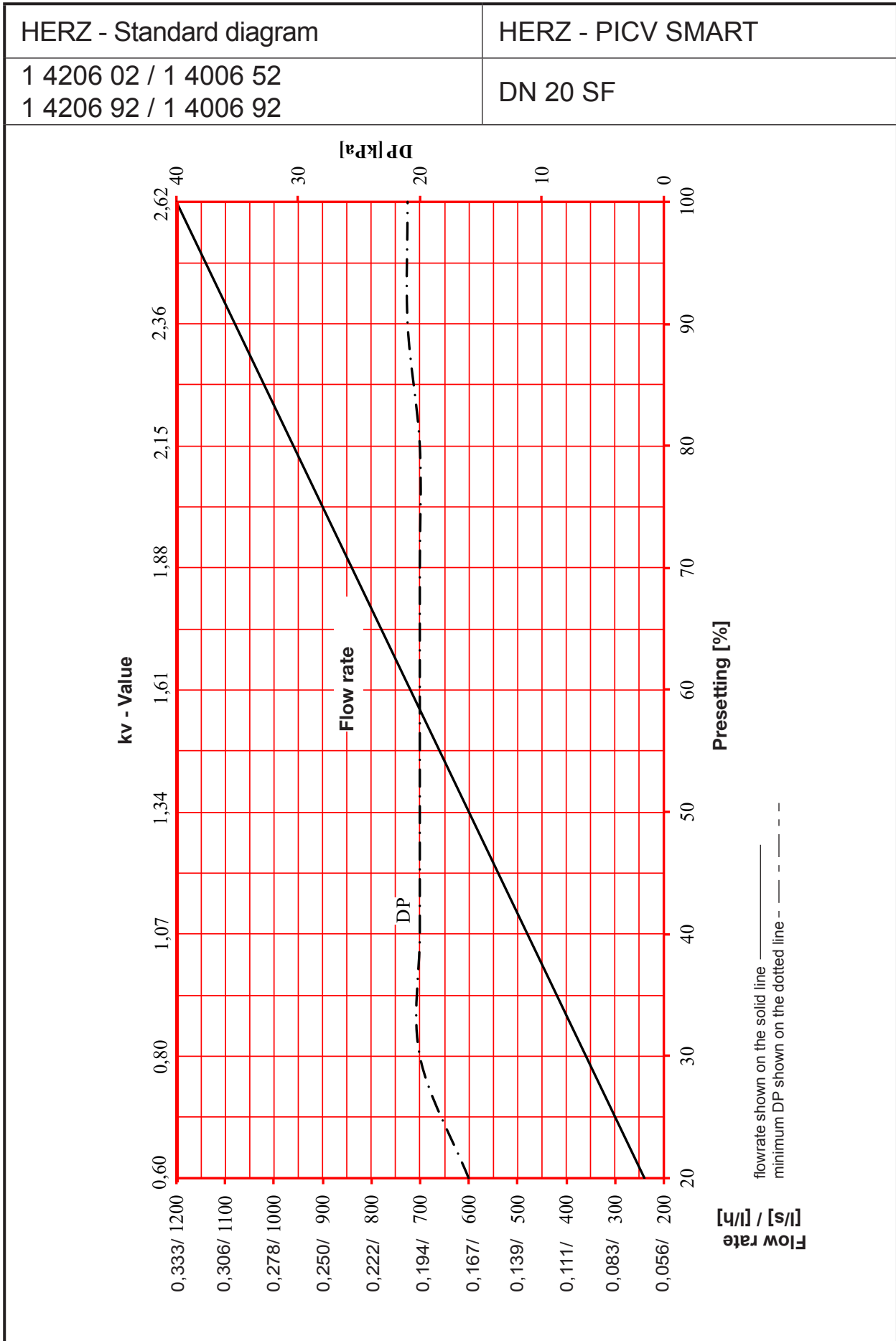

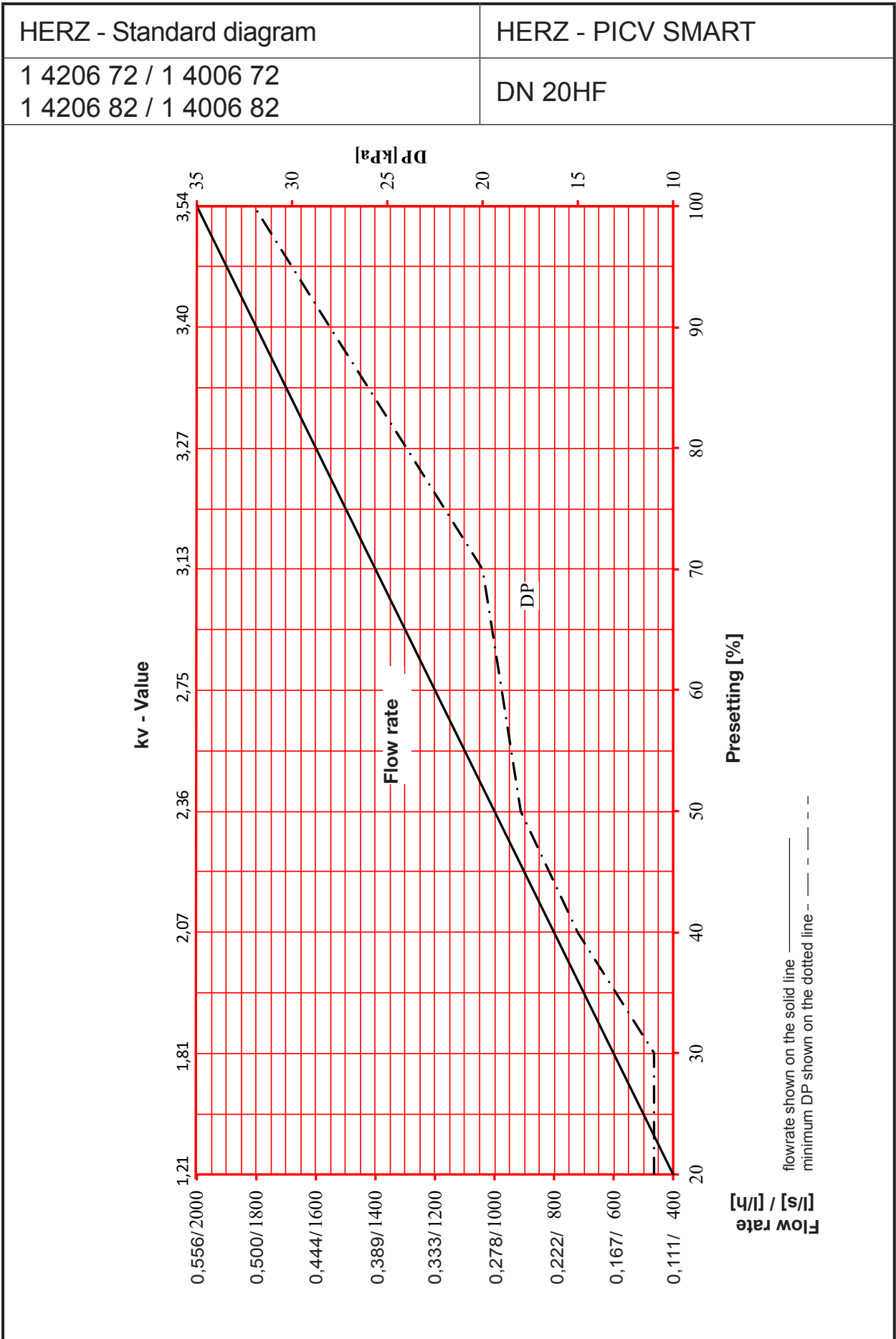

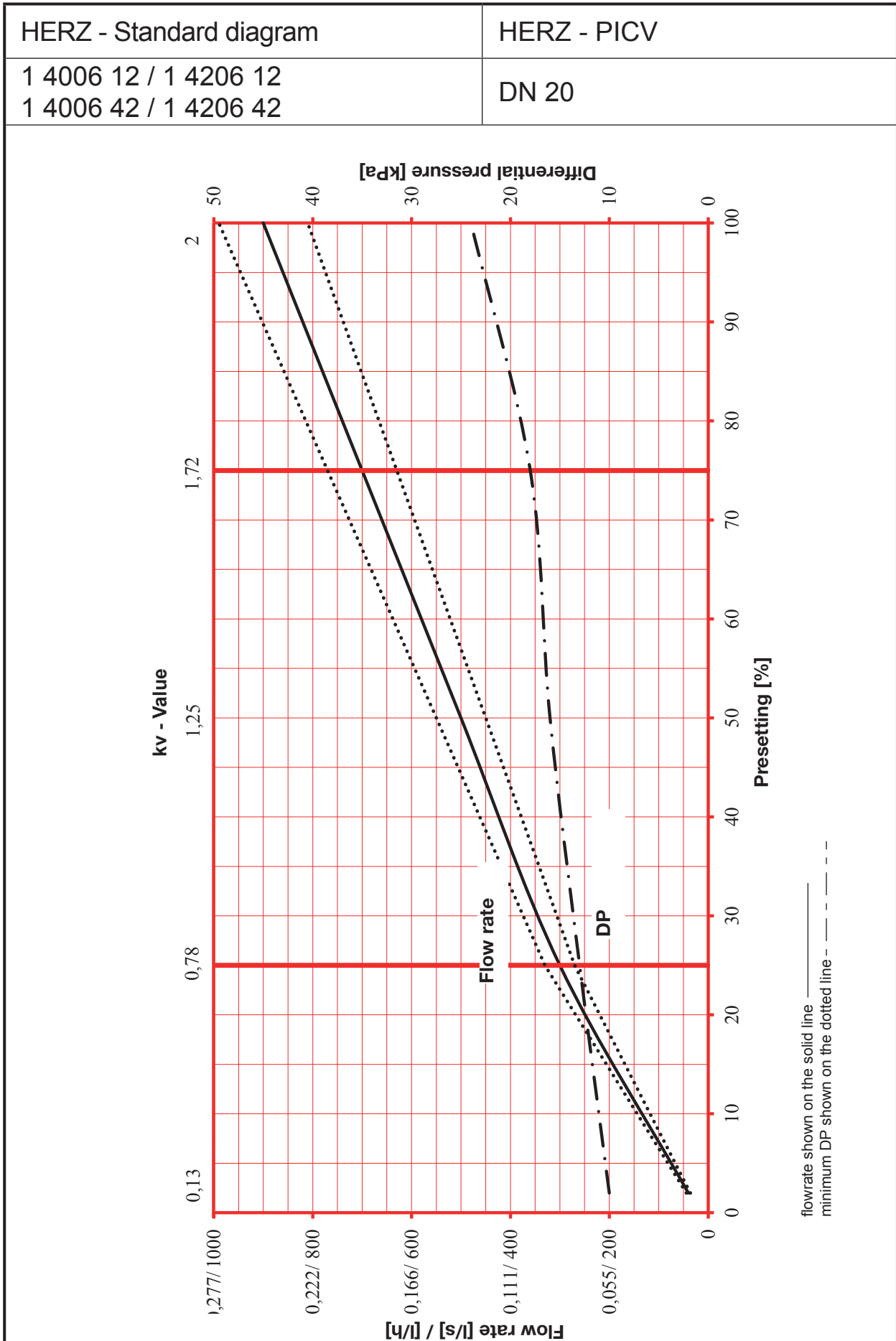

| | |
|--|-------------|
| HERZ - Standard diagram | HERZ - PICV |
| 1 4006 13 / 1 4206 13 1 4006 43 / 1 4206 43 | DN 25 |

