

HERZ-TS 3000

Connection system for radiators

Thermostatic valve and shut-off return valve

Datasheet for HERZ-TS 3000, Issue 0522

☑ Dimensions in mm

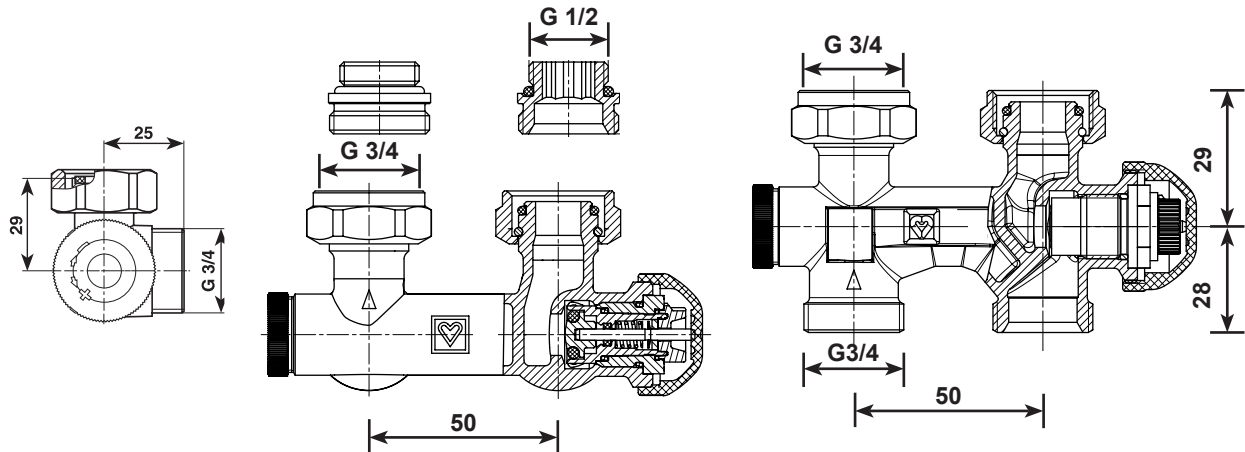

☑ Models

The HERZ-3000 thermostatic valve combines a thermostatic valve and a lockshield valve in one body, whereby the thermostatic sensing element is used in a favourable heat flow position.

Order number	Models	Position of the thermostatic upper part	Connecting thread	Options for thermostat upper part presetting	Type of system	Connecting nipple 1 3002 31	Pipe connection with external thread	Radiator connection
1 3791 92	Straight	-	M28 x 1,5	No	One-pipe	No	G 3/4	G 3/4
1 3792 92	Straight	-	M28 x 1,5	No	One-pipe	Yes	G 3/4	G 1/2
1 3793 92	Angle	Right	M28 x 1,5	No	One-pipe	No	G 3/4	G 3/4
1 3793 82	Angle	Left	M28 x 1,5	No	One-pipe	No	G 3/4	G 3/4
1 3794 92	Angle	Right	M28 x 1,5	No	One-pipe	Yes	G 3/4	G 1/2
1 3794 82	Angle	Left	M28 x 1,5	No	One-pipe	Yes	G 3/4	G 1/2
1 3691 91	Straight	-	M28 x 1,5	Yes	Two-pipe	No	G 3/4	G 3/4
1 3692 91	Straight	-	M28 x 1,5	Yes	Two-pipe	Yes	G 3/4	G 1/2
1 3693 91	Angle	Right	M28 x 1,5	Yes	Two-pipe	No	G 3/4	G 3/4
1 3693 81	Angle	Left	M28 x 1,5	Yes	Two-pipe	No	G 3/4	G 3/4
1 3694 91	Angle	Right	M28 x 1,5	Yes	Two-pipe	Yes	G 3/4	G 1/2
1 3694 81	Angle	Left	M28 x 1,5	Yes	Two-pipe	Yes	G 3/4	G 1/2
1 3798 91	Straight	-	M30 x 1,5	Yes	Two-pipe	Yes	G 3/4	G 1/2
1 3798 92	Straight	-	M30 x 1,5	No	One-pipe	Yes	G 3/4	G 1/2
1 3799 91	Angle	Right	M30 x 1,5	Yes	Two-pipe	Yes	G 3/4	G 1/2
1 3799 81	Angle	Left	M30 x 1,5	Yes	Two-pipe	Yes	G 3/4	G 1/2
1 3799 92	Angle	Right	M30 x 1,5	No	One-pipe	Yes	G 3/4	G 1/2
1 3799 82	Angle	Left	M30 x 1,5	No	One-pipe	Yes	G 3/4	G 1/2

☑ Installation

HERZ-3000 thermostatic valves can be used for all radiators with connection from below, connection centre distance 50 mm, with threaded connection G 3/4 or G 1/2. During mounting, arrows on valve body have to be observed.

☑ Application

Water heating systems for one- and two-pipe systems that are installed with calibrated steel, copper or plastic pipes.

☑ Operational data

Max. operating temperature 120 °C
 Max. operating pressure 10 bar

Heating water quality in accordance with ÖNORM H 5195 or VDI Guideline 2035.

The use of ethylene and propylene glycol in a mixing ratio of 25 - 50 vol [%] is allowed.

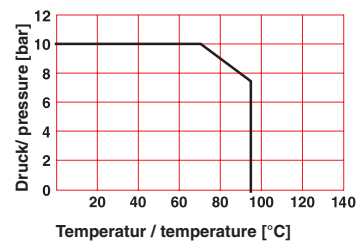

☑ HERZ compression adapters

When using HERZ compression unions for copper and steel pipes, observe the permissible temperatures and pressures as specified in EN 1254-2: 1998 Table 5. The plastic pipe connections are suitable for application classes 4 and 5 according to ISO 10508 (panel heating and radiator connection) and for pipes made of PE-RT (EN ISO 22391), PP (EN ISO 15874), PB (EN ISO 15876) und PE-X (EN ISO 15875). This results in a maximum operating temperature of 95 °C at 10 bar. It is up to the user to select the operating pressure and temperature for the respective pipe type so that the standard values and the permissible operating data of the manufacturer are adhered to.

☑ Pre-assembly

HERZ-3000 thermostatic valves can be pre-assembled to the piping. As soon as flow and return are closed, the system will be filled and a pressure test will be made. After finishing all interior works (painting, decorating), the HERZ thermostatic head is mounted and the radiator is placed. For pre-assembled HERZ-3000 thermostatic valves, it is necessary to cover the raised face and the union nut with security plugs until mounting of radiator will be done.

☑ Shut-off of return valves

Close the valve spindle with the HERZ multi-purpose-key (1 6625 00) or with any allen key 8 mm. The opening is completed after 3 to 3.5 rotations.

☑ Pipe connections G 3/4. To be ordered separately

- 6274 Compression adapter metallic seal, olive with integral O-ring, metallic seal to pipe, union nut G 3/4. Not suitable for chrome-plated metal pipes and stainless steel pipes.
- 6276 Compression adapter with soft seal, olive, solid rubber seal (EPDM) to pipe, union nut G 3/4. Not suitable for chrome-plated metal pipes, soft steel pipes or stainless steel pipes.
- 6098 Plastic pipe connections G 3/4 for PE-X, PB and aluminium composite pipes, consisting of spigot, olive and union nut G 3/4 with cone.

☑ Installation of compression unions to piping

Compression unions are not to be mounted with adjustable pliers or similar tools because this could cause deformation of the union nut. Steel and copper tubes have to be properly calibrated and burred. We recommend using sockets. The union nuts thread has to be oiled with silicone oil. Mineral oils will damage the O-Ring of the olives. Please observe the mounting instructions, enclosed with compression unions.

☑ **Marking of the models**

The valve body is marked with characteristic numbers:

- „1“ - for one-pipe systems
- „2“ - for two-pipe systems

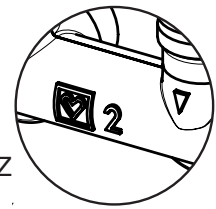

☑ **Replacing the thermostatic upper part**

The thermostatic upper part can be replaced under pressure by means of the HERZ changing tool Changefix 1 **7780** 00. Application according to manual.

- Change of thermostatic upper part to repair failures, e.g. foreign objects like dirt, welding or soldering residues.
- Two-pipe system: Conversion of thermostatic upper parts with fixed or presentable kv-values. Therefore, the volume flow of the radiator can be adjusted according to individual requirements. The setting is done by means of the pre-setting key 1 **6819** 98.



1. Remove HERZ thermostatic head, hand wheel or screw cap.
2. Set the orange adjusting knob (factory setting 6-0 (360° open)) manually or with an pre-setting key (1 **6819** 98) counterclockwise directly to the desired presetting level 5–1.
3. Install HERZ-thermostatic head or hand wheel.

The setting is safely fixed now.

☑ **Spindle seal. One-pipe-model**

The spindle seal is made by means of an O-Ring that is placed in a brass chamber that can be changed during operation. The O-Ring guarantees a maximum level of maintenance-free operation and offers permanent soft running of the valve.

☑ **Change of O-Ring chamber. One-pipe-model**

1. Dismounting of HERZ thermostatic head respectively HERZ-TS-hand wheel.
2. Unscrew the O-Ring chamber including O-Ring and replace it. During the changing process, the upper part has to be hold up with a key. Because of the dismounting process, the valve is automatically open and reverse joint. It is nevertheless possible, that some water drops emerge.
3. Re-mounting in reverse order. Order number for HERZ-TS-O-Ring-Set: 1 **6890** 00

☑ **Mounting instructions. Thermostat**

If radiator and thermostatic valve are covered (curtains, panelling), heat accumulation will be built up. Consequently, the sensing device cannot sense and adjust the room temperature. In this case, use the HERZ-thermostat with remote sensor or remote control. You will find detailed information about HERZ-thermostats in the standard sheets.

☑ **HERZ-TS Hand wheel**

In rare cases where the valve is not equipped with a HERZ thermostatic head, the HERZ-TS-hand wheel will replace the screw cap. During installation, follow the instructions enclosed.

☑ **HERZ Thermostatic valves**

The screw cap is used for operation during the construction period (flushing of piping). Remove the screw cap und unscrew the HERZ-thermostatic head in order to compound the thermostatic valve. Draining of the system is not necessary.

☑ **Nominal lifting**

Setting of nominal lifting by means of screw cap:

At the knurl area of the screw cap two set markings can be found. They are in alignment to the markings “+“ and “-“.

1. Close the valve by means of the screw cap and turn it clockwise.
2. Mark every position that correspond with set marking “+“.
3. Turn screw cap anti-clockwise until set marking “-“ is set to second marked position.

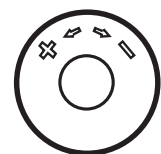

☑ **Summer setting**

After the heating period, open thermostat and turn it anti-clockwise. This prevents dirt adherence on valve seat.

☑ Accessories

☑ Intersection Element in „X“-Model

The special connection is used as intermediate part between bypass body or connection element and piping to adjust pipe distance or radiator. For detailed information, please refer to data sheet “Special connection”.

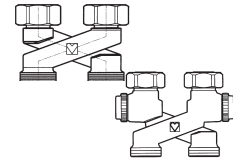

☑ Spacing adapter 1 3004 15

HERZ compensating adapter 3/4 for compensating for different pipe connections in a set of 2 pieces, used for connecting bypass bodies and connecting parts with a mean pipe dimension of 50 mm to pipelines with a mean pipe dimension of 35 or 40 mm.

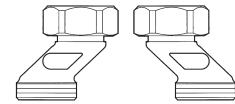
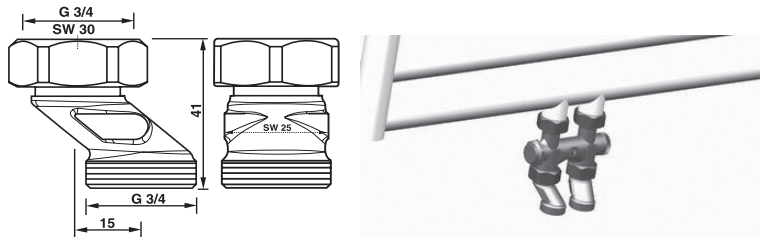

☑ Reversing distributor 1 3030 01 Switch-fix

For connecting the radiator to the pipe network in line with the flow direction and without crossing. The heating supply and return are switchable with the adjusting spindle. The pipelines can be run freely; the adaptation of the radiator flow direction can take place later. The radiator connection can be shut off. Delivery including flush box and cover plate. Connection G 3/4 with cone to radiator. Pipe connection with male thread G 3/4 with cone for compression adapter connection. Compression adapters must be ordered separately. Radiator connection with HERZ valve connection elbow set 1 6333 00 made of 15 x 1 nickel-plated copper pipe. Leg lengths 100 x 100 mm.

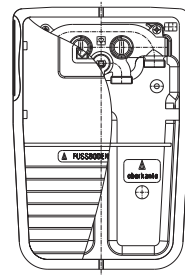

☑ Connection pipe elbow set 1 6333 00

HERZ connection elbow set for two-pipe systems, 100 x 100 mm, can be cut to length, for connecting HERZ connection set and valve radiator. Copper pipes 15 x 1, nickel-plated, with 90° elbow, 2 pieces in a set. Compression adapters for pipe connections must be ordered separately.

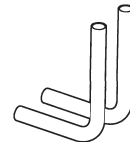

☑ HERZ- design cover, color white (RAL 9010) 1 0115 01

for HERZ-3000 bypass body and connection parts with integrated thermostatic valve; with snap mechanism.

Color traffic white (RAL 9016) 1 0115 02

Color chrom 1 0115 03

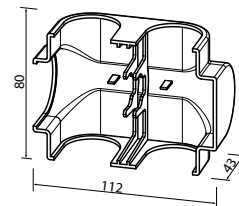

☑ Double connection distributor 1 4133 01

Double connection distributor for two-pipe systems. For crossing-free radiator connection for flush mounting. The radiator connection cannot be shut off. Delivery including flush box and cover plate. Radiator connection G 3/4 with cone. Compression adapters must be ordered separately.

Radiator connection with HERZ valve connection elbow set 1 6332 00 made of 15 x 1 nickel-plated copper pipe. Valves can be shut off and drained, leg length 150 x 150 mm.

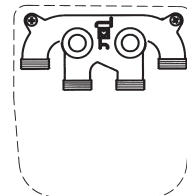

☑ Connection set 1 3031 00

HERZ Connection set for compression adapter connection, nickel-plated brass, for valve radiator and compact radiator. Compression adapter connections: Radiator-side M 22 x 1.5, pipe-side male thread G 3/4. Compression adapters must be ordered separately.
Radiator connection with HERZ valve connection elbow set 1 6332 00 made of 15 x 1 nickel-plated copper pipe. Valves can be shut off and drained, leg length 150 x 150 mm.

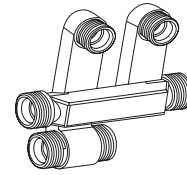

☑ Connection set 1 3032 02, 1 3032 04 and 1 3032 05

HERZ connection set for press connection, short version, nickel-plated brass, for integrated radiator valve and compact radiator. Compression adapters connections on the radiator-side M22x1.5, on the pipe-side press connection DN 16x2 mm - DN 20x2 mm. Compression adapters must be ordered separately.
Radiator connection with HERZ valve connection elbow set 1 6332 00 made of 15 x 1 nickel-plated copper pipe. Valves can be shut off and drained, leg length 150 x 150 mm.

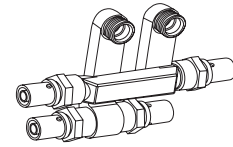

☑ Proportional band

for two-pipe systems

		kv-values							
p-proportional band [K]		0,5	1	1,5	2	2,5	3	3,5	4
	Preset								
	1	0,05	0,11	0,14	0,14	0,14	0,14	0,14	0,14
	2	0,13	0,25	0,29	0,3	0,3	0,3	0,3	0,3
	3	0,14	0,26	0,38	0,42	0,44	0,44	0,45	0,45
	4	0,14	0,27	0,39	0,5	0,54	0,55	0,56	0,57
	5	0,15	0,28	0,4	0,53	0,66	0,7	0,72	0,73
	6	0,15	0,28	0,41	0,56	0,7	0,76	0,8	0,81

for one-pipe systems

☑ Brass

HERZ uses top-quality brass.
Pursuant to Article 33 of the REACH Regulation (EC No. 1907/2006), we are obliged to point out that the material lead is listed on the SVHC list and that all brass components manufactured in our products exceed 0.1% (w / w) lead (CAS: 7439-92-1 / EINECS: 231-100-4). Since lead is a component part of an alloy, actual exposure is not possible and therefore no additional information on safe use is necessary.

☑ Disposal instruction

The disposal of HERZ - 3000 connection system for radiators must not endanger the health or the environment. National legal regulations for proper disposal of the HERZ - 3000 connection system for radiators have to be followed.

Distribution on radiator

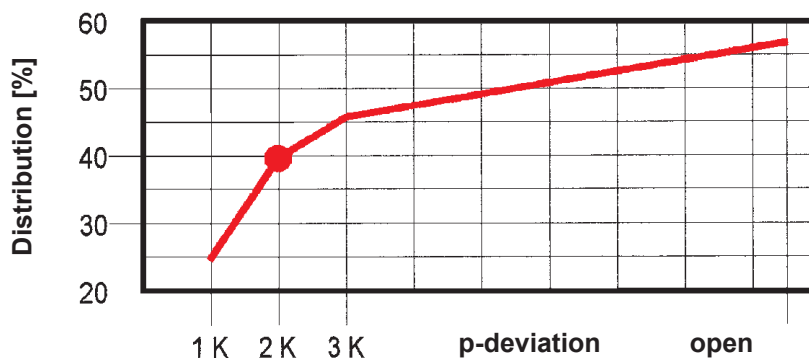

Please note: all diagrams are indicative in nature and do not claim to be complete. All specifications and statements within this document are according to information available at the time of printing and meant for informational purpose only. Herz Armaturen reserves the right to modify and change products as well as its technical specifications and/or its functioning according to technological progress and requirements. It is understood that all images of Herz products are symbolic representations and therefore may visually differ from the actual product. Colours may differ due to printing technology used. In case of any further questions don't hesitate to contact your closest HERZ Branch-office.

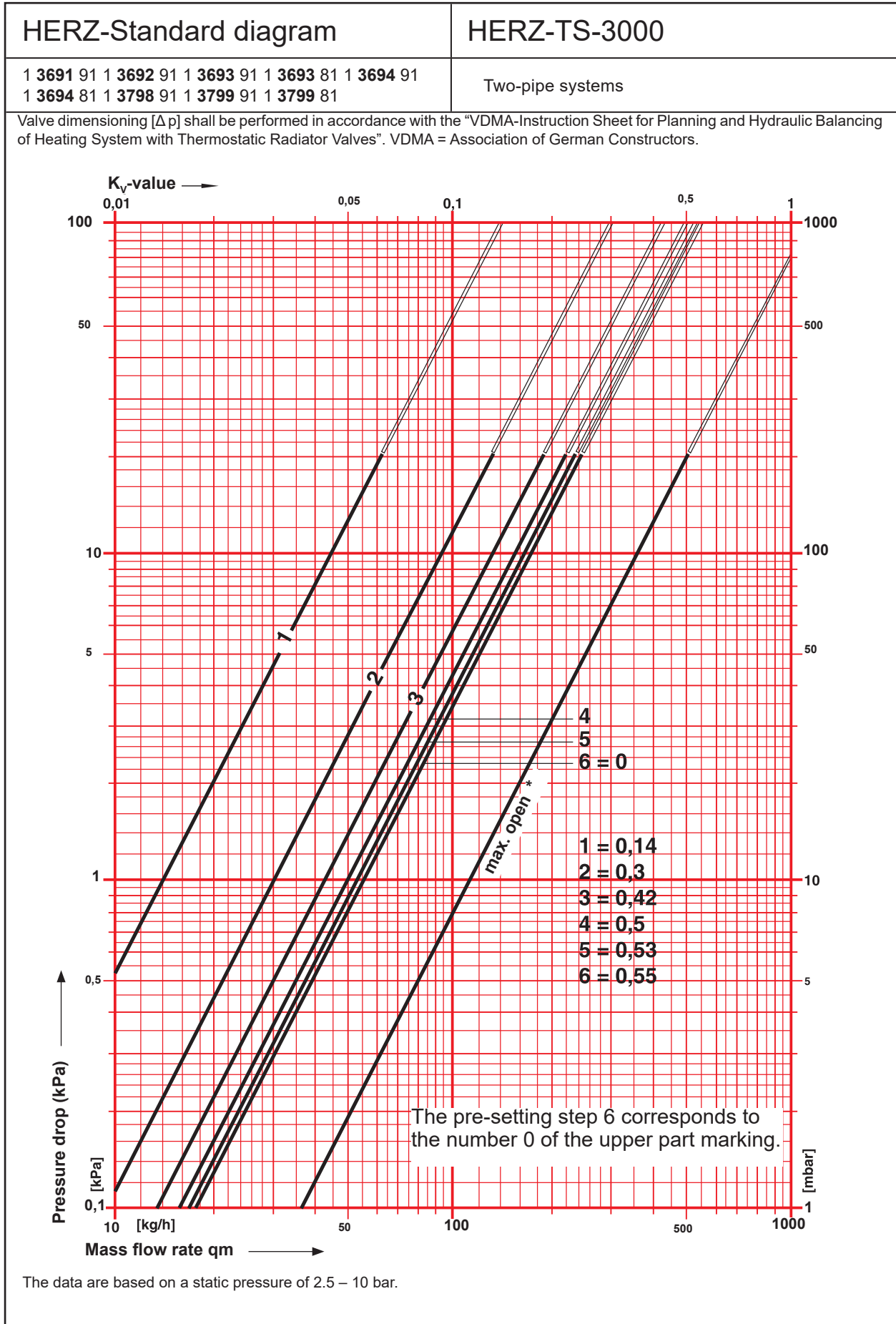

HERZ-Standard diagram	HERZ-TS-3000
------------------------------	---------------------

1 3791 92 1 3792 92 1 3793 92 1 3793 82 1 3794 92 1 3794 82 1 3798 92 1 3799 92 1 3799 82	One-pipe systems
--	------------------

Valve dimensioning [Δp] shall be performed in accordance with the "VDMA-Instruction Sheet for Planning and Hydraulic Balancing of Heating System with Thermostatic Radiator Valves". VDMA = Association of German Constructors.

