

HERZ 7217 V

Integrated Fixed Orifice Control Valve

Data sheet 7217 V, Issue 0322

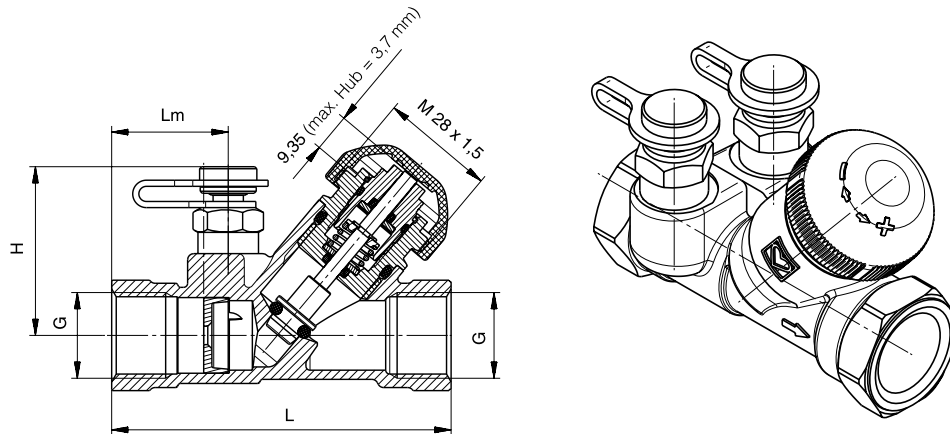

Size in mm

STRÖMAX	Order number	DN	L	Lm	Rp	H	SW	kv	kvs fixed orifice
TS-V LF	1 7217 50	15	83	28,5	1/2	41	27	0,07 - 0,45	0,48
TS-V MF	1 7217 59	15	83	28,5	1/2	41	27	0,32 - 0,88	0,97
TS-V	1 7217 51	15	83	28,5	1/2	41	27	0,51 - 1,70	1,95
TS-V	1 7217 52	20	91	31	3/4	41	32	0,33 - 3,40	3,95

Version

The HERZ 7217TSV combined control, regulating and measuring valve has an integral orifice incorporated into the valve body, socket x socket, with adjustable upper parts, thread M 28 x 1.5 and orange protection cap. Available in sizes from DN15 to DN20. The valve is also available in Low Flow and Medium Flow DN15 versions.

Other Versions

- 1 7217 67 DN 15 Thermostatic Regulating Valve STRÖMAX TS-98-V Straight model with test points, G 3/4" (male thread)
- 1 7217 68 DN 15 Thermostatic Regulating Valve STRÖMAX TS-99-FV Straight model with test points, G 3/4" (male thread)
- 1 7217 71 DN 15 Thermostatic Regulating Valve HERZ-7217-GV Straight model with test points, Rp 1/2" (female thread)
- 1 7217 72 DN 20 Thermostatic Regulating Valve HERZ-7217-GV Straight model with test points, Rp 3/4" (female thread)
- 1 7217 73 DN 25 Thermostatic Regulating Valve HERZ-7217-GV Straight model with test points, Rp 1" (female thread)
- 1 7760 51 DN 15 HERZ-Thermostatic Valve with reverse function, G 3/4" (male thread)
- 1 7760 52 DN 20 HERZ-Thermostatic Valve with reverse function, G 1" (male thread)
- 1 7217 37 DN 15 Thermostatic control valve TS-98-V, straight body with test points, Rp 1/2" (female thread)
- 1 7217 38 DN 15 Thermostatic control valve TS-99-FV, straight body with test points, Rp 1/2" (female thread)

Technical data

Close the valve clockwise with the metal isolating cap 1 **6329 30**. The metal isolating cap must be ordered separately.

Max. operating temperature 130 °C at 10 bar
 Max. operating pressure 20 bar at 20 °C
 Max. Differential pressure on the seat closed with the brass isolating cap 10 bar

Water purity in accordance with the ÖNORM H 5195 and VDI 2035 standards

Ethylene and propylene glycol can be mixed to a ratio of 25 - 50 vol. [%].

HERZ compression adapters for copper and steel pipes, allowable temperature and pressure ratings according to EN 1254-2 1998 Table 5. HERZ plastic pipe connections max. operating temperature 95 °C and max. operating pressure 10 bar, if approved by the pipe manufacturer.

Ammonia contained in hemp can damage brass valve bodies, EPDM gaskets can be affected by Mineral oils lubricants and thus lead to failure of the EPDM seals. Please refer to manufacturers documentation when using ethylene glycol products for frost and corrosion protection.

Application

Heating and Cooling for Fan coils and other terminal units, for control and balancing with high accuracy. Also used as zone control valve for heating and cooling circuits

Special design features

Body is identical with STRÖMAX 4017 M

Flow direction

The flow is observed according to the arrow on the body. There are no special tools required.

Installation

In any orientation.

Integral Fixed Orifice Control Valve 7217 TS-V

Characteristics of the integral fixed orifice

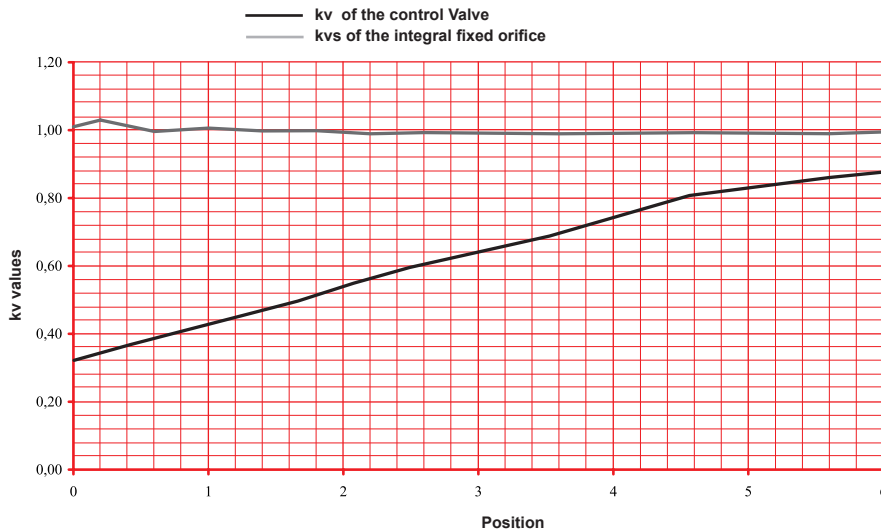

Presetting

The adjustment of the upper part is made by means of HERZ-setting key (1 **6819 72**).

The minimum effective operating position is 0,0 (Closed valve)

DN	15	15-LF	15-MF	20
Position	kv	kv	kv	kv
0,0	0,51	0,07	0,32	0,33
1,0	0,67	0,15	0,43	0,80
2,0	0,96	0,23	0,55	1,70
3,0	1,12	0,31	0,64	2,40
4,0	1,32	0,36	0,74	2,80
5,0	1,50	0,41	0,83	3,10
6,0	1,70	0,45	0,88	3,40

Selection of the valve

It should be noted that the default setting of the upper control part is not less than 1/4 of the total stroke.

Actuators

1 7990 31	24 V	DDC actuating drive for continuous control
1 7990 32	24 V	DDC actuating drive with valve stroke recognition
1 7708 XX	230 V or 24 V	HERZ-Actuating drive for 2, 3-point or pulse control

 Pipe connection with clamping sets for copper and mild steel pipes

The regulating valves can either be connected to a threaded pipe or to a calibrated copper pipe using a clamp set. Clamp sets must be ordered separately.

Pipe diameter mm

	8	10	12	14	15	16	18
Valve DN	15						
Adapter	1 6266 01	1 6266 01	1 6266 01	1 6266 01	1 6266 01	1 6266 01	1 6266 01
Clamp set	1 6274 18	1 6274 00	1 6274 01	1 6274 02	1 6274 03	1 6274 04	
Clamp set			1 6276 12	1 6276 14	1 6276 15	1 6276 16	1 6276 18

Pipe diameter mm

	8	10	12	14	15	16	18	22
Valve DN	20							
Adapter	1 6266 20	1 6266 20	1 6266 20	1 6266 20	1 6266 20	1 6266 20	1 6266 20	1 6266 13
Clamp set	1 6274 18	1 6274 00	1 6274 01	1 6274 02	1 6274 03	1 6274 04		1 6273 01
Clamp set			1 6276 12	1 6276 14	1 6276 15	1 6276 16	1 6276 18	

When installing soft steel or copper pipes with a clamp set, we recommend using support sleeves. The thread of the clamping ring screw or nut as well as the clamping ring itself are to be oiled with silicone oil. We refer to our processing instructions.

 Plastic pipe connection

The regulating valves can be used in systems with plastic pipes. Adapters and plastic pipe connections are mounted on the special sleeves.

Pipe diameter mm

	14 x 2	16 x 2	16 x 2,2	17 x 2	17 x 2,5	18 x 2	18 x 2,5	20 x 2	20 x 2,5	20 x 3,5
Valve DN	15									
Adapter	1 6266 01	1 6266 01	1 6266 01	1 6266 01	1 6266 01	1 6266 01	1 6266 01	1 6266 01	1 6266 01	1 6266 01
Clamp set	1 6098 02	1 6098 03	1 6098 12	1 6098 04	1 6098 05	1 6098 07	1 6098 06	1 6098 08	1 6098 11	1 6098 10

Pipe diameter mm

	14 x 2	16 x 2	16 x 2,2	17 x 2	17 x 2,5	18 x 2	18 x 2,5	20 x 2	20 x 2,5	20 x 3,5
Valve DN	20									
Adapter	1 6266 20	1 6266 20	1 6266 20	1 6266 20	1 6266 20	1 6266 20	1 6266 20	1 6266 20	1 6266 20	1 6266 20
Clamp set	1 6098 02	1 6098 03	1 6098 12	1 6098 04	1 6098 05	1 6098 07	1 6098 06	1 6098 08	1 6098 11	1 6098 10

☑ Spare parts

1 0284 01	1/4	test point for HERZ circuit control valve, blue cap (return)
1 0284 02	1/4	test point for HERZ circuit control valve, red cap (flow)
1 0284 11	1/4	test point for HERZ circuit control valve, extended model, blue cap (return)
1 0284 12	1/4	test point for HERZ circuit control valve, extended model, red cap (flow)
1 0284 22	1/4	HERZ test point with draining function, red cap (flow)
1 0284 21	1/4	HERZ test point with draining function, blue cap (return)
1 6305 5X		Replacement upper part

☑ Measuring

Integral Fixed Orifice Control Valves must always be installed with a minimum of 10 pipe diameters of straight pipe, without intrusion, upstream of the orifice plate. Downstream of the valve a minimum of 5 pipe diameters of straight pipe are required.

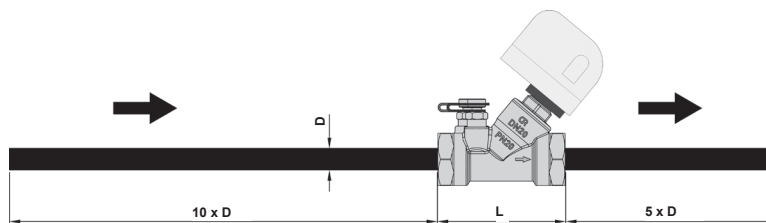

☑ Warning notices

The valves must be installed for the correct application using clean fittings.

Please avoid introducing any dirt into the system when installing the valve.

Screw the pipe into the valve and with a suitable assembly tool taking care to support the valve during tightening to avoid distortion.

The installation of the valve should be carried out by competent trained professionals. Sealing materials should be used to seal the connection between the pipe and the valve. If space is restricted, the valve upper part can be removed during installation. When reassembling the upper part excessive tightening of the valve upper part is not necessary as the upper part is sealed with an O ring.

Test points

Two test points are fitted on the same side of the valve and factory sealed. This arrangement ensures the best accessibility in any position and optimum connection of measuring instruments.

☑ Measuring valves

Two measuring valves are mounted next to the handwheel in the same direction and sealed in the factory. This arrangement guarantees the best accessibility and optimal connection of measuring devices in all installation positions.

☑ Measuring computer

1 8900 05 HERZ-Measuring computer HerzCOMP 650

Correction factors must be used for systems with frost protection. The water-glycol mixture has a different viscosity than pure water and is also temperature-dependent. When measuring with the measuring computer, the displayed measured value is therefore falsified.

Correction factors for glycol mixtures when measuring with the HERZ-Flowplus

Temperature °C	Ethylene glycol 34% (Factor)	Ethylene glycol 40% (Factor)	Ethylene glycol 44% (Factor)
-20	1,98	2,133	2,235
-15	1,833	1,9908	2,096
-10	1,737	1,8738	1,965
-5	1,649	1,7702	1,851
0	1,567	1,6744	1,746
5	1,482	1,5876	1,658
10	1,412	1,505	1,567
15	1,342	1,4254	1,481
20	1,281	1,3554	1,405
25	1,226	1,2956	1,342
30	1,163	1,2284	1,272
35	1,123	1,1848	1,226
40	1,079	1,136	1,174
45	1,04	1,0928	1,128
50	1	1,0528	1,088
55	0,974	1,0214	1,053
60	0,947	0,9938	1,025
65	0,926	0,9714	1
70	0,912	0,9528	0,98
75	0,893	0,9332	0,96
80	0,884	0,9242	0,951

$$dP_R / f = dP_{\text{Display}}$$

$$Q_R / \sqrt{f} = Q_{\text{Display}}$$

dP_R	Differential pressure really
dP_{Display}	Differential pressure on the display
Q_R	Flow rate really
Q_{Display}	Flow rate am Display
f	Factor from the table above

Disposal

Local and currently applicable legislation must be observed for disposal.

Materials note

Pursuant to Article 33 of the REACH Regulation (EC No. 1907/2006), we are obliged to point out that the material lead is listed on the SVHC list and that all brass components manufactured in our products exceed 0.1% (w / w) lead (CAS: 7439-92-1 / EINECS: 231-100-4). Since lead is a component part of an alloy, actual exposure is not possible and therefore no additional information on safe use is necessary.

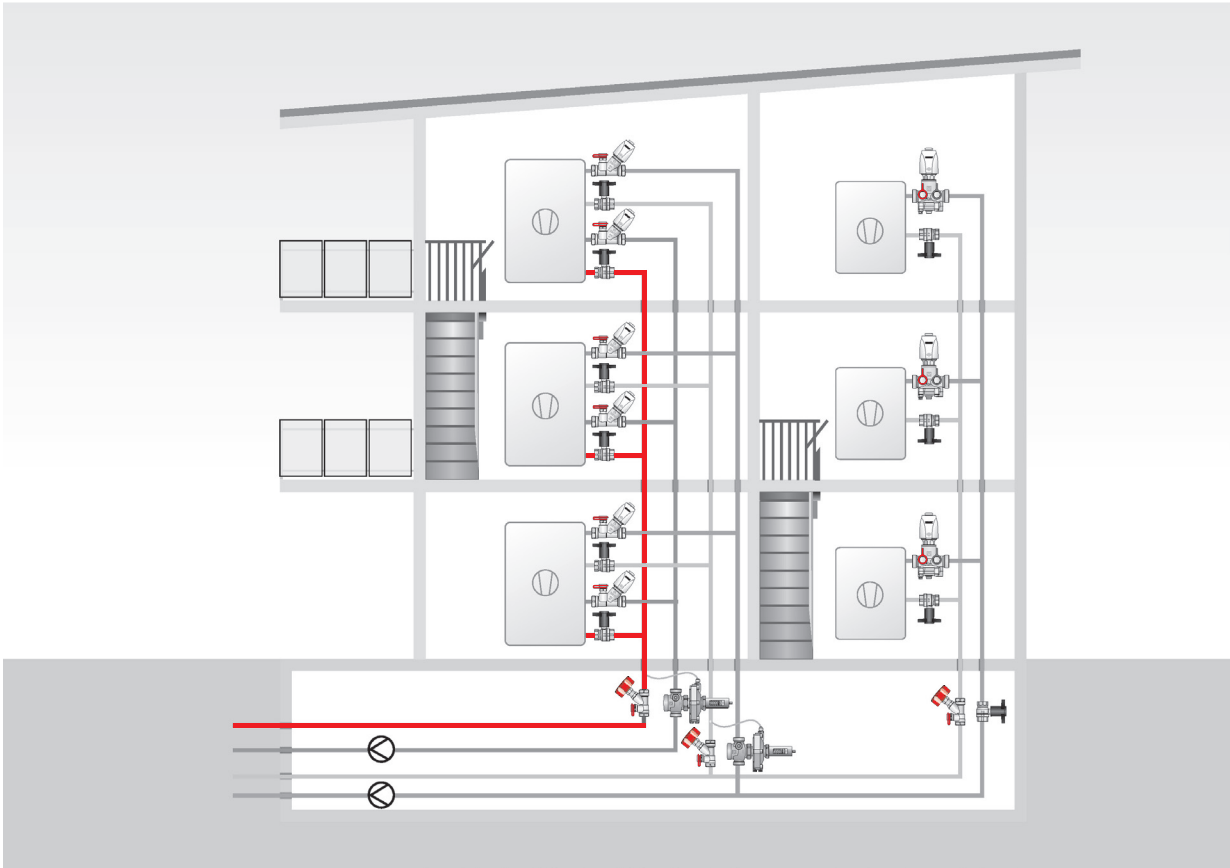

All specifications and statements within this document are according to information available at the time of printing and meant for informational purpose only. Herz Armaturen reserves the right to modify and change products as well as its technical specifications and/or its functioning according to technological progress and requirements. It is understood that all images of Herz products are symbolic representations and therefore may visually differ from the actual product. Colours may differ due to printing technology used. In case of any further questions don't hesitate to contact your closest HERZ Branch-office.

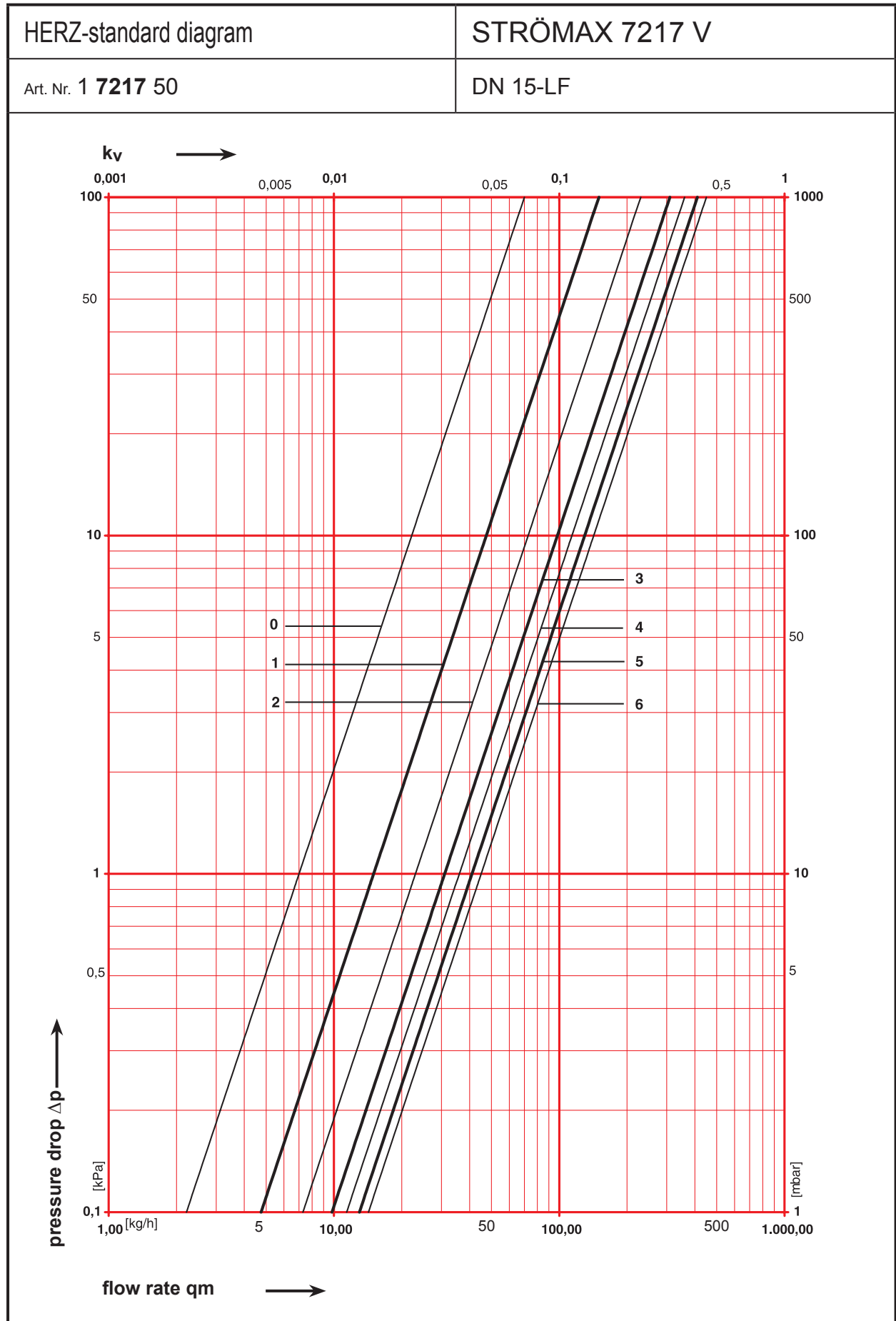

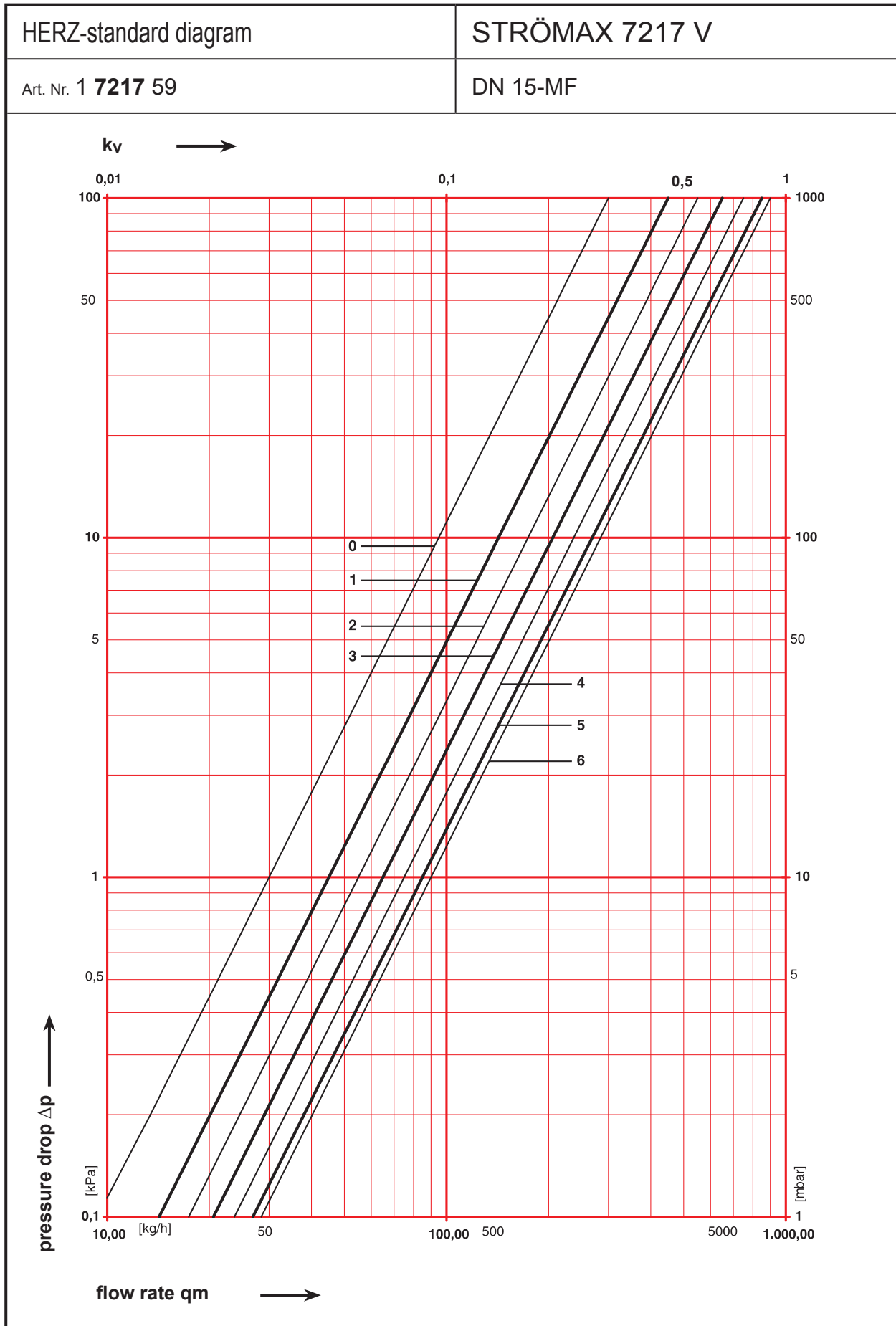

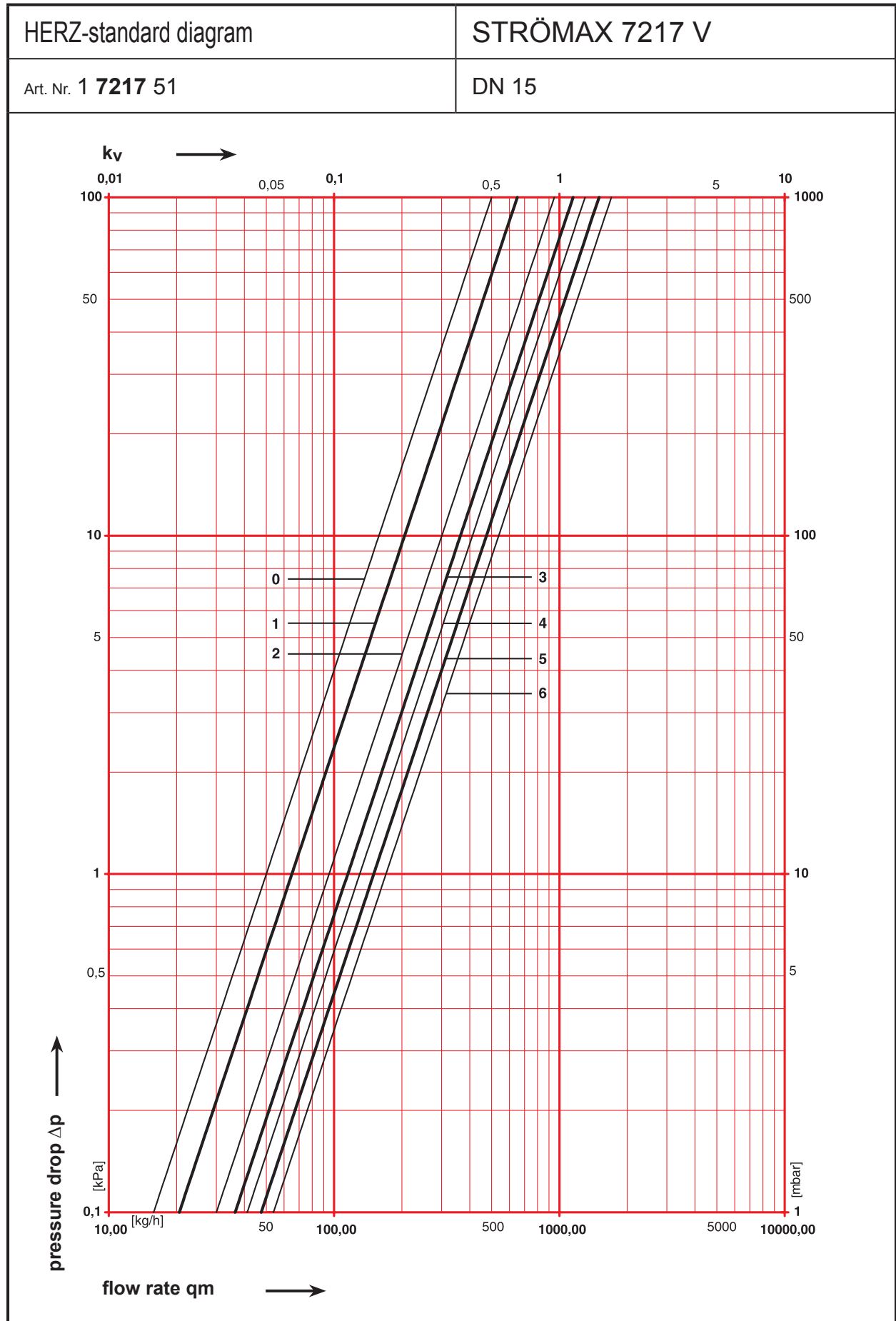

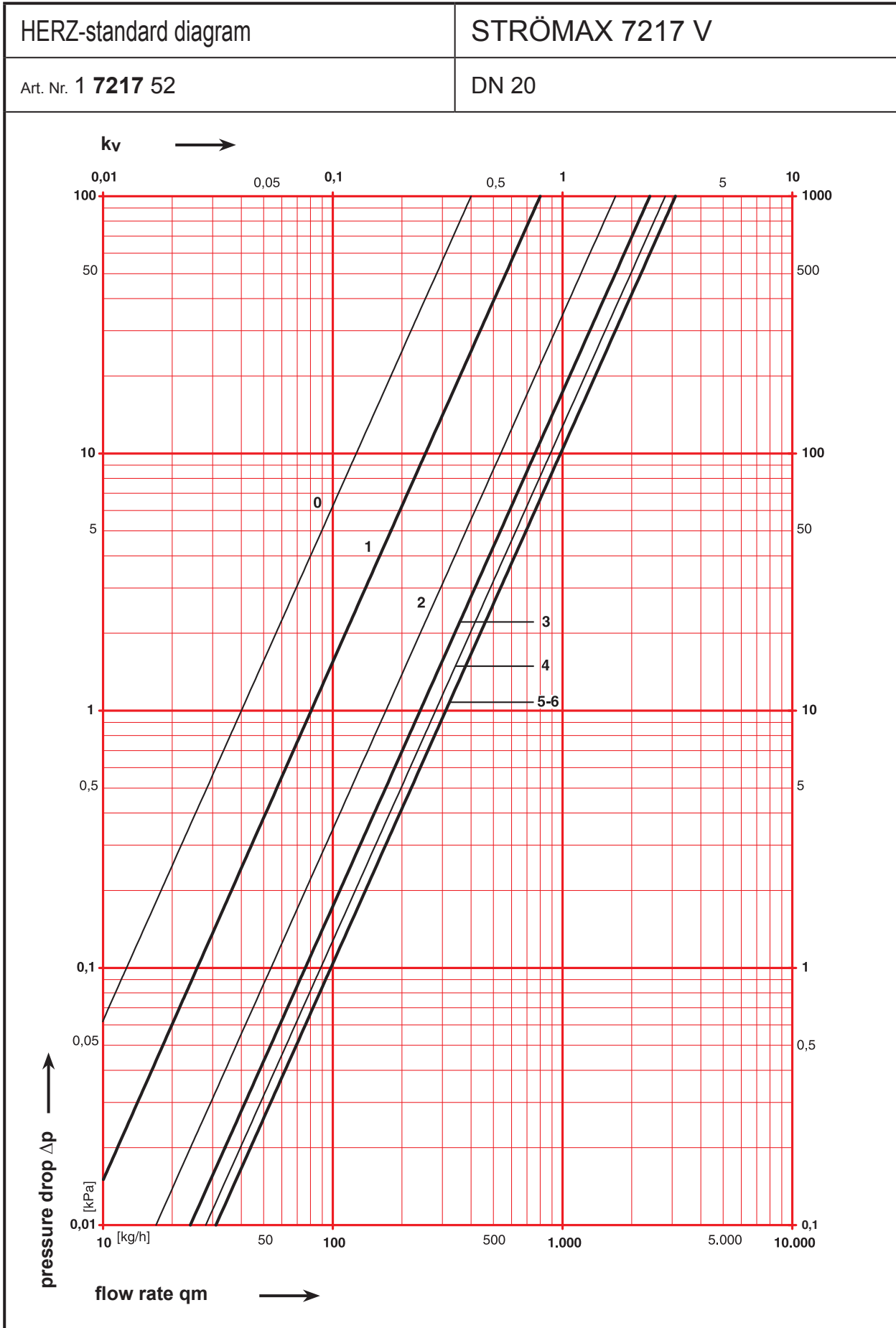

HERZ-standard diagram	STRÖMAX 7217 V
Fig. No. 1 7217 50	Dim. DN 15-LF

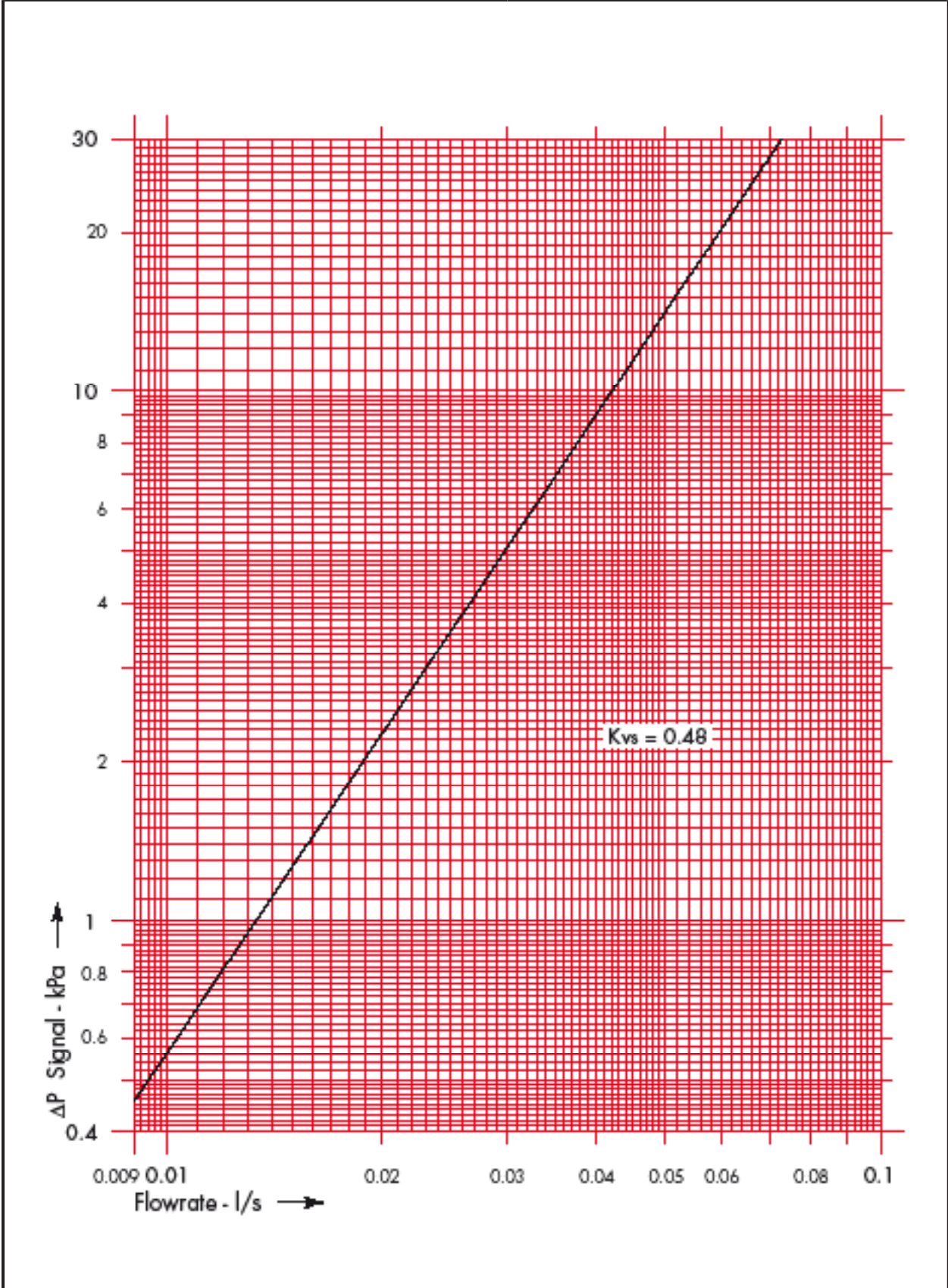

HERZ-standard diagram	STRÖMAX 7217 V
Fig. No. 1 7217 59	Dim. DN 15-MF

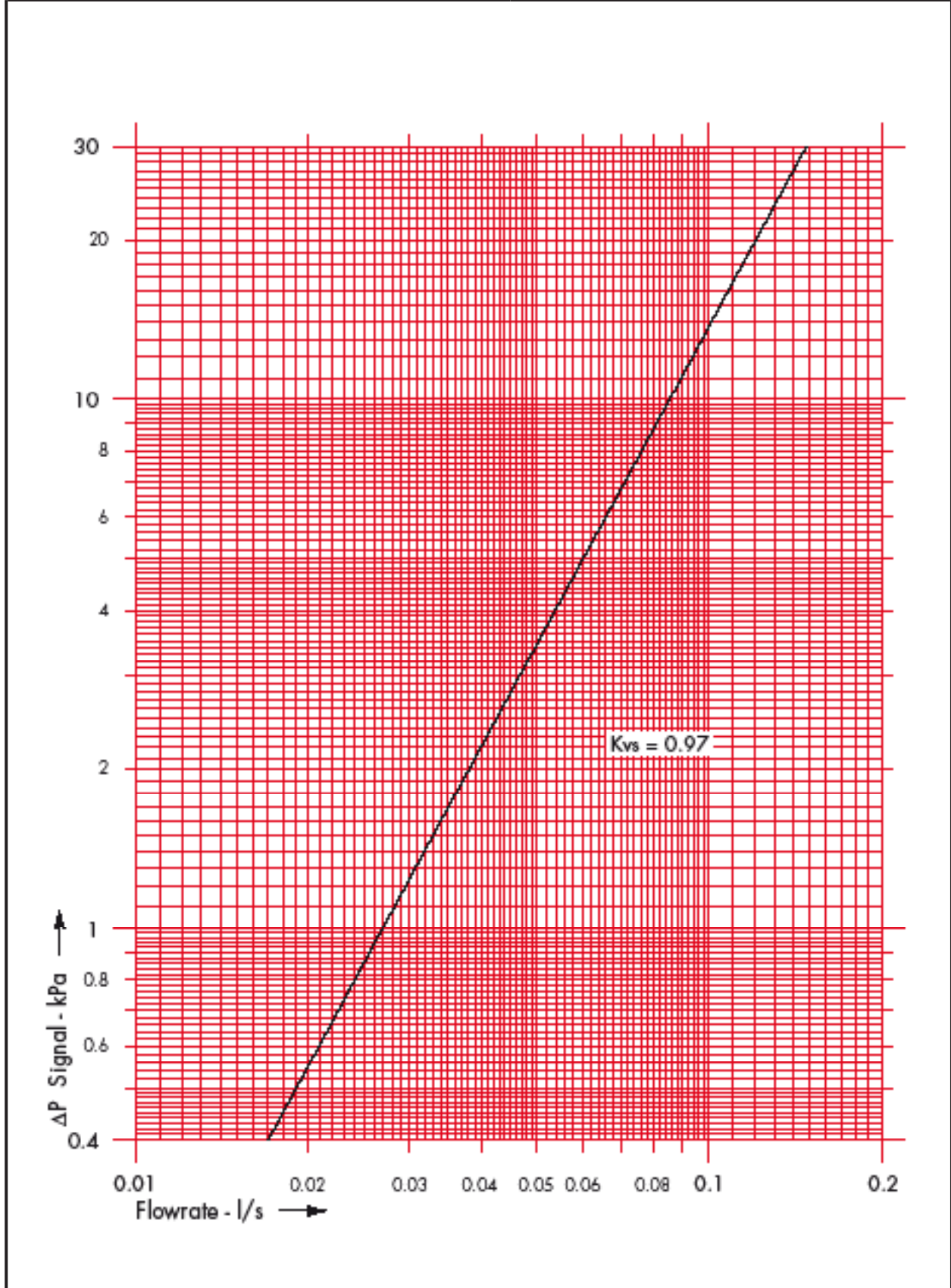

HERZ-standard diagram	STRÖMAX 7217 V
Fig. No. 1 7217 51	Dim. DN 15

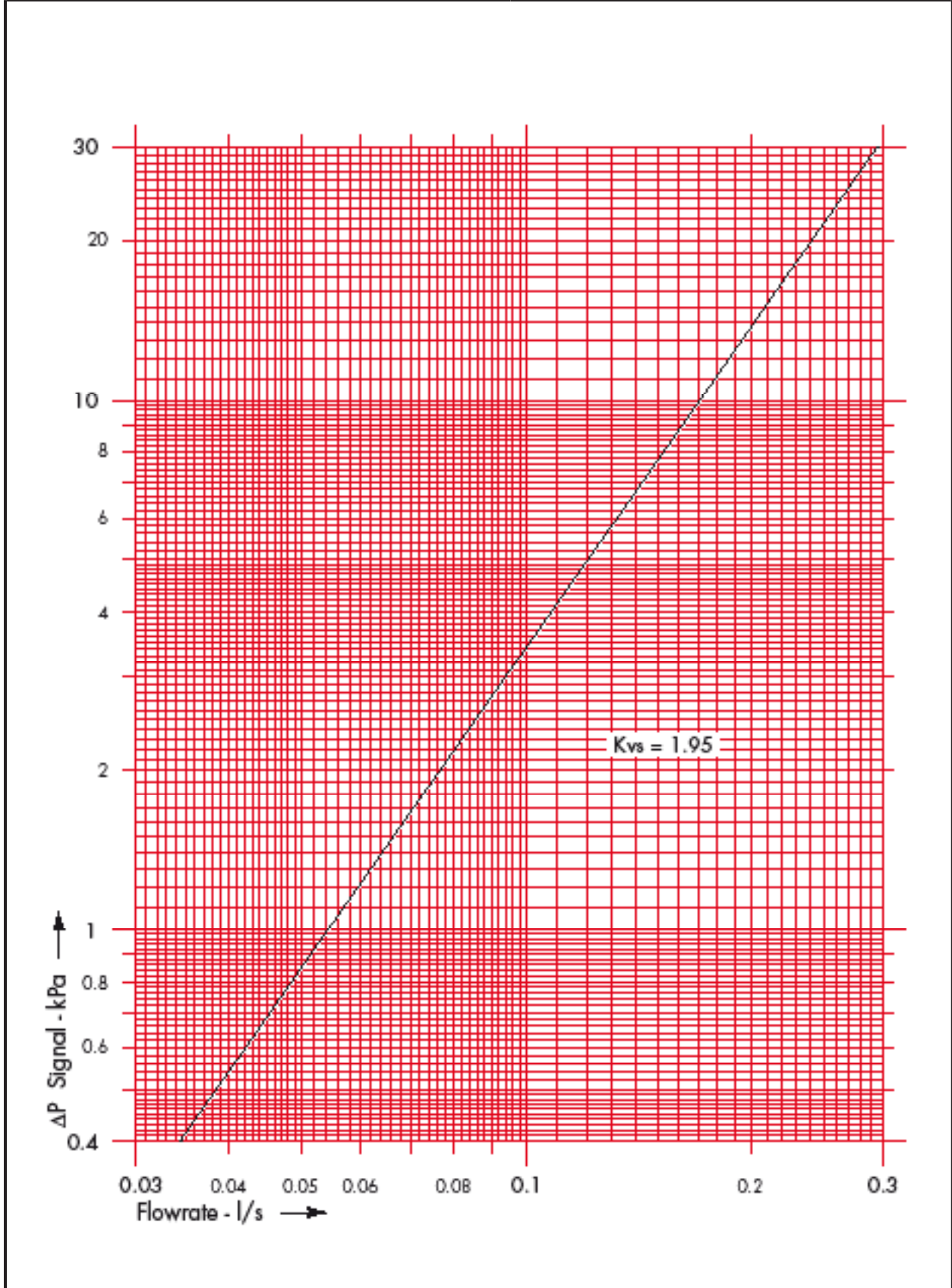

HERZ-standard diagram	STRÖMAX 7217 V
Fig. No. 1 7217 52	Dim. DN 20

