

# HERZ-TS-90

## Thermostatic Valve

Data Sheet for TS-90, Issue 0221



011

EN 215

tested and registered

certificated products:

- 1 7724 90
- 1 7724 91
- 1 7724 92
- 1 7724 95
- 1 7724 96
- 1 7724 97
- 1 7723 90
- 1 7723 91
- 1 7723 92
- 1 7723 95
- 1 7723 96
- 1 7723 97

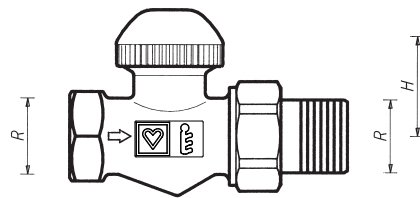

7723

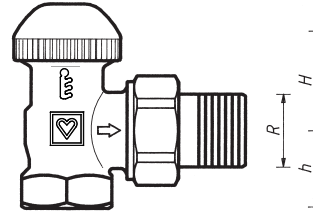

7724

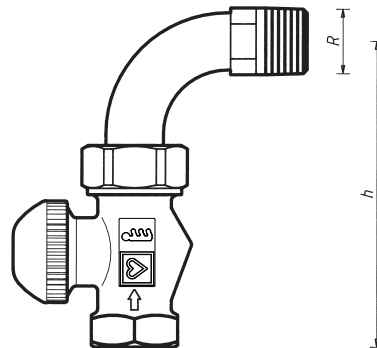

7723 + 6249

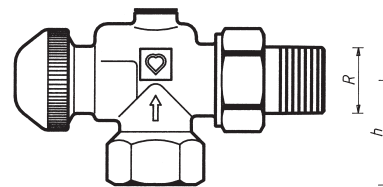

7728

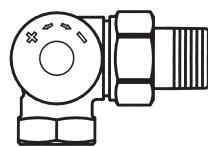

7758

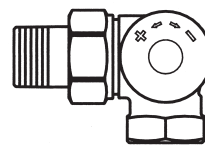

7759

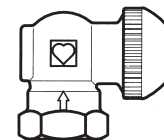

Special models R = R 1/2, G = G 3/4

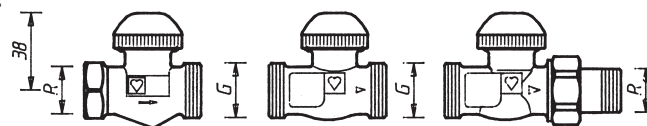

1 7723 61

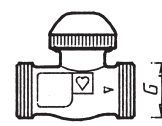

1 7737 91

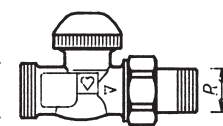

1 7733 81

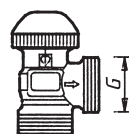

1 7724 41

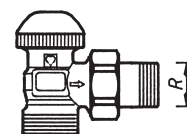

1 7724 37

**☑ Dimensions in mm for Standard Series EN 215 T2, HD 1215**

Art. No.	Designation	DN	R	Ø	L	H	h	Order No.
7723	Dimensional Series "F", Straight Valve	10	3/8	12	75	27	–	1 7723 90
		15	1/2	15	83	27	–	1 7723 91
		20	3/4	18	98	27	–	1 7723 92
7724	Dimensional Series "F", Angle Valve	10	3/8	12	49	27	20	1 7724 90
		15	1/2	15	54	23	23	1 7724 91
		20	3/4	18	63	23	23	1 7724 92
7723	Straight Model "F"	25	1	22	126	27	–	1 7723 93
7724	Angle Model "F"	25	1	22	70	23	33	1 7724 93
7723 + 6249	Dimensional Series "F", Straight Model with elbow	10	3/8	12	40	27	84	Valve and elbow must be ordered separately
		15	1/2	15	54	27	97	
		20	3/4	18	60	27	114	
7728	Reverse Angle Model	10	3/8	12	49	35	27	1 7728 90
		15	1/2	15	55	35	33	1 7728 91
		20	3/4	18	66	32	33	1 7728 97
7758	AB	10	3/8	12	49	26	21	1 7758 90
		15	1/2	15	53	26	31	1 7758 91
7759	CD	10	3/8	12	49	26	21	1 7759 90
		15	1/2	15	53	26	31	1 7759 91
7723 D	Dimensional Series "D", Straight Valve	10	3/8	12	85	27	–	1 7723 95
		15	1/2	15	95	27	–	1 7723 96
		20	3/4	18	106	27	–	1 7723 97
7724 D	Dimensional Series "D", Angle Valve	10	3/8	12	52	27	22	1 7724 95
		15	1/2	15	58	23	26	1 7724 96
		20	3/4	18	66	23	29	1 7724 97
7723 D + 6249	Dimensional Series "D", Straight Model with elbow	10	3/8	12	40	27	94	Valve and elbow must be ordered separately
		15	1/2	15	54	27	107	
		20	3/4	18	60	27	122	

**☑ Models**

All models are nickel plated and supplied with a screw cap.

Universal models with special socket for threaded pipe and compression union:

<b>HERZ-TS-90</b>	<b>7723</b>	<b>3/8 – 3/4</b>	Straight model dimensional series "F"
	<b>7724</b>	<b>3/8 – 3/4</b>	Angle model dimensional series "F"
	<b>7728</b>	<b>3/8 – 3/4</b>	Reverse angle model
<b>HERZ-3-D</b>	<b>7758</b>	<b>1/2</b>	3-axis valve "AB", radiator to the right of the intake valve
	<b>7759</b>	<b>1/2</b>	as above "CD", radiator to the left
<b>HERZ-TS-90</b>	<b>7723 D</b>	<b>3/8 – 3/4</b>	Straight model, Dimensional Series "D"
	<b>7724 D</b>	<b>3/8 – 3/4</b>	Angle model, Dimensional Series "D"

Universal models with threaded socket:

1 7723 93	1	Straight model
1 7724 93	1	Angle model

### ☑ HERZ-TS-90 Special Valve Models

HERZ-TS-90 Special Valve Models, dimension 1/2"

1 7723 61	Straight model, universal socket x male thread G 3/4, with cone seal
1 7737 91	Straight model, 2 x male thread G 3/4, with cone seal
1 7733 81	Straight model, radiator connection with cone seal, pipe connection male thread G 3/4
1 7724 41	Angle model, 2 x male thread G 3/4, with cone seal
1 7724 37	Angle model, radiator connection with cone seal, pipe connection male thread G 3/4

### ☑ Other Versions

<b>HERZ-TS-90-E</b>	Valves with reduced resistance for one-pipe systems
<b>HERZ-TS-E</b>	Valves with maximum flow for one-pipe systems
<b>HERZ-TS-90-V</b>	Valves with continuous, concealed pre-setting
<b>HERZ-TS-98-V</b>	Valves with continuous, read-out pre-setting
<b>HERZ-TS-90-kv</b>	Valves with fixed kv-values for district heating systems

Separate standard sheets are available for these models.

### ☑ Operating Data

Maximum operating temperature 120 °C

Maximum operating pressure 10 bar

Heating water purity according to Austrian standard ÖNORM H 5195 and/or VDI-guideline 2035.

Ethylene and propylene glycol can be mixed to a ratio of 25 - 50 vol. %.

When using HERZ compression unions for copper and steel pipes, observe the permissible temperatures and pressures as specified in EN 1254-2:1998 Table 5. A maximum operating temperature of 95 °C and maximum operating pressure of 10 bar applies for plastic pipe connections, if permitted by the pipe manufacturer.

### ☑ Field of Application

Water heating and cooling systems

### ☑ Radiator Connection

Iron pipe connection 6210, with cone seal.

It is recommended that the HERZ assembly key 6680 be used.

### ☑ Further Connecting Options

Order numbers are available in HERZ Product Range Catalogue.

To be used instead of the radiator connection and on the male thread G 3/4:

<b>6210</b>	<b>1/2</b>	Iron pipe connection, lengths 26 mm and 35 mm.
<b>6211</b>	<b>1/2</b>	Reducing connection, 1/2" x 3/8".
<b>6213</b>	<b>3/8</b>	Reducing connection, 3/8 x 1/2".
<b>6218</b>	<b>3/8 – 3/4</b>	Long threaded bush, without nut, can be shortened to compensate for differences in structural dimensions, lengths 3/8" x 40; 1/2" x 76; 3/4" x 70 mm.
<b>6218</b>	<b>1/2</b>	Threaded bush, without nut, lengths 36, 39, 42, 48 and 76 mm.
<b>6235</b>	<b>3/8 – 3/4</b>	Soldering connection 3/8" x 12; 1/2" x 12, 15 and 18; 3/4" x 18.
<b>6249</b>	<b>3/8 – 3/4</b>	Connection elbow for iron pipes, without nut, with cone seal.
<b>6274</b>	<b>G 3/4</b>	Compression union for copper and thin-walled steel pipes, external pipe diameters 8, 10, 12, 14, 15, 16, 18.
<b>6276</b>	<b>G 3/4</b>	HERZ compression union with soft seal for copper and thinwalled steel pipes, particularly suitable for hard special steel pipes and pipes with hard-galvanised surfaces. For external pipe diameters 12, 14, 15, 16 and 18 mm.
<b>6098</b>		HERZ compression union for PE-X-, PB and plastic composite pipes.

For use on the socket side of the valve:

<b>6219</b>	<b>1/2 – 3/4</b>	Reduction socket, brass, for connecting pipe and valve, female thread (pipe) x male thread (valve) 1" x 1/2", 1 1/4" x 1/2", 1 x 3/4", 1 1/4" x 3/4".
<b>6066</b>	<b>M 22 x 1,5</b>	Plastic pipe connection for PE-X-, PB and plastic composite pipes, for use with adapter <b>1627201</b> (G 1/2 x M 22 x 1.5).
<b>6098</b>	<b>G 3/4</b>	Plastic pipe connection for PE-X, PB and plastic composite pipes, for use with adapter <b>1626601</b> (G 1/2 x G 3/4).

For pipe dimensions of plastic pipe connections refer to the HERZ catalogue.

### ☑ Pipe Connecting, Universal Models

The universal models are equipped with special sockets offering the option of connecting either a threaded pipe or calibrated soft-steel or copper pipe, the latter two by means of a compression union. The compression union must be ordered separately.

When using R = 1/2" valves for external pipe diameters of 10, 12, 14, 16 and 18 mm use adapter Art. No. 6272 between valve and the compression union.

Pipe Ø D mm		12	10	12	14	15	16	18	18
Valve	R =	3/8	1/2						3/4
Adapter	Ord. No.	–	1 6272 01	1 6272 01	1 6272 01		1 6272 01	1 6272 11	
Comp. Union	Ord. No.	1 6292 00	1 6284 00	1 6284 01	1 6284 03	1 6292 01	1 6284 05	1 6289 01	1 6292 02

We recommend use of support sleeves for the installation of soft steel or copper pipes with compression unions. For perfect installation, it is imperative to lubricate the thread of the locking nut (male thread and female thread) as well as the olive itself with silicon oil. We refer to our instructions for installation.

### ☑ Special Design Features

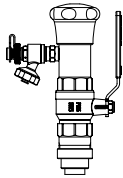

#### Changing the Upper Part of a Thermostat Valve

The upper part of the HERZ thermostatic valve can be changed under pressure by means of the HERZ changing tool for the purpose of:

- Equipping the valve with another thermostatic valve upper part with fixed, stepped kv-values or with pre-adjustable upper part. This allows for adaption of the volume flows through the individual radiators to actual requirements
- Cleaning the seal at the spindle and/or changing the upper part of the valve. These are easy methods of removing defects in radiator thermostat valves, caused e. g. by foreign substances such as dirt, welding and soldering residues.

When using the valve with the new upper part follow the instructions enclosed with the changing tool.

### ☑ Spindle Seal, HERZ-TS-90 O-Ring-Chamber



An O-Ring is used as a spindle seal. It is located in a brass chamber which can be changed during operation. The O-Ring keeps maintenance requirements to a minimum and permits smooth valve operation over a long period of time.

#### Changing the O-Ring

1. Dismantle the HERZ thermostatic head and/or the HERZ-TS-handwheel.
2. Then, the O-Ring chamber, including the O-Ring, is unscrewed and replaced with a new one. During this change, use a wrench to hold the upper part. During dismantling, the valve is completely open and therefore sealed tight. However, a few drops of water may leak out.
3. For re-assembly follow the above steps in reverse sequence. When installing the HERZ-TS handwheel, make sure that the valve closes by turning!

Article number for O-Ring set: 1 6890 00

### ☑ HERZ-Thermostat Valve, Nominal Lift



The screw cap serves for operation during the installation phase (pipe flushing). The thermostatic valve is formed by removing the screw cap and screwing in the HERZ thermostatic head without draining the heating system.

Setting the nominal lift with the screw cap:

On the knurled part of the circumference of the screw cap there are two setting marks (webs in) alignment with the "+" and "-" marks.

1. Close the valve by turning the screw cap clockwise.
2. Mark the position corresponding to the setting mark "+".
3. Turn the screw cap anti-clockwise until the setting mark "-" is at the position marked under item 2.

### ☑ Installation

The lower part of the thermostatic valve is incorporated into the radiator intake with the flow in the installation direction of the arrow (arrow on the valve body). If possible, the HERZ thermostatic head should be in a horizontal position in order to permit optimum room temperature control and minimise interference.

### ☑ Important for Installation

Under no circumstances should the HERZ thermostatic head be exposed to direct sunlight or to the Important for Installation effects of equipment emitting relevant quantities of heat, e. g. TV sets. If the radiator is covered by curtains this will lead to the formation of a heat accumulation zone in which the thermostat cannot sense the room temperature properly and consequently cannot control it. In such cases, use the HERZ thermostat with remote sensor or the HERZ thermostat with remote adjustment.

For detailed information on the HERZ thermostats consult the individual standard sheets.

### ☑ Summer Setting

After the end of the heating period open thermostats or handwheels completely by turning anti- Summer Setting clockwise, this prevents dirt particles accumulating at the valve seat.

### ☑ HERZ-TS Handwheel



In case the lower part of a HERZ thermostatic valve is not equipped with a HERZ thermostatic head the HERZ-TS handwheel will replace the screw cap.

During assembly follow the enclosed instructions.

### ☑ Accessories, Handwheel

- 1 6680 00 HERZ assembly key for connections
- 1 6807 90 HERZ-TS-90 assembly key
- 1 7780 00 HERZ changing tool for thermostat upper parts
- 1 9102 80 HERZ design hand wheel

### ☑ Spare Parts

- 1 6390 9x Thermostatic upper parts, order numbers available in HERZ product range catalogue.
- 1 6890 00 HERZ-TS-90 O-ring set

### ☑ Proportional band

p-difference [K]	kv-value							
	0,5	1	1,5	2	2,5	3	3,5	4
TS 90 DN10	0,13	0,27	0,39	0,51	0,59	0,63	0,66	0,68
TS 90 DN15	0,15	0,31	0,46	0,60	0,75	0,81	0,82	0,83
TS 90 DN20	0,20	0,39	0,56	0,70	0,83	0,95	1,05	1,12
TS 90 DN25	0,23	0,45	0,68	0,90	1,11	1,32	1,51	1,72

### ☑ Material

HERZ uses top-quality brass that responds to the latest European norms EN 12164 and EN 12165.

Pursuant to Article 33 of the REACH Regulation (EC No. 1907/2006), we are obliged to point out that the material lead is listed on the SVHC list and that all brass components manufactured in our products exceed 0.1% (w / w) lead (CAS: 7439-92-1 / EINECS: 231-100-4). Since lead is a component part of an alloy, actual exposure is not possible and therefore no additional information on safe use is necessary.

**☑ Manufacturer information**

Order number thermostatic valve	Order number thermostatic head	Nominal flow rate Valve DN10 l/h	Nominal flow rate Valve DN15 l/h	Nominal flow rate Valve DN20 l/h
	1 7230 06	165	190	220
	1 7260 06	165	190	220
	1 7260 16	165	190	220
1 7724 90	1 7060 16	165	190	220
1 7724 91	1 7060 26	165	213	220
1 7724 92				
1 7724 95	1 9200 30	165	190	220
1 7724 96	1 9200 60	165	190	220
1 7724 97				
1 7723 90	1 9220 03	165	190	220
1 7723 91	1 9220 06	165	190	220
1 7723 92	1 9240 03	165	190	220
1 7723 95				
1 7723 96	1 9240 06	165	190	220
1 7723 97	1 9230 06	165	213	220
	1 9260 06	165	213	220
	1 9260 98	165	213	220
	1 9860 10	165	213	220

When using different thread types for HERZ thermostatic valves and HERZ thermostatic heads, suitable adapters have to be used.

**☑ Disposal**

Disposal must comply with local and current legislation. Prior to the assembly, maintenance and disassembly, the system must be depressurized, cooled down and emptied. Only authorized, trained and qualified personnel may perform activities of assembly, start-up, operation and disassembly of the equipment. Before disposal the valve must be dismantled into groups of structural components and delivered to authorized waste recycling organizations in order to preserve the environment. Local legislations must be obeyed when disposing of the components.

**Please note:** All specifications and statements within this document are according to information available at the time of printing and meant for informational purpose only. Herz Armaturen reserves the right to modify and change products as well as its technical specifications and/or its functioning according to technological progress and requirements. It is understood that all images of Herz products are symbolic representations and therefore may visually differ from the actual product. Colours may differ due to printing technology used. In case of any further questions don't hesitate to contact your closest HERZ Branch-office.

