

HERZ stainless steel distributor

Dimension DN25

Datasheet 1 863X XX, Issue 0522

Table of contents

- General information2
- Function principle of components.....4
- Dimensions and components 1 8631 XX6
- Dimensions and components 1 8632 XX7
- Dimensions and components 1 8633 XX8
- Dimensions and components 1 8634 03 - 1 8634 12.....9
- Dimensions and components 1 8634 13 - 1 8634 22.....10
- Dimensions and components 1 8635 52 - 1 8635 53.....11
- HERZ standard diagrams..... 13
- Spare parts..... 16
- Example of system with HERZ products.....18

HERZ stainless steel distributor

General information

☑ Description of HERZ - Distributors for floor heating systems

HERZ - Distributors for floor heating systems are high quality products that are assembled and pressure tested during the manufacturing process under constant quality control.

Advantages of HERZ - Distributors for floor heating systems are:

- all integrated components are the result of our own development
- possibility of high pressure, high or low temperature and high flow of medium
- easy to use and maintain
- reliable design and long service life
- permanent quality control of production in our own factories
- easy installation
- possibility from 3 to 12 heating circuits
- compatibility with other HERZ products
- air vent and drain valve integrated
- flow meters 3 l/min and 6 l/min

☑ Field of application

HERZ - Distributors are used in floor heating systems, wall heating systems or ceiling heating. When using a version with flow meter the individual heating circuits can be regulated. An adjustment of the flow volume is also possible by the shut-off valves. The distribution bars are each closed on one side with a plug. Distributor input is female threaded G1" so it is possible to connect distributor with threaded pipes or with an adapter for HERZ PIPEFIX. We recommend to use HERZ shut-off valves or HERZ ball valves.

☑ Assembly instruction

The HERZ - Distributors for floor heating systems can be mounted using the supplied brackets distribution directly to a wall or in a distributor cabinet. The mounting position is arbitrary. Distributor with flow meter must always be used in the supply flow. The factory setting is fully open and be adjusted by using the supplied adjusting key turned clockwise. The set amount of flow volume can be read directly at the inspection glass. HERZ-Cabinets must be ordered separately, see separate data sheet, product code 1 8569 XX

☑ Maintenance instruction

No mineral oil lubricant may be used for the maintenance of valves. Usage of these materials will damage sealing elements. Silicone-based lubricant are allowed. To avoid sticking of thermostatic valves monthly operating is recommended.

☑ Disposal instruction

The disposal of HERZ - Distributors for floor heating systems must not endanger the health or the environment. National legal regulations for proper disposal of the HERZ - Distributors for floor heating systems have to be followed.

Models:

1 8631 XX	Supply flow distributor rod G1" with shut-off valves Return flow distributor rod G1" with thermostatic valves
1 8632 XX	Supply flow distributor rod G1" with flowmeter 0 – 3 l/min Return flow distributor rod G1" with thermostatic valves
1 8633 XX	Supply flow distributor rod G1" with flowmeter 0 – 6 l/min Return flow distributor rod G1" with thermostatic valves
1 8634 03 - 12	Supply flow distributor rod G1" with shut-off valves Return flow distributor rod G1" with shut-off valves
1 8634 13 - 22	Supply flow distributor rod G1" without valves Return flow distributor rod G1" without valves

 Material and construction

Rod distributor:	Stainless steel X5, CrNi 1810
Shut-off valves:	Brass, EN 12164
Thermostatic valves:	Brass, EN 12164
Sealings:	EPDM
Caps:	Plastic PP
Springs:	Stainless steel X7, CrNiAl 17 7
Internal threaded side connection:	G 1" acc. to ISO 228-1
External threaded bottom connection:	G 3/4" acc. to ISO 228-1, cone sealing

Pursuant to Article 33 of the REACH Regulation (EC No. 1907/2006), we are obliged to point out that the material lead is listed on the SVHC list and that all brass components manufactured in our products exceed 0.1% (w / w) lead (CAS: 7439-92-1 / EINECS: 231-100-4). Since lead is a component part of an alloy, actual exposure is not possible and therefore no additional information on safe use is necessary.

 Operating data

Max. operating pressure without flowmeter	10 bar
Max. operating pressure with flowmeter	6 bar
Test pressure with flowmeter	10 bar at t = 20 °C
Max. operating temperature without flowmeter	110 °C
Max. operating temperature with Flowmeter	70 °C
Min. operating temperature	2 °C

Medium:

Heating water quality according to ÖNORM H5195 or VDI-Standard 2035. The use of ethylene or propylene glycol in a mixing ratio 25- 50% is allowed. Please refer to manufacturers documentation when using ethylene glycol products for frost and corrosion protection. Please note that EPDM gaskets will be affected by Mineral oils lubricants and thus lead to failure of the EPDM seals in the valves that use EPDM seals. The HERZ - Distributors for floor heating systems is not suitable for usage of aggressive medium (such as: acids, alkalis, combustible and explosive gases.) because it can destroy sealing components.

The actually permissible operating data depends on the pipes or clamp connections used.

Example: if plastic pipe connections are used the bottom operation data is allowed (if approved by pipe manufacturer).

Max. operating temperature	70 °C
Max. operating pressure	6 bar

Higher operating pressure is permitted only after written approval by HERZ. When using HERZ compression unions for copper and steel pipes, the permissible temperature and pressure ratings according to EN 1254-2:1998

☑ Function principle of components

• Flowmeter valves

The factory setting is fully open. The set amount of flow volume can be read directly at the inspection glass. To adjust the flow volume use plastic adjustment key on top of the knurl and rotate clockwise or counter-clockwise.

Conversion table [l/min] --> [l/h]

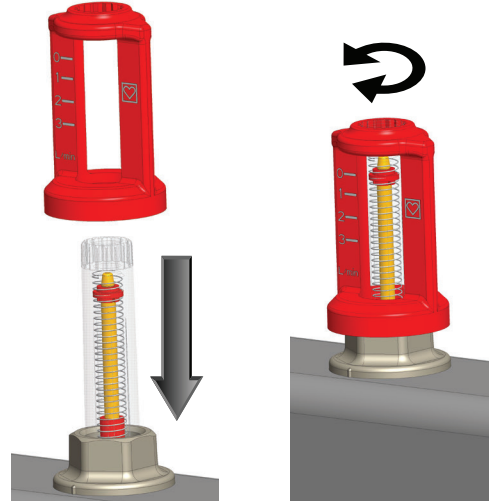
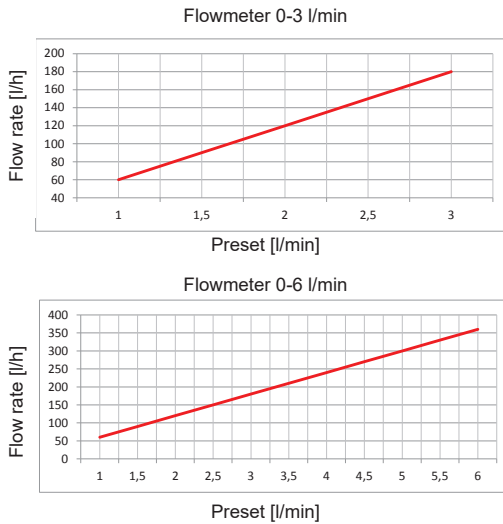

Drain valves

Direction of the distributor flow is evident from the handle color on the drain valves (red: supply / blue: return). On the supply and return rod, a drain valve with connection thread G3/4" is provided on some variants. A hose connection 1 6206 01 can be used additionally. The handwheel is operated by hand to open (rotate counter-clockwise) and close (rotate clockwise) the drain valve. The valve is used for filling and emptying. After use, close the valve. Under no circumstances should the valve be permanently open and integrated in the distribution system.

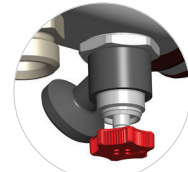

↺ Open
↻ Close

Shut-off valves

The shut-off valves are actuated with an allen wrench size 5mm. Close the valve turning the wrench clockwise until it stops. Open the valve with rotating wrench counter-clockwise.

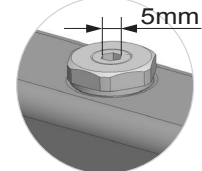

↺ Open
↻ Close

Thermostatic valves M28x1,5

Are opened by spring force and can be closed with protective cap, manual drive or thermal actuator. Protective caps are mounted on the thermostatic valves as mechanical protection during construction. These are to be replaced after commissioning by suitable electrical or mechanical drives. The thermostatic upper parts can be equipped with a manual drive 1 9102 80 or thermal actuators, these must be ordered separately. Thermal actuators are available in 24V or 230V, NC (normally closed) or NO (normally open) available. The thermal drives can be operated by means of room temperature control or radio control. Room temperature control or wireless control are described in separate data sheets, product code see accessoires.

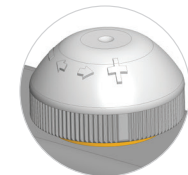

↺ Open
↻ Close

Note !

Thermostatic valves and flowmeters are not shut-off devices. Unfilled heating circuits must be closed with a cap at the outlet.

Airvent valves

On the supply and return rod, an air valve is mounted in each case. The valves can be operated with the HERZ-universal key (1 6625 00).

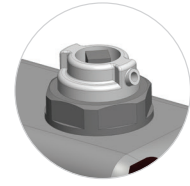

Brackets

The HERZ rod distributors can be mounted using the supplied brackets distribution directly to a wall or in a distributor cabinet. The mounting position is arbitrary.



HERZ stainless steel distributor

shut-off valves / thermostatic valves

Datasheet 1 8631 XX

☑ Dimensions and components

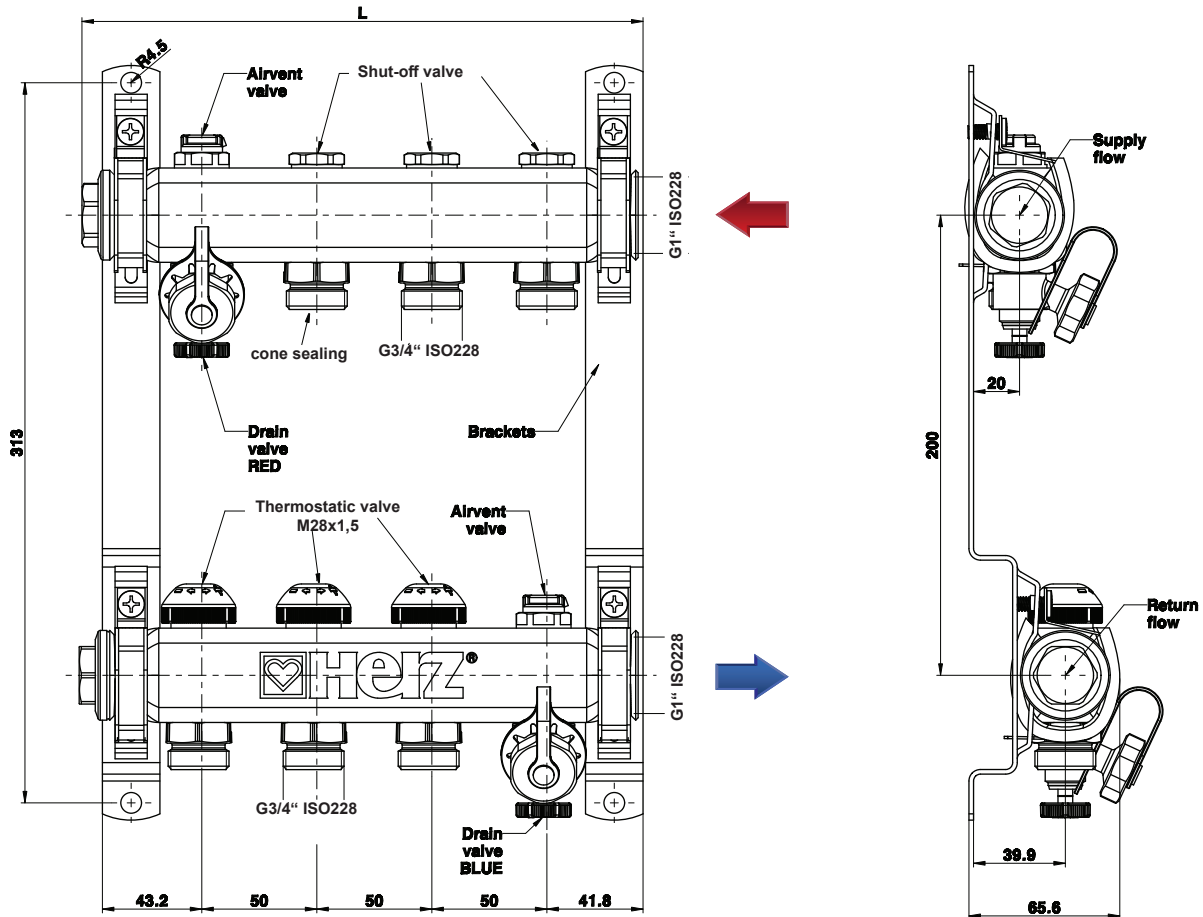

Order Nr.	Outlets	L [mm]	Distributor cabinet **	Distributor cabinet with ball valve straight model	Distributor cabinet with ball valve angle model
1 8631 03*	3	244	1 8569 03	1 8569 05	1 8569 04
1 8631 04	4	294			1 8569 05
1 8631 05	5	343	1 8569 04	1 8569 10	1 8569 10
1 8631 06	6	393	1 8569 05		
1 8631 07	7	443	1 8569 10	1 8569 15	1 8569 15
1 8631 08	8	493			
1 8631 09	9	543	1 8569 15	1 8569 20	1 8569 20
1 8631 10	10	593			
1 8631 11	11	643	1 8569 20	1 8569 25	1 8569 25
1 8631 12	12	693			

*1 8631 03 is shown on the drawing above.

**Minimum size for distributor cabinet. By using shut-off valves the size of distributor cabinet has to be dimensioned larger.

HERZ stainless steel distributor

flow meter 3 L/min / thermostatic valves

Datasheet 1 8632 XX

Dimensions and components

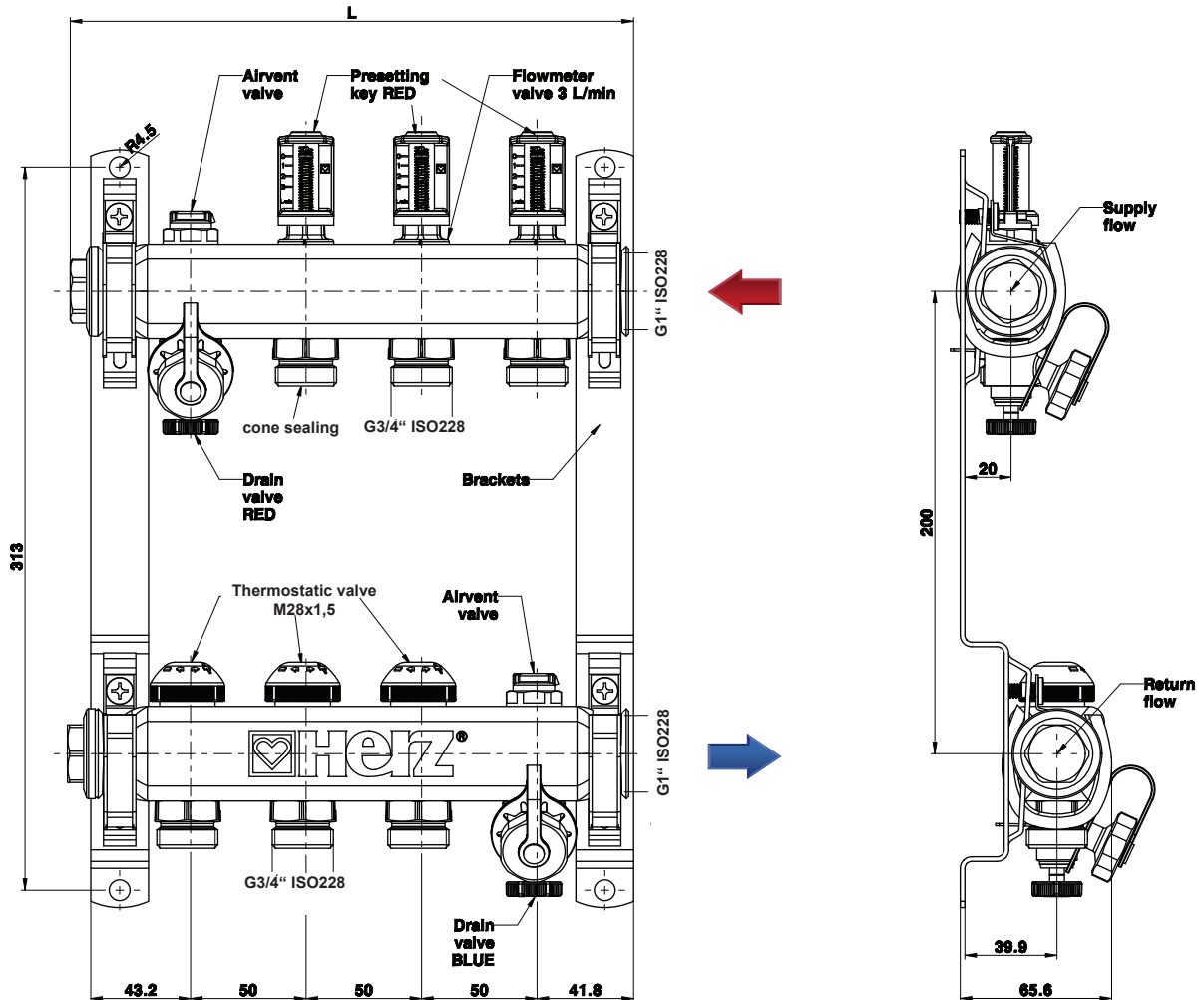

Order Nr.	Outlets	L [mm]	Distributor cabinet **	Distributor cabinet with ball valve straight model	Distributor cabinet with ball valve angle model
1 8632 03*	3	244	1 8569 03	1 8569 05	1 8569 04
1 8632 04	4	294			1 8569 05
1 8632 05	5	343	1 8569 04	1 8569 10	1 8569 10
1 8632 06	6	393	1 8569 05	1 8569 15	1 8569 15
1 8632 07	7	443	1 8569 10		
1 8632 08	8	493	1 8569 10		
1 8632 09	9	543	1 8569 15	1 8569 20	1 8569 20
1 8632 10	10	593			
1 8632 11	11	643			
1 8632 12	12	693	1 8569 20	1 8569 25	1 8569 25

*1 8632 03 is shown on the drawing above.

**Minimum size for distributor cabinet. By using shut-off valves the size of distributor cabinet has to be dimensioned larger.

HERZ stainless steel distributor

flow meter 6 L/min / thermostatic valves

Datasheet 1 8633 XX

☑ Dimensions and components

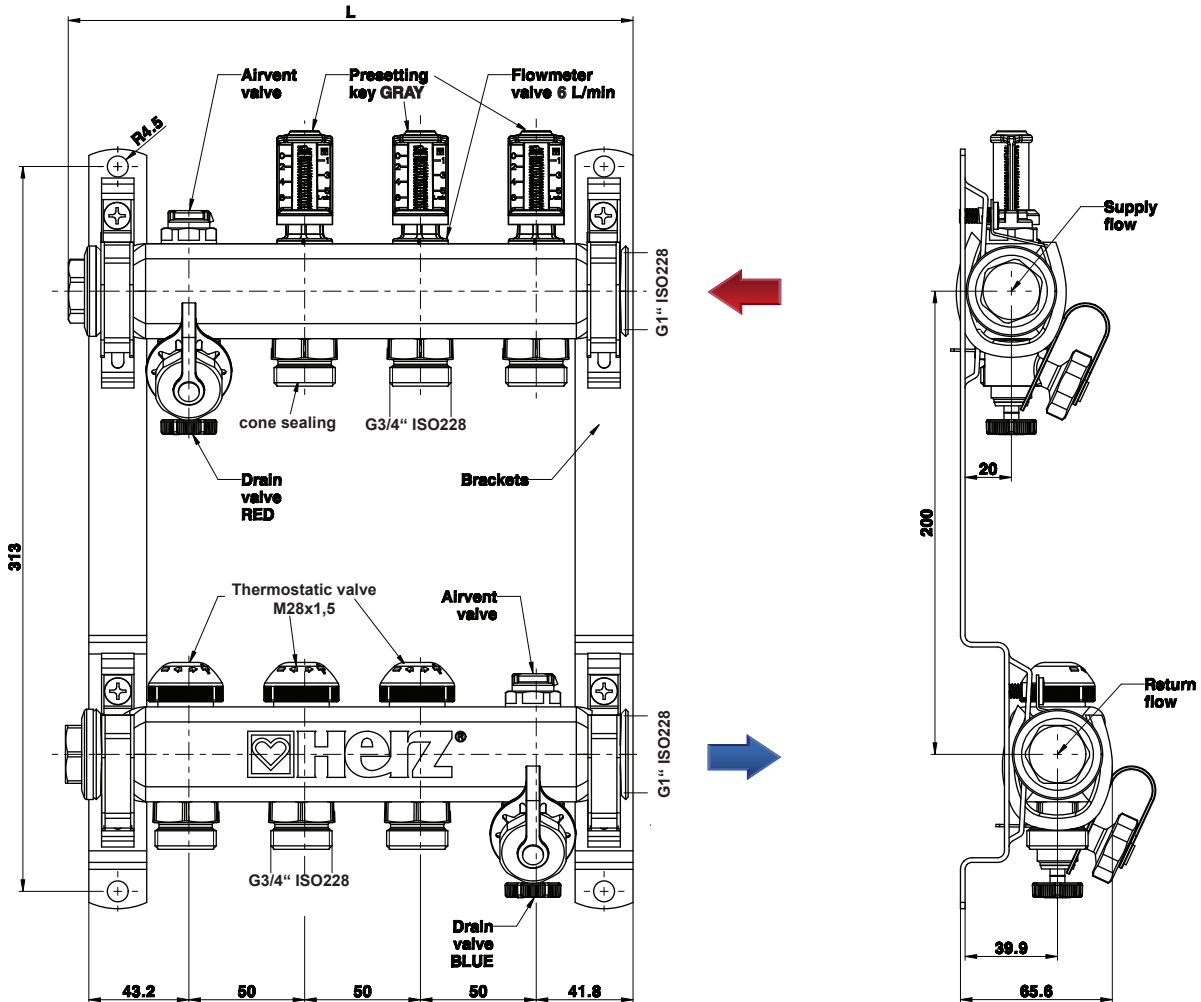

Order Nr.	Outlets	L [mm]	Distributor cabinet **	Distributor cabinet with ball valve straight model	Distributor cabinet with ball valve angle model
1 8633 03*	3	244	1 8569 03	1 8569 05	1 8569 04
1 8633 04	4	294			1 8569 05
1 8633 05	5	343	1 8569 04	1 8569 10	1 8569 10
1 8633 06	6	393	1 8569 05	1 8569 15	1 8569 15
1 8633 07	7	443	1 8569 10		
1 8633 08	8	493	1 8569 15	1 8569 20	1 8569 20
1 8633 09	9	543			
1 8633 10	10	593			
1 8633 11	11	643	1 8569 20	1 8569 25	1 8569 25
1 8633 12	12	693			

*1 8633 03 is shown on the drawing above.

**Minimum size for distributor cabinet. By using shut-off valves the size of distributor cabinet has to be dimensioned larger.

HERZ stainless steel distributor shut-off valves / shut-off valves

Datasheet 1 8634 03 - 1 8634 12

Dimensions and components

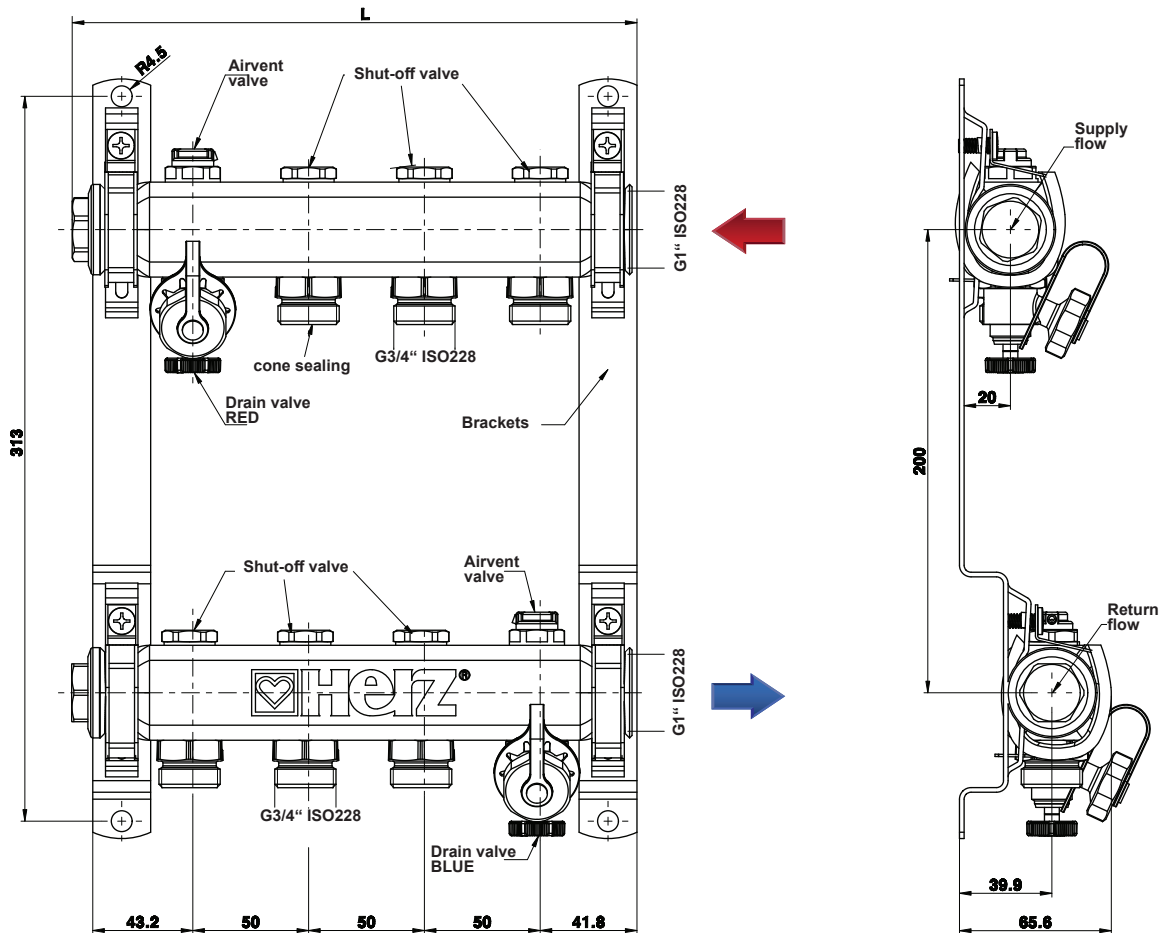

Order Nr.	Outlets	L [mm]	Distributor cabinet **	Distributor cabinet with ball valve straight model	Distributor cabinet with ball valve angle model
1 8634 03*	3	244	1 8569 03	1 8569 05	1 8569 04
1 8634 04	4	294			1 8569 05
1 8634 05	5	343	1 8569 04	1 8569 10	1 8569 10
1 8634 06	6	393	1 8569 05	1 8569 15	1 8569 15
1 8634 07	7	443	1 8569 10		
1 8634 08	8	493	1 8569 10		
1 8634 09	9	543	1 8569 15	1 8569 20	1 8569 20
1 8634 10	10	593			
1 8634 11	11	643			
1 8634 12	12	693	1 8569 20	1 8569 25	1 8569 25

*1 8634 03 is shown on the drawing above.

**Minimum size for distributor cabinet. By using shut-off valves the size of distributor cabinet has to be dimensioned larger.

HERZ - Distributors for floor heating systems without valves

Datasheet 1 8634 13 - 1 8634 22

☑ Dimensions and components

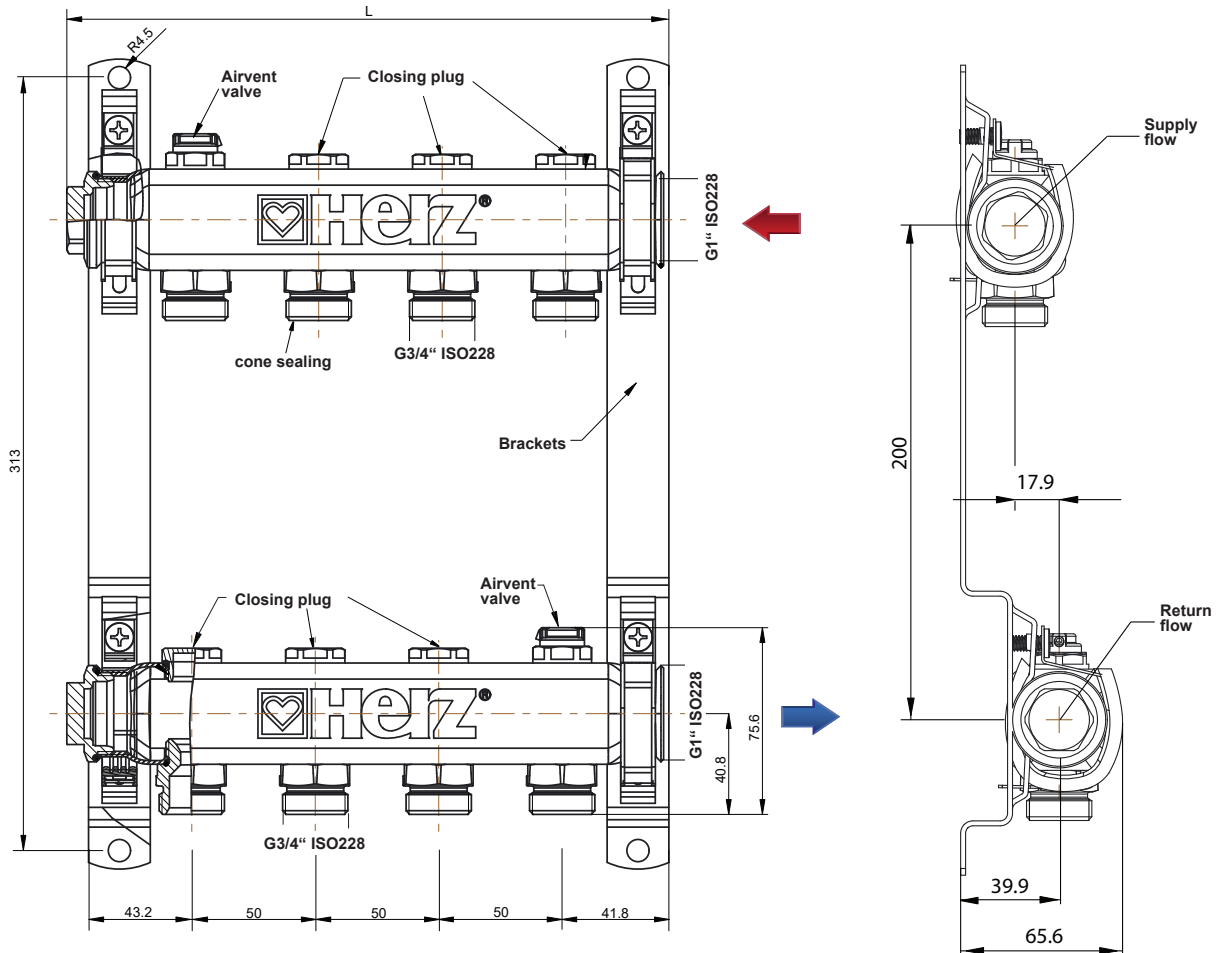

Order Nr.	Outlets	L [mm]	Distributor cabinet **	Distributor cabinet with ball valve straight model	Distributor cabinet with ball valve angle model
1 8634 13	3	194	1 8569 03	1 8569 04	1 8569 03
1 8634 14*	4	244		1 8569 05	1 8569 04
1 8634 15	5	294			1 8569 05
1 8634 16	6	343	1 8569 04	1 8569 10	1 8569 10
1 8634 17	7	393	1 8569 05	1 8569 15	1 8569 15
1 8634 18	8	443	1 8569 10		
1 8634 19	9	493			
1 8634 20	10	543	1 8569 15	1 8569 20	1 8569 20
1 8634 21	11	593			
1 8634 22	12	643			

*1 8634 14 is shown on the drawing above.

**Minimum size for distributor cabinet. By using shut-off valves the size of distributor cabinet has to be dimensioned larger.

HERZ Dynamic Regulation Set for HERZ stainless steel distributor DN25

Data sheet 1 8635 52 - 1 8635 53

☑ Dimensions and components

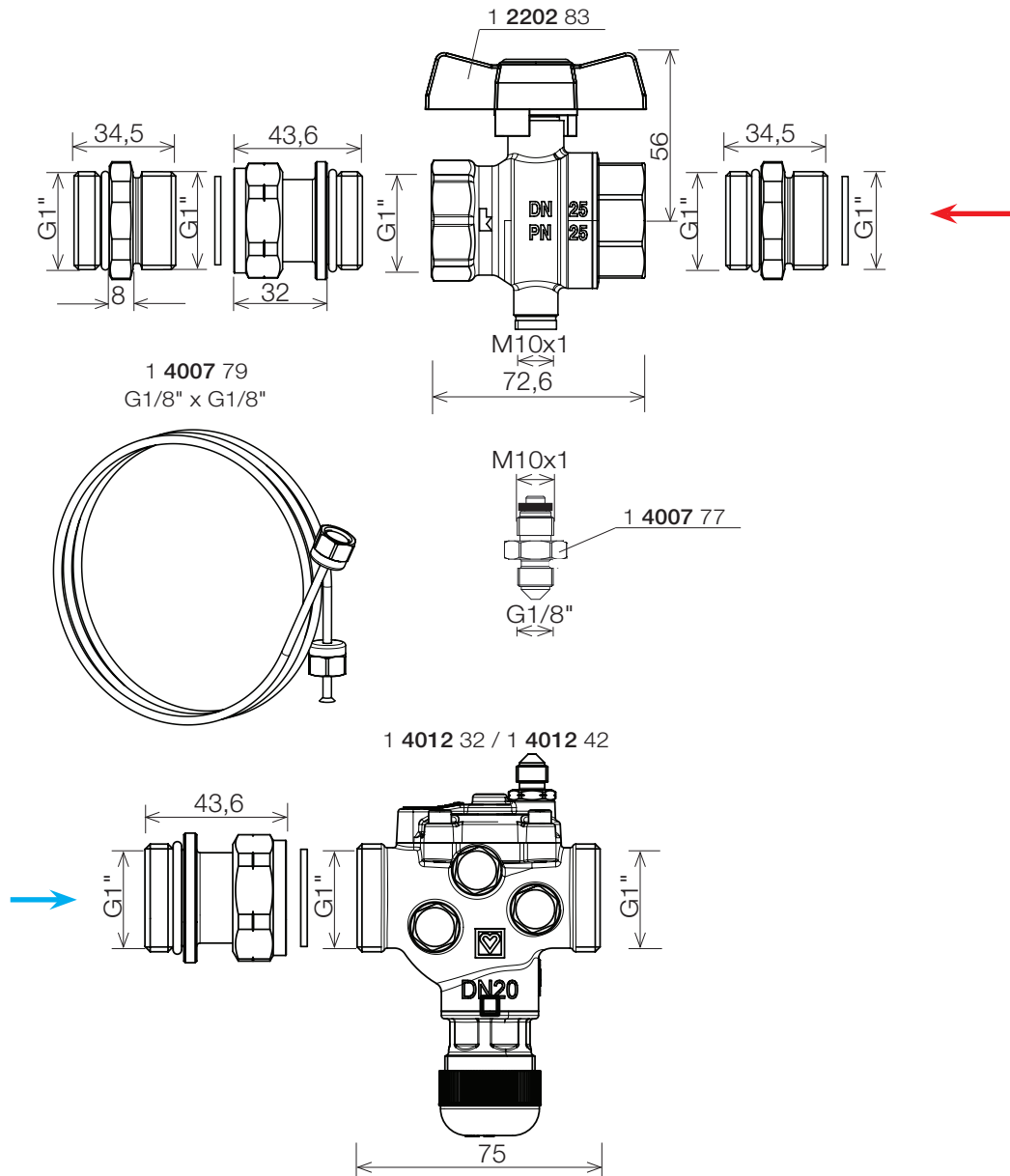

☑ Operating data

Max. operating pressure
Min. operating temperature
Max. operating temperature

PN16 (note the max. pressure in the system)
2 °C
130 °C (note the max. temperature in the system)

☑ Application

HERZ Dynamic Regulation Set was developed for use in hydraulic balancing and for the adjustment and control of heating and cooling circuits. With changing hydraulic operations, the differential pressure at the distributor and thus the flow range of each heating circuit is kept constant. The maximum flow range can be adjusted. Zone control can be implemented with the mounting of an actuator. HERZ Dynamic Regulation Set 1 **8635** 52/53 can be connected directly to the HERZ stainless steel distributor DN25. HERZ stainless steel distributor DN25 with HERZ Dynamic Regulation Set can be used for underfloor, wall and ceiling heating and cooling systems and in combination with radiators.

☑ Medium

Heating water quality according to ÖNORM H5195 or VDI-Standard 2035. The use of ethylene or propylene glycol in a mixing ratio 25- 50% is allowed. Please refer to manufacturers documentation when using ethylene glycol products for frost and corrosion protection. Please note that EPDM gaskets will be affected by Mineral oils lubricants and thus lead to failure of the EPDM seals in the valves that use EPDM seals. The HERZ - Distributors for floor heating systems is not suitable for usage of aggressive medium (such as: acids, alkalis, combustible and explosive gases.) because it can destroy sealing components.

☑ Brass

Pursuant to Article 33 of the REACH Regulation (EC No. 1907/2006), we are obliged to point out that the material lead is listed on the SVHC list and that all brass components manufactured in our products exceed 0.1% (w / w) lead (CAS: 7439-92-1 / EINECS: 231-100-4). Since lead is a component part of an alloy, actual exposure is not possible and therefore no additional information on safe use is necessary.

☑ Assembly instruction

The Dynamic Regulation Set is suitable for direct connection to HERZ stainless steel distributor. The differential pressure control valve **4012** is installed in the return flow of the stainless steel distributor with a connection G 1", O-ring sealing. The direction of flow is indicated by an arrow on the body of the differential pressure controller. The impulse line 1 **4007** 79 is installed using an M10xG1/8" nipple 1 **4007** 77 (included in the delivery) between the differential pressure control valve **4012** and the ball valve 1 **2202** 83 in the flow. The ball valve is connected to the HERZ stainless steel distributor with an adapter G1" flat seal x G1" O-ring seal. The assembly must be carried out with the appropriate tools suitable for the union nut of a connection, adapter and ball valve (Sw).

☑ Maintenance instruction

According to EN 806-5 (point 6. Operation) valves should always be in their fully opened or closed position and actuated at regular intervals to ensure they remain operational. Therefore HERZ Ball valves should be closed and opened periodically (at least twice a year, every 6 months). This prevents the ball valve from blocking, reduces sediment deposition and reduces the possibility of corrosion inside the valve.

☑ Pre-setting

The valve setting is clearly shown in percent.

The differential pressure control valve **4012** is preset or shut off with the HERZ adjustment key (1 **4006** 02)

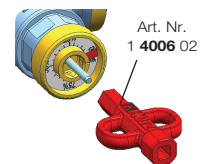

HERZ Table			Q _{max} - max. flow range with negligible resistance in the circuit *)		
1 8635 52 / 1 4012 32 (DN 20 LP) 1 8635 53 / 1 4012 42 (DN 20 HP)					
Pre-setting	DN 20 LP [l/h]	DN 20 HP [l/h]	Pre-setting	DN 20 LP [l/h]	DN 20 LP [l/h]
10%	450	550	55%	1290	1725
15%	650	750	60%	1340	1800
20%	800	950	65%	1380	1850
25%	870	1150	70%	1430	1900
30%	930	1300	75%	1520	1950
35%	1020	1400	80%	1600	2000
40%	1100	1500	85%	1650	2050
45%	1150	1575	90%	1700	2100
50%	1200	1650	95%	1750	2125
*) additional resistance in the circuit reduces Q _{max}			100%	1800	2150

☑ Note on actuators

Actuating drives 1 **7708** 5X, 1 **7990** 31, 1 **7711** 10, 1 **7711** 12 or a geared motors 1 **7708** 4X can be installed for zone control.

HERZ-Standard diagram

Heating circuit outlet with shut-off valve

Order #: 8631, 8634

Shut-off valves 3 – 12 Outlets

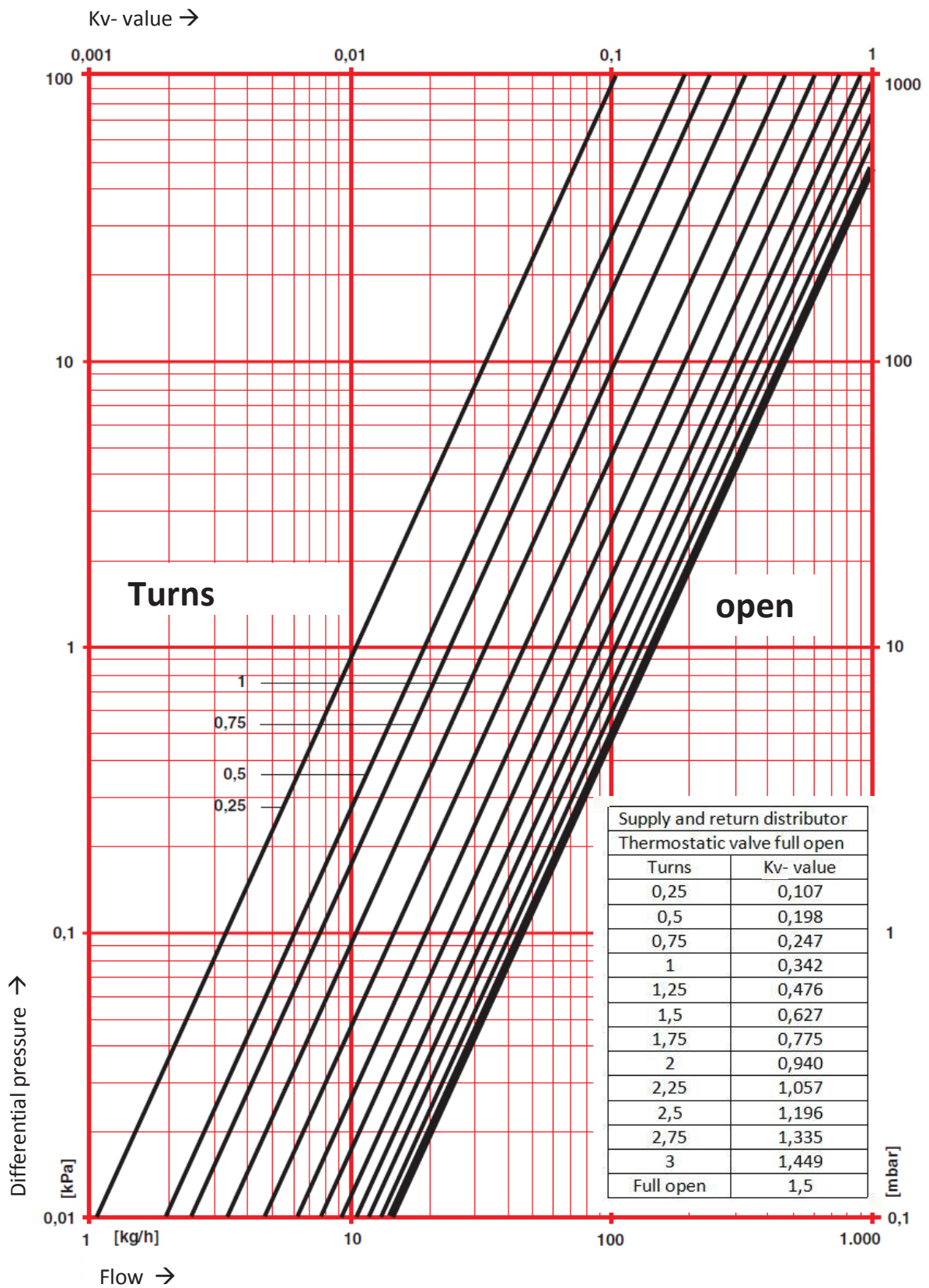

HERZ-Standard diagramm

Heating circuit outlet with
thermostatic valve

Order #: 8631, 8632, 8633

TS-Valves 3 – 12 Outlets

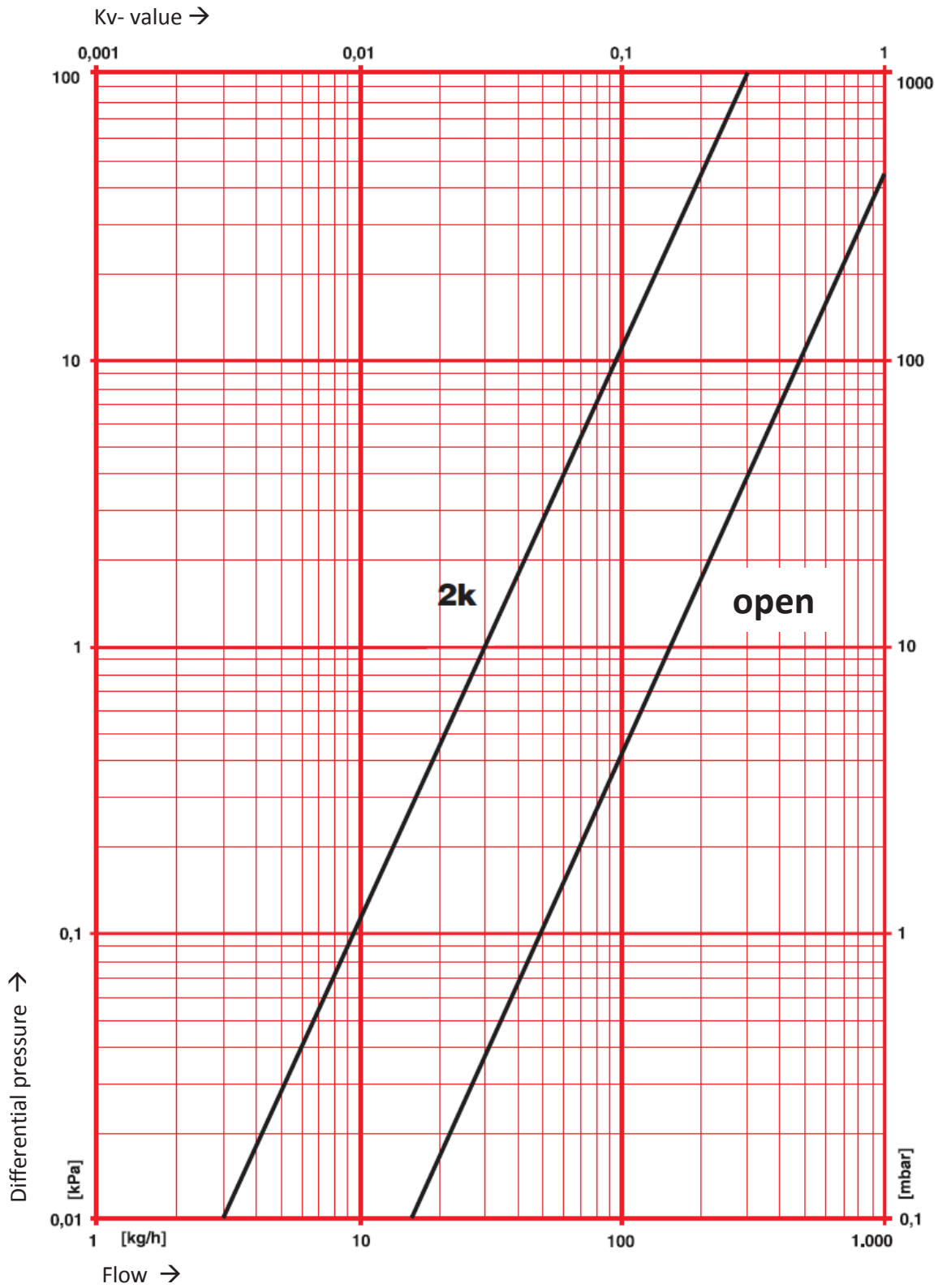

HERZ-Standard diagram

Heating circuit outlet with flow meter

Order #: 8632, 8633



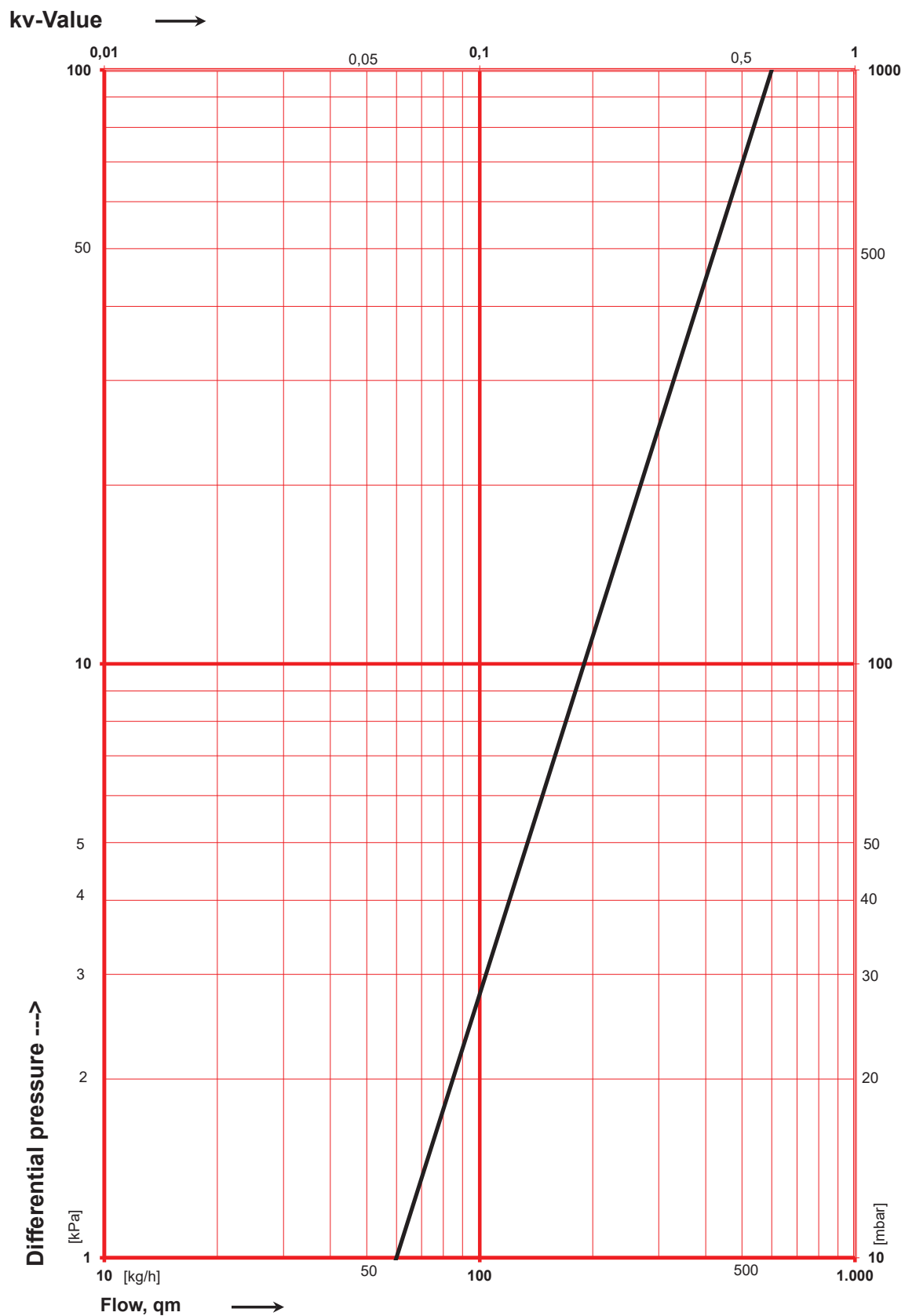

Flowmeter

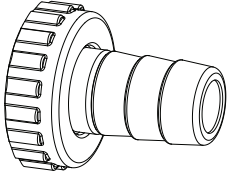
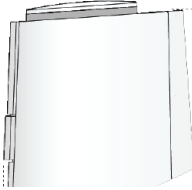
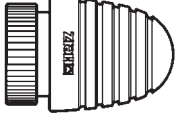
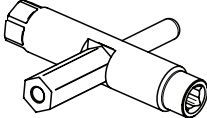
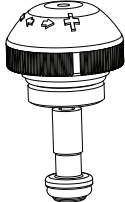
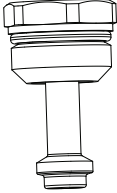
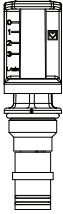

HERZ stainless steel distributor

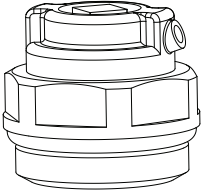
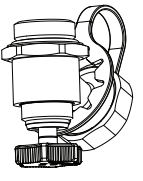
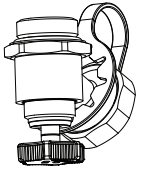
SPARE PARTS and ACCESSORIES

Illustration	Description	Item number	Suitable with
	Hose connection	1 6206 01	1 8631 XX 1 8632 XX 1 8633 XX 1 8634 XX
	Thermal Actuator 24V NC	1 7708 52	1 8631 XX 1 8632 XX 1 8633 XX
	Thermal Actuator 230V NC	1 7708 53	1 8631 XX 1 8632 XX 1 8633 XX
	Manual Drive	1 9102 80	1 8631 XX 1 8632 XX 1 8633 XX
	Universal key	1 6625 00	1 8631 XX 1 8632 XX 1 8633 XX 1 8634 XX
	Upper thermostatic insert	1 6403 31	1 8631 XX 1 8632 XX 1 8633 XX
	Upper shutoff insert	1 4020 59	1 8631 XX 1 8634 XX
	Flow meter 3 L/min	3 F900 33	1 8632 XX

	<p style="text-align: center;">Flow meter 6 L/min</p>	<p style="text-align: center;">3 F900 36</p>	<p style="text-align: center;">1 8633 XX</p>
	<p style="text-align: center;">Air vent valve</p>	<p style="text-align: center;">1 4020 59</p>	<p style="text-align: center;">1 8631 XX 1 8632 XX 1 8633 XX 1 8634 XX</p>
	<p style="text-align: center;">Drain valve RED</p>	<p style="text-align: center;">1 8635 55</p>	<p style="text-align: center;">1 8631 XX 1 8632 XX 1 8633 XX 1 8634 XX</p>
	<p style="text-align: center;">Drain valve BLUE</p>	<p style="text-align: center;">1 8635 54</p>	<p style="text-align: center;">1 8631 XX 1 8632 XX 1 8633 XX 1 8634 XX</p>
	<p style="text-align: center;">HERZ - MODUL angled ball valve RED, O-ring sealing on the distributor, screw connection to the ball valve</p>	<p style="text-align: center;">1 2224 03</p>	<p style="text-align: center;">1 8631 XX 1 8632 XX 1 8633 XX 1 8634 XX</p>
	<p style="text-align: center;">HERZ - MODUL angled ball valve BLUE, O-ring sealing on the distributor, screw connection to the ball valve</p>	<p style="text-align: center;">1 2224 13</p>	<p style="text-align: center;">1 8631 XX 1 8632 XX 1 8633 XX 1 8634 XX</p>
	<p style="text-align: center;">HERZ - MODUL straight ball valve RED, O-ring sealing on the distributor, screw connection to the ball valve</p>	<p style="text-align: center;">1 2205 13</p>	<p style="text-align: center;">1 8631 XX 1 8632 XX 1 8633 XX 1 8634 XX</p>
	<p style="text-align: center;">HERZ - MODUL straight ball valve BLUE, O-ring sealing on the distributor, screw connection to the ball valve</p>	<p style="text-align: center;">1 2205 23</p>	<p style="text-align: center;">1 8631 XX 1 8632 XX 1 8633 XX 1 8634 XX</p>

