

# HERZ - Diaphragm Pressure Reducing Valve

Data sheet 1 2682 XX, Issue 0325

## ☑ Dimensions in mm

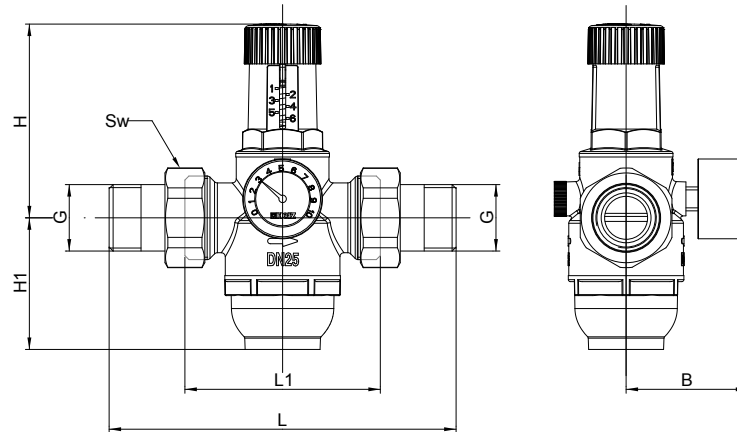

Model	Cap	Dimension	PN	DN	G	L [mm]	L1 [mm]	B [mm]	H [mm]	H1 [mm]	Sw
1 2682 11	plastic	1/2"	16	15	1/2"	147	84	67	98	66	30
1 2682 12	plastic	3/4"	16	20	3/4"	155	84	67	98	66	37
1 2682 13	plastic	1"	16	25	1"	185	98	67	98	66	46
1 2682 14	plastic	1-1/4"	16	32	1-1/4"	204	120	78	156	100	52
1 2682 15	plastic	1-1/2"	16	40	1-1/2"	224	122	78	156	100	60
1 2682 16	plastic	2"	16	50	2"	252	136	78	156	100	75
1 2682 21	brass	1/2"	16	15	1/2"	147	84	67	98	66	30
1 2682 22	brass	3/4"	16	20	3/4"	155	84	67	98	66	37
1 2682 23	brass	1"	16	25	1"	185	98	67	98	66	46
1 2682 24	brass	1-1/4"	16	32	1-1/4"	204	120	78	156	96	52
1 2682 25	brass	1-1/2"	16	40	1-1/2"	224	122	78	156	96	60
1 2682 26	brass	2"	16	50	2"	252	136	78	156	96	75

## ☑ Construction

Body:

(DN 15-25) forged brass acc. to EN 12165

(DN 32-50) casted brass acc. to EN 1982

Upper part:

PA6.6

Diaphragm:

EPDM

Spring:

spring steel

Spring guide:

stainless steel

Sealing:

EPDM

Round handle:

PA 6.6, green

Filter:

stainless steel

Bottom cover:

PA12, transparent (for articles 1 2682 1X)

Bottom cover:

Brass (for articles 1 2682 2X)

Screw connection:

Brass

Sealing screw connection:

Klingsil C-432

## ☑ Specifications

Maximum inlet pressure:

16 bar

Outlet pressure range:

1,5-6 bar

Factory settings:

3 bar

Maximum temperature:

40°C (for articles 1 2682 1X)

Maximum temperature:

70°C (for articles 1 2682 2X)

Manometer scale:

0-10 bar

Mesh perforatio:

0.3 mm

Medium:

water

Standard:

EN 1567

Pressure gauge connectors:

1/4" F (ISO 228-1)

Connectors:

external thread acc. to ISO 7-1 and ISO228



**☑ Assembly**

Before assembling rinse the system well. In potable water installations the pressure reducing valve is mounted behind the water meter. Install the pressure reducer in a horizontal position with the filter facing down. Take care of the flow direction, indicated on the housing. Proper operation requires a straight piece of at least 5x DN pipe before and after the pressure reducer. The attached manometer can be mounted on both sides of the pressure reducer. Before and after the pressure reducer, it is necessary to install an isolating valve. Pressure regulator must be installed without any mechanical tensions in the pipeline, leaving enough space to check manometer and maintenance. In case of installing pressure regulator exposed to UV light or solvent vapours we recommend use brass filter cap. A safety device, such as a safety valve I 0132 X4 or an expansion tank, must always be provided on the pressure-reduced side, as the pressure reducer acts like a backflow preventer and thus creates a closed system after it. Planners and executors have to be advised of the use of a safety device.

**☑ Application and maintenance**

The pressure reducing valve protects drinking water installations against over pressure (reduces input pressure to a working level). The outlet pressure is adjustable and does not vary with changes of the inlet pressure. The outlet pressure can be adjusted by turning the green handle. Turning the handle clockwise increases the outlet pressure. Turning above the stated values on the pressure reducer scale may damage the valve. We recommend the max. outlet pressure of 4 bar for private house installations (product long life, costs,...). After each new setting of the outlet pressure, the regulated pipe has to be opened and closed. We recommend maintenance by authorized installers according to DIN 1988. Check the filter condition in the regulator several times a year and, if it is necessary, clean or replace it with a new one. Tool for maintenance is included in every box of pressure reducer.

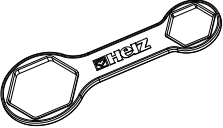
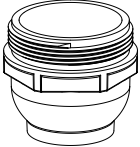
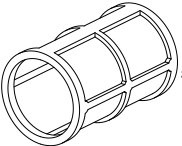
**☑ Spare Parts**

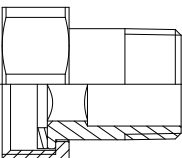
Illustration	Description	Item number
	Tool for maintenance	1 2682 27
	Plastic cover	1 2682 30 (DN15-DN25) 1 2682 31 (DN32-DN50)
	Brass cover	1 2682 32 (DN15-DN25) 1 2682 33 (DN32-DN50)
	Filter	1 2682 28 (DN15-DN25) 1 2682 29 (DN32-DN50)
	Manometer	1 2682 34
	Screw connections, flat seal	1 6221 11 (DN15)
		1 6221 12 (DN20)
		1 6221 13 (DN25)
		1 6221 14 (DN32)
		1 6221 15 (DN40)
		1 6221 16 (DN50)

**Nominal flow rates standard EN 1567**

Size	DN 15	DN 20	DN 25	DN 32	DN 40	DN 50
Flow rate [m <sup>3</sup> /h]	1,27	2,27	3,6	5,8	9,1	14
Flow rate [l/min]	21,16	37,83	60	96,66	151,66	233,33

 **Trouble-shooting**

Problem	Description	Solution
Increased downstream pressure	This problem is due to heating of the water caused by the water heater	- install an expansion tank
Increased downstream pressure	This problem is due to heating of the cold drink water caused by the room temperature	- install a safety valve I <b>0132 X4</b> or an expansion tank
Frozen	Valve exposed to temperatures below 0 °C	- replace valve
Manometer shows a lower pressure under flow conditions than set pressure at no flow	This is normal	- no action
Low flow rate, low downstream pressure	- filter blocked with debris - valve undersized	-clean or change filter cartridge -check valve characteristics and use the right valve

 **Brass**

HERZ uses top-quality brass that is in compliance with the UBA and 4MS lists. HERZ - membrane pressure reducer is made from brass due to its good strength and excellent corrosion resistance. Pursuant to Article 33 of the REACH Regulation (EC No. 1907/2006), we are obliged to point out that the material lead is listed on the SVHC list and that all brass components manufactured in our products exceed 0.1% (w / w) lead (CAS: 7439-92-1 / EINECS: 231-100-4). Since lead is a component part of an alloy, actual exposure is not possible and therefore no additional information on safe use is necessary.

 **Disposal instruction**

The disposal of HERZ - Drinking water manifolds systems must not endanger the health or the environment. National legal regulations for proper disposal of the HERZ - Drinking water manifolds systems have to be followed.

Pressure drop diagram

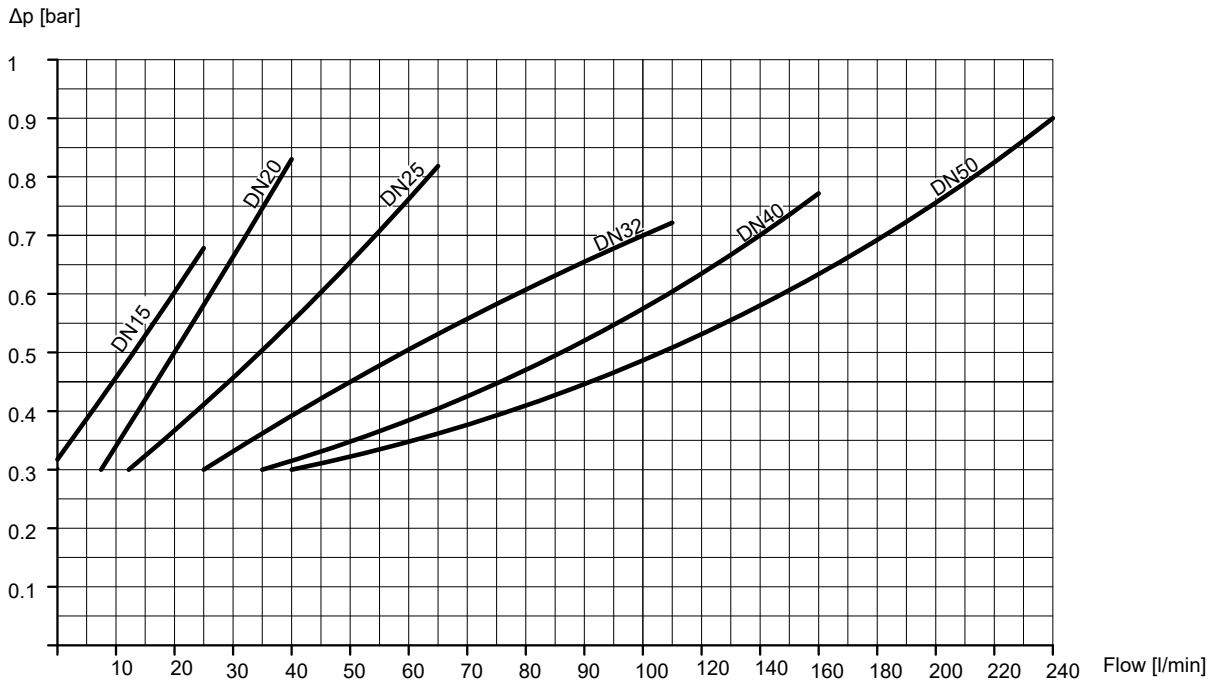

Velocity of water

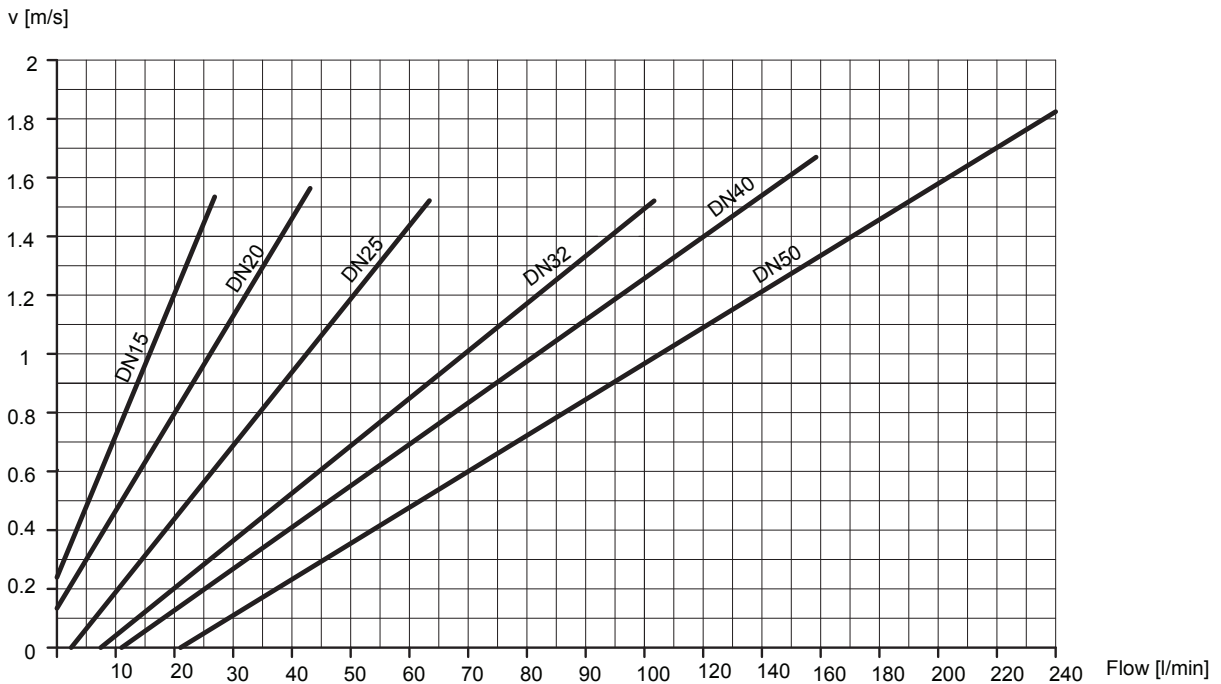

**Please note:** All specifications and information within this document are reflecting the information available at the time of going to print and meant for informational purpose only. Herz Armaturen reserves the right to modify and change products as well as its technical specifications and/or its function according to technological progress and requirements. All diagrams are indicative in nature and do not to be complete. It is understood that all images of Herz products are symbolic representations and therefore may visually differ from the actual product. Colours may differ due to printing technology used. In case of any further questions don't hesitate to contact your closest HERZ Branch-Office.