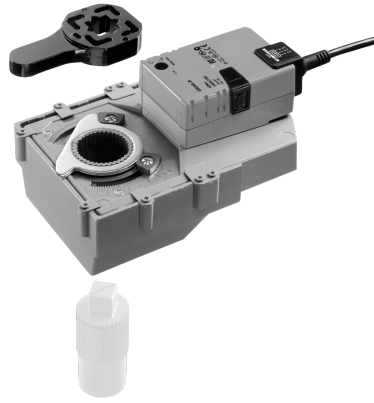

RetroFIT+ rotary actuator for rotary valves and butterfly valves

- Torque motor 40 Nm
- Nominal voltage AC/DC 24 V
- Control Open/close

**Technical data**

<b>Electrical data</b>	Nominal voltage	AC/DC 24 V
	Nominal voltage frequency	50/60 Hz
	Nominal voltage range	AC 19.2...28.8 V / DC 19.2...28.8 V
	Power consumption in operation	4 W
	Power consumption in rest position	2 W
	Power consumption for wire sizing	6 VA
	Connection supply / control	Cable 1 m, 3x 0.75 mm <sup>2</sup>
	Parallel operation	Yes (note the performance data)
<b>Functional data</b>	Torque motor	40 Nm
	Manual override	with push-button, can be locked
	Running time motor	150 s / 90°
	Sound power level, motor	45 dB(A)
	Position indication	Mechanical, integrated
<b>Safety data</b>	Protection class IEC/EN	III, Safety Extra-Low Voltage (SELV)
	Degree of protection IEC/EN	IP54
	Degree of protection NEMA/UL	NEMA 2
	EMC	CE according to 2014/30/EU
	Certification IEC/EN	IEC/EN 60730-1 and IEC/EN 60730-2-14
	Type of action	Type 1
	Rated impulse voltage supply / control	0.8 kV
	Pollution degree	3
	Ambient humidity	Max. 95% RH, non-condensing
	Ambient temperature	0...50°C [32...122°F]
	Storage temperature	-40...80°C [-40...176°F]
Servicing	maintenance-free	
<b>Mechanical data</b>	Connection flange	F05/F07
<b>Weight</b>	Weight	1.9 kg

**Safety notes**

- This device has been designed for use in stationary heating, ventilation and air-conditioning systems and must not be used outside the specified field of application, especially in aircraft or in any other airborne means of transport.
- Outdoor application: only possible in case that no (sea) water, snow, ice, insulation or aggressive gases interfere directly with the device and that it is ensured that the ambient conditions remain within the thresholds according to the data sheet at any time.
- Only authorised specialists may carry out installation. All applicable legal or institutional installation regulations must be complied with during installation.
- The switch for changing the direction of rotation may only be operated by authorised specialists. The direction of rotation must not in particular be reversed in a frost protection circuit.
- The surface temperature between actuator and fitting may not exceed 50°C.
- The device may only be opened at the manufacturer's site. It does not contain any parts that can be replaced or repaired by the user.
- Cables must not be removed from the device.
- The device contains electrical and electronic components and must not be disposed of as household refuse. All locally valid regulations and requirements must be observed.

**Product features**

**Application** For rotary valves and butterfly valves with the following mechanical specifications:  
 – ISO 5211: F05 or F07 (hole circle diameter on the flange for mounting the fitting)  
 – ISO 5211: quadratic or flat head spindle head geometry

**Tappet shaft** The form fit adapter is not included in the scope of delivery (see «Accessories»).

**1 771 47**



**s = 19 mm**

**Simple direct mounting** Simple direct mounting on the rotary valve or butterfly valve with mounting flange. The mounting orientation in relation to the fitting can be selected in 90° steps.

**Manual override** Manual override with push-button possible (the gear train is disengaged for as long as the button is pressed or remains locked).

**Adjustable angle of rotation** Adjustable angle of rotation with mechanical end stops.

**High functional reliability** The actuator is overload protected, requires no limit switches and automatically stops when the end stop is reached.

**Accessories**

Electrical accessories	Description	Type
	Auxiliary switch 1x SPDT add-on	1 7711 50
	Auxiliary switch 2x SPDT add-on	1 7711 51

## Accessories

Mechanical accessories	Description	Type
	Form fit adapter square 19x19x40 mm (LxWxH)	1 7711 47

## Electrical installation



Supply from isolating transformer.

Parallel connection of other actuators possible. Observe the performance data.

Direction of rotation switch is covered. Factory setting: Direction of rotation Y2.

**Wire colours:**

1 = black

2 = red

3 = white





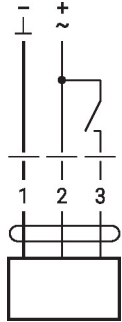



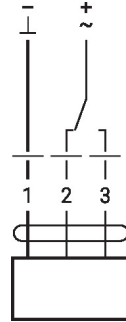

**Wiring diagrams**

AC/DC 24 V, open/close



AC/DC 24 V, open/close (two-wire)



1	2	3	
			
			A - AB = 0%
			A - AB = 100%

## Dimensions

