

Circuit regulating valve STRÖMAX-GMF

Circuit Regulating Valve for Differential Pressure Measurement, flanged version, Srew-down model, with Test Points

data sheet **4218 GMF**, Issue 1114

☑ **4218 GMF** STRÖMAX-GMF with measuring valves and draining option

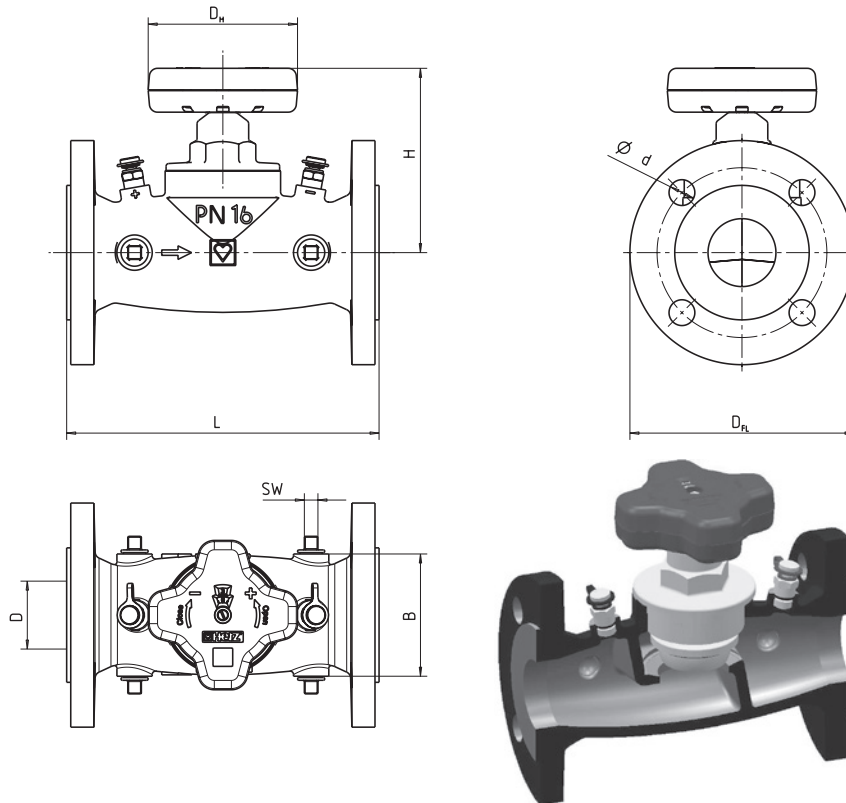

☑ **Dimensions in mm**

Order no. 4218 GMF	DN	L	H	B	DH	DFL	D	d	Hex Square
1 4218 43	25	160	110	58	71	115	25	14	10
1 4218 44	32	180	110	64	71	140	30	19	10
1 4218 45	40	200	110	72	71	150	40	19	10
1 4218 46	50	230	135	90	110	165	50	19	10
1 4218 47	65	290	145	112	110	185	65	19	10
1 4218 48	80	310	145	116	110	200	80	19	10
1 4218 49	100	350	190	158	190	220	100	19	10
1 4218 50	125	400	230	188	190	250	125	19	10
1 4218 51	150	480	264	212	190	285	150	23	10

☑ **Model 4218 GMF**

4218 GMF STRÖMAX-GMF circuit regulating valve with test points DN 25 - 150

Screw-down model, body made of cast iron GJL 250, according to EN 1561, flange according to EN 1092, PN 16, blue coating. Brass upper part, screwed, with non-rising spindle, spindle seal by means of double O-Ring. Pre-setting by limitation of valve lift and inside spindle. Pre-setting step is shown on the digital display in the hand wheel window. Two quick measuring valves are mounted next to hand wheel. Four bores for draining fittings, closed with screw plugs 3/8 (DN10).

Other models

4218 AGF DN 25 - 80	STRÖMAX-AGF shutoff fitting in flanged version, 4 bores for draining option
4007 F DN 25 - 80	differential pressure control, flanged version, 50 to 300 mbar, 4 bores for draining option
4217 GM DN 15 - 80	STRÖMAX-GM circuit regulating valve with test points; screw-down model
4217 GR DN 15 - 80	STRÖMAX-GR circuit regulating valve without measuring valve, screw-down model, female screwed x female screwed
4215 G DN 15 - 80	STRÖMAX-G, shutoff fitting, screw-down model
4215 AG DN 15 - 80	STRÖMAX-GM shutoff fitting, screw-down model with 2 bores for draining option
4007 DN 15 - 80	differential pressure control, 50 x 300 mbar

Measuring valves

Two test points are mounted next to the hand wheel and in the same plane. The valves are pre-sealed. This arrangement guarantees optimum accessibility in every mounting position and optimum installation of measuring devices.

Bore size

Pipe thread 3/8 (DN10).

Draining Fittings

1 **0276 00** draining valve with handle and swivelling hose connection, brass version, hose connection 1 **6206 01** must be ordered separately.

Application

For hydraulic line-up in heating or cooling installations, adjustment and shutoff of distributors, leg, heat exchangers, heating and cooling systems.

Operational data

Max. operating temperature 130°C (up to DN 32), 110 °C (from DN 40)
 Max. operating pressure 16 bar

Ethylene and propylene glycol is to be used in a mixing ratio of 25 - 50 Vol. [%].

Water quality according to ÖNORM H 5195 and VDI 2035

Materials

Valve body cast iron GJL 250 according to EN 1561
 Valve upper part made of brass
 O-Rings EPDM

Constructional characteristics

Flow direction

Ensure that the flow direction is in accordance with the arrow shown on the valve body.

Mounting position

The non-rising valve spindle is mounted vertically to the valve axis and consequently offers optimum accessibility and easy valve handling in every position.

Spindle seal

The spindle seal is equipped with an elastic double O-Ring and it guaranteed to be impermeable and offer easy handling.

Double O-Ring

The double O-Ring seal is maintenance-free and is guarantees a durable and secure sealing of the valve spindle, as well as easy handling of the valve.

Seat seal

The permanently elastic soft seal provides constant temperature. It is corrosion-resistant and allows minor closing pressure.

☑ Measuring of differential pressure

The STRÖMAX-GMF circuit regulating valve is equipped with two test points. Using an appropriate measuring device the differential pressure can be measured. You can also determine the flow quantity dependent on the adjustment level. The appropriate flow quantity is also displayed on the HERZ-8900 and 8903 measuring computers (see operational manual).

☑ Pre-setting

The circuit regulating valve STRÖMAX-GMF is delivered in open position. The pre-setting allows the maximum possible lift. The hand wheel mechanism is set in order to display the digital display value 0,0 when the valve is closed.

☑ Setting and fixing

Pre-setting process

1. Set the valve at the pre-setting required (digital display of hand wheel).
2. Remove fastening screw of hand wheel. Hand wheel may not be pulled off.
3. The pre-setting spindle is now accessible. Screw in blade 3 x 60 until stop.
4. Replace the hand wheel fastening screw again.
5. Install pre-setting seal.
6. Mark the set position on the pre-setting marker and mount it to the valve. Steps 5 and 6 are not necessary but recommended. When using a measuring device for the STRÖMAX-GM valve, it is possible to set a particular flow value without indicating the adjustment value.

The setting can be effected by a differential pressure measurement and the HERZ-setting diagrams. When using a measuring computer please observe the operating instructions of the device.

☑ Digital display Pre-setting

When the valve is closed the pre-setting of the digital display is 0,0. If the complete hand wheel (twist handle, numerical display, mounting base) is removed from the valve or a damaged part has to be renewed, it is recommended re-set the digital display as follows:

1. Mount complete hand wheel and slide it until the hexagonal of the body and the toothed spindle engage.
2. Turn the valve clockwise and close it.
3. If the digital displays shows a value of 0,0 the hand wheel is correctly mounted and can be fastened by a screw. If another value is displayed remove the hand wheel.
4. Twist mounting base and twist handle to set the digital display to 0,0 again. Remount the hand wheel without twisting the spindle.
5. Screw in the fastening screw of the hand wheel.

The valve can now be set the to the requested position.

☑ Test points

Both quick measuring valves 0284 are equipped with a soft seal and are mounted captivated to the circuit regulating valve.

☑ Operation

The HERZ-measuring computer provides appropriate couplings 0284 that guarantee trouble free fastening on the test points.

☑ Dimensions

STRÖMAX-GMF, STRÖMAX-AGF and differential pressure control 4007 F valve bodies are identical, upper parts are identical to GM/GR, G/GA and differential pressure controls are identical to the appropriate female screwed and external thread models.

☑ Accessories

- 1 **6517** 04 Pre-setting seal
- 1 **6517** 05 Pre-setting marker
- 1 **6640** 00 HERZ-universal key
- 1 **8900** 04 HERZ-Measuring computer for one-hand operation
- 1 **0276** 00 Draining valve 3/8 with handle and swivelling hose connection
- 1 **6206** 01 Hose connection
- 1 **0284** 00 Needle for pressure absorption device

☑ Spare Parts

1	0273	00	Screw plug 3/8		
1	0284	01	Quick measuring valve, blue		
1	0284	02	Quick measuring valve, red		
1	6517	06	DN 15 - 40	STRÖMAX-GMF	hand wheel
1	6517	08	DN 50 - 80	STRÖMAX-GMF	hand wheel
1	6517	10	DN 100 - 150	STRÖMAX-GMF	hand wheel
1	6387	12	DN15 - 20	STRÖMAX-GMF	valve upper part, complete
1	6387	13	DN 25	STRÖMAX-GMF	valve upper part, complete
1	6387	14	DN 32	STRÖMAX-GMF	valve upper part, complete
1	6387	15	DN 40	STRÖMAX-GMF	valve upper part, complete
1	6387	16	DN 50	STRÖMAX-GMF	valve upper part, complete
1	6387	17	DN 65	STRÖMAX-GMF	valve upper part, complete
1	6387	18	DN 80	STRÖMAX-GMF	valve upper part, complete

☑ kvs-values

DN	25	32	40	50	65	80	100	125	150
kvs	11,56	16,60	28,60	37,84	60,30	67,80	99,55	186,58	279,05
Position	kv	kv	kv	kv	kv	kv	kv	kv	kv
0,5	0,35	1,15	1,40	2,70	8,36	11,50	0,00	1,58	8,75
1,0	0,75	1,90	2,50	7,80	11,56	15,90	12,35	4,36	17,50
1,5	1,15	2,65	3,60	12,90	14,76	20,30	18,04	10,72	26,08
2,0	1,90	3,40	4,70	18,60	17,80	24,69	23,74	17,08	34,66
2,5	4,10	4,15	5,95	22,60	20,15	27,74	29,84	20,27	38,27
3,0	6,30	4,90	7,20	27,80	22,50	30,60	35,96	23,45	41,88
3,5	7,70	7,35	9,85	29,30	26,55	36,10	42,56	24,93	44,53
4,0	9,10	9,80	12,55	31,60	31,60	41,70	49,20	26,41	47,17
4,5	9,80	12,40	16,05	33,60	38,10	50,70	51,10	28,09	50,34
5,0	10,50	15,00	19,70	35,50	43,90	60,30	53,00	29,77	53,50
5,5	10,55	15,80	21,60	37,15	47,40	62,00	57,50	32,57	57,43
6,0	10,65	16,60	23,50	37,84	51,00	63,78	61,96	35,37	61,36
6,5	10,70		25,15		53,85	65,88	66,86	38,62	66,14
7,0	11,50		26,80		56,70	67,80	71,81	41,87	70,92
7,5	11,53		27,30		58,50		77,11	46,01	76,30
8,0	11,56		27,80		60,30		82,42	50,14	81,68
8,5			28,20				87,77	54,94	87,87
9,0			28,60				93,20	59,74	94,06
9,5							99,55	65,47	100,52
10,0								71,19	106,98
10,5								78,53	114,74
11,0								85,87	122,50
11,5								95,99	132,72
12,0								106,10	142,93
12,5								117,92	155,86
13,0								129,73	168,79
13,5								141,12	181,98
14,0								152,51	195,17
14,5								162,60	207,69
15,0								172,69	220,21
15,5								179,64	233,05
16,0								186,58	245,88
16,5									255,72
17,0									265,56
17,5									272,31
18,0									279,05

Please Note. The following flow and setting values are valid for dimensioning and location of HERZSTRÖMAX-4218 GMF circuit regulating valves.

Measuring

The valves must always be installed with a minimum of 10 pipe diameters of straight pipe, without intrusion, upstream. Downstream of the valve a minimum of 5 pipe diameters of straight pipe are required.

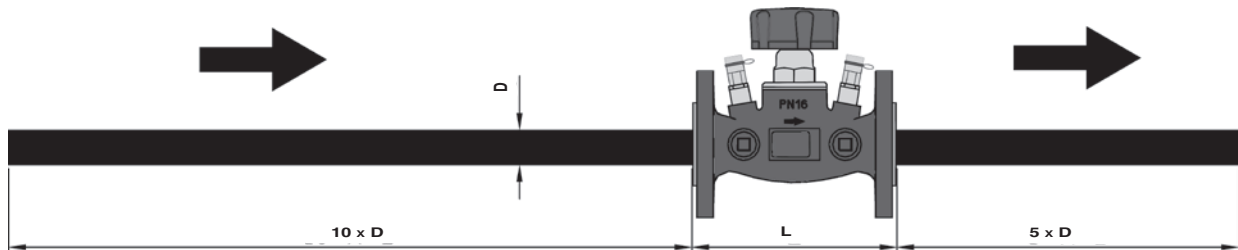

Coating

Base coat based on alkyd resins (resin primer) and contains lead and chromate anticorrosive.

Top coating with epoxy resin.

Solvent content is less than in the VOC plant regulation in 2002 accepted.

Gloss: matt Dry film thickness (DFT): ~ 100 microns

Please note: all diagrams are indicative in nature and do not claim to be complete.

All specifications and statements within this document are according to information available at the time of printing and meant for informational purpose only. Herz Armaturen reserves the right to modify and change products as well as its technical specifications and/or its functioning according to technological progress and requirements. It is understood that all images of Herz products are symbolic representations and therefore may visually differ from the actual product. Colours may differ due to printing technology used. In case of any further questions don't hesitate to contact your closest HERZ Branch-office.

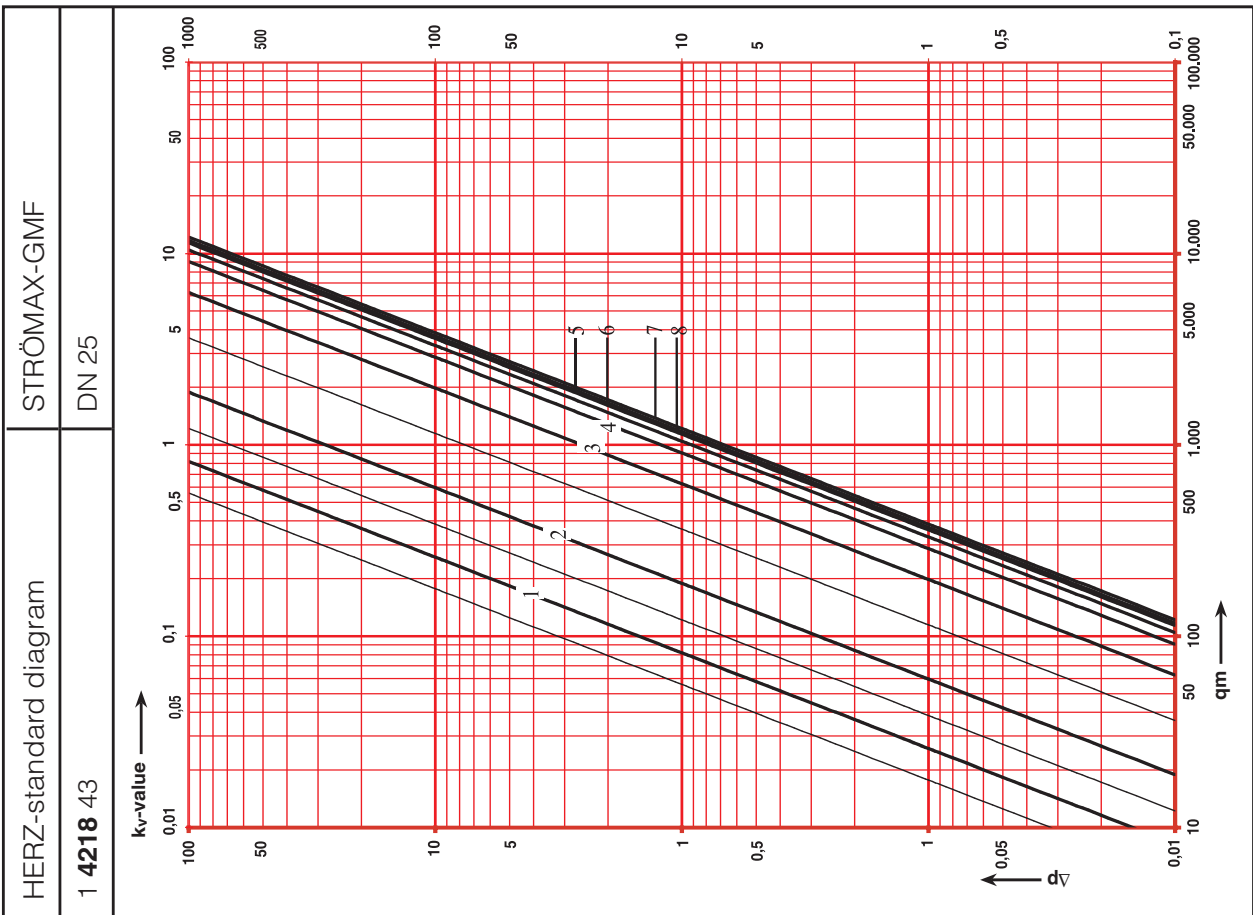
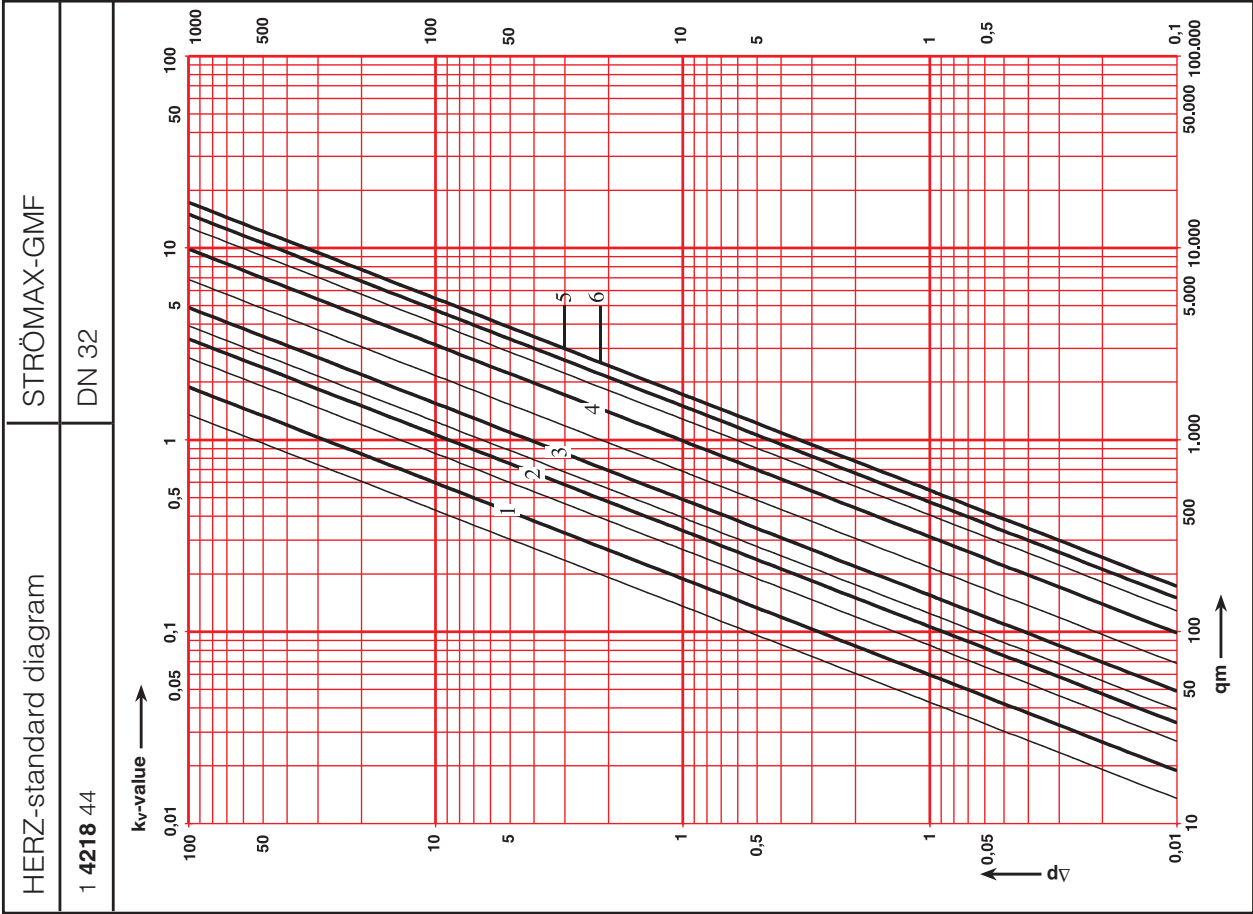

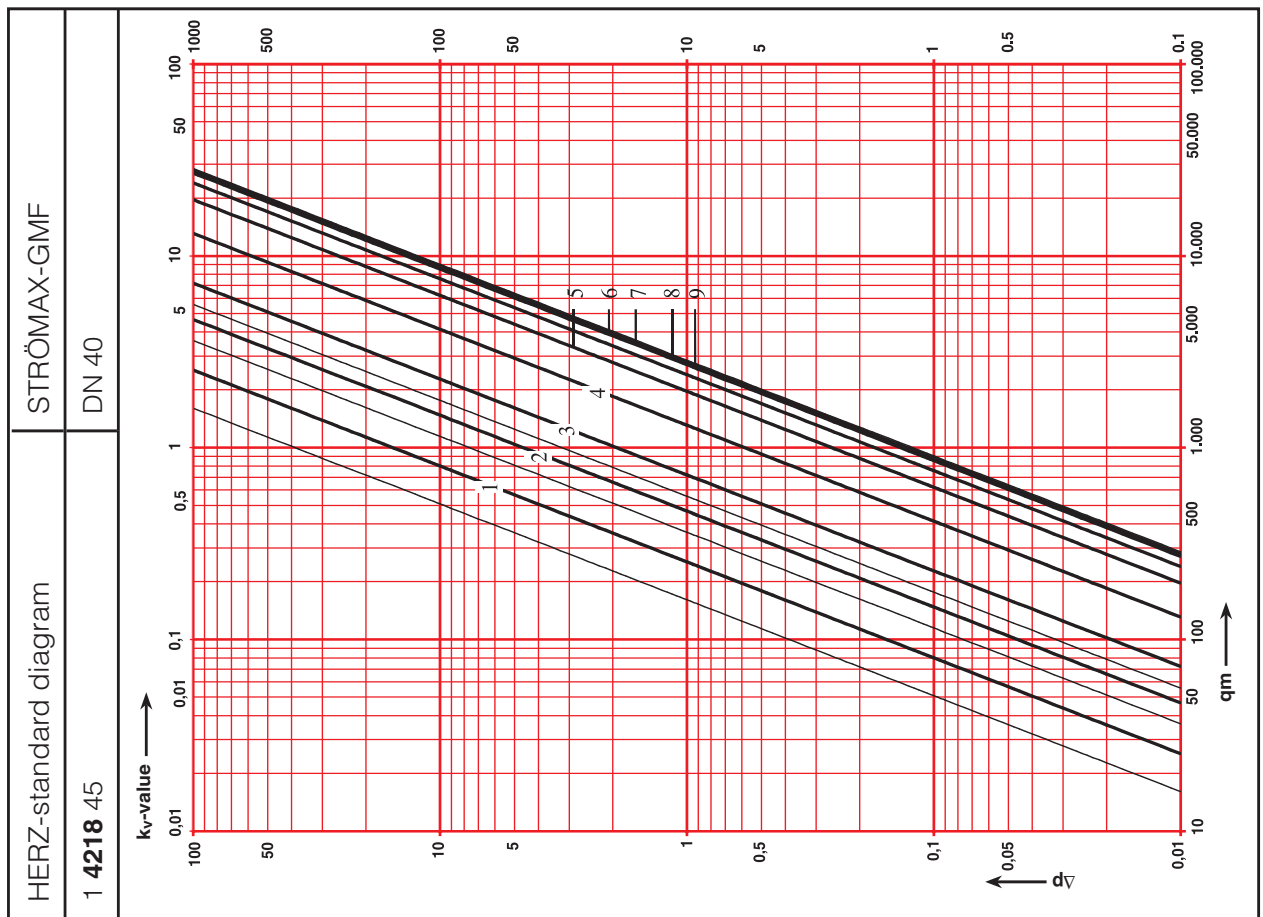
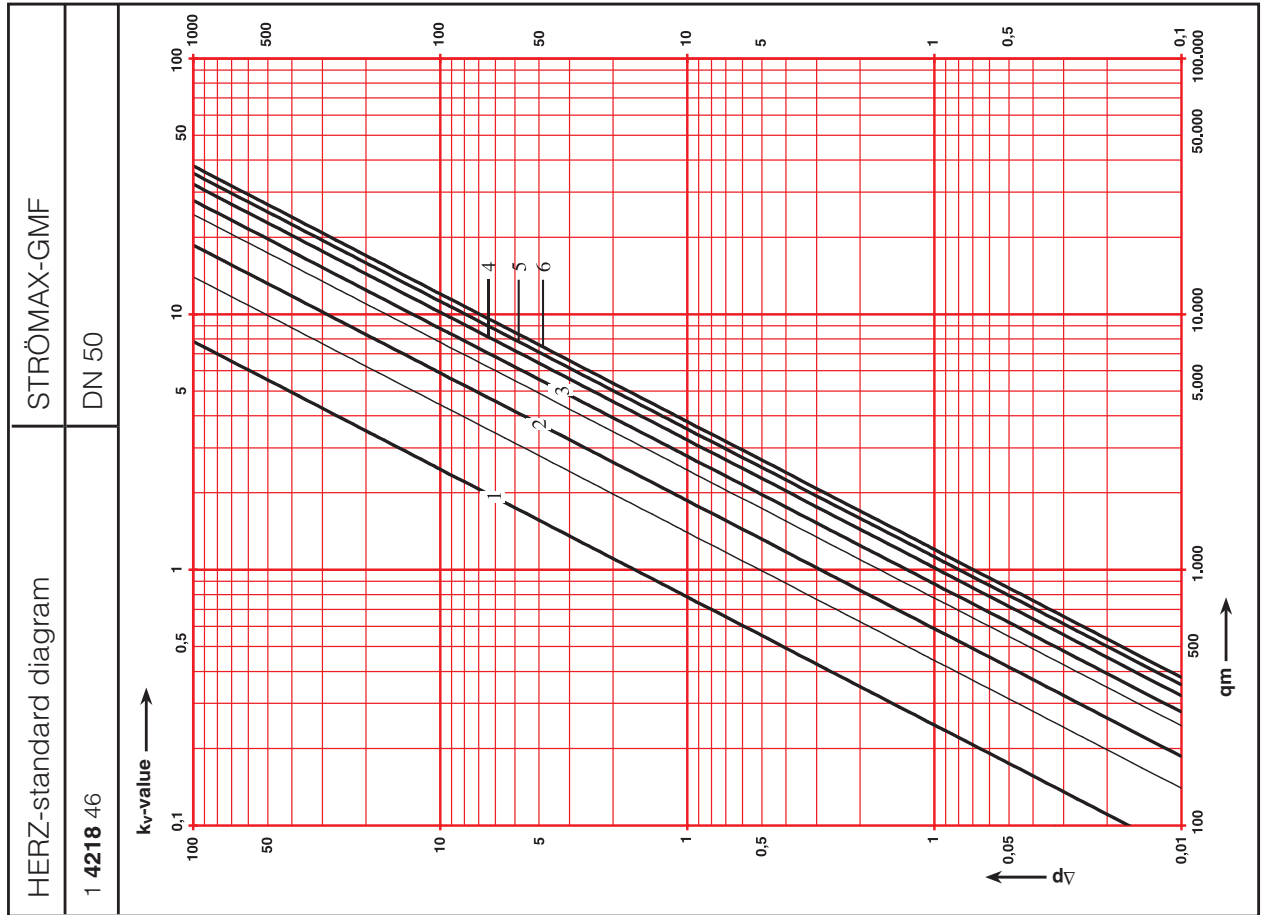

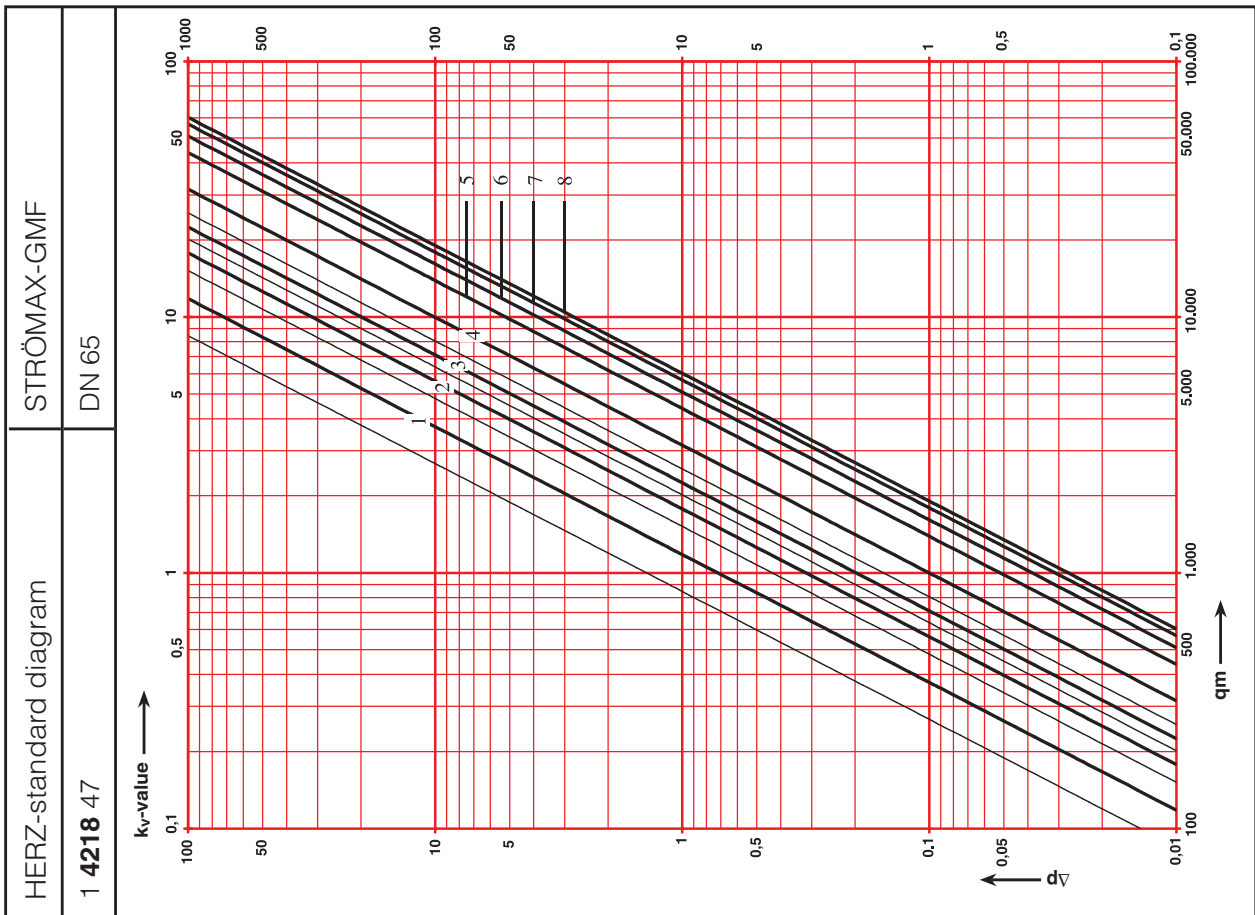
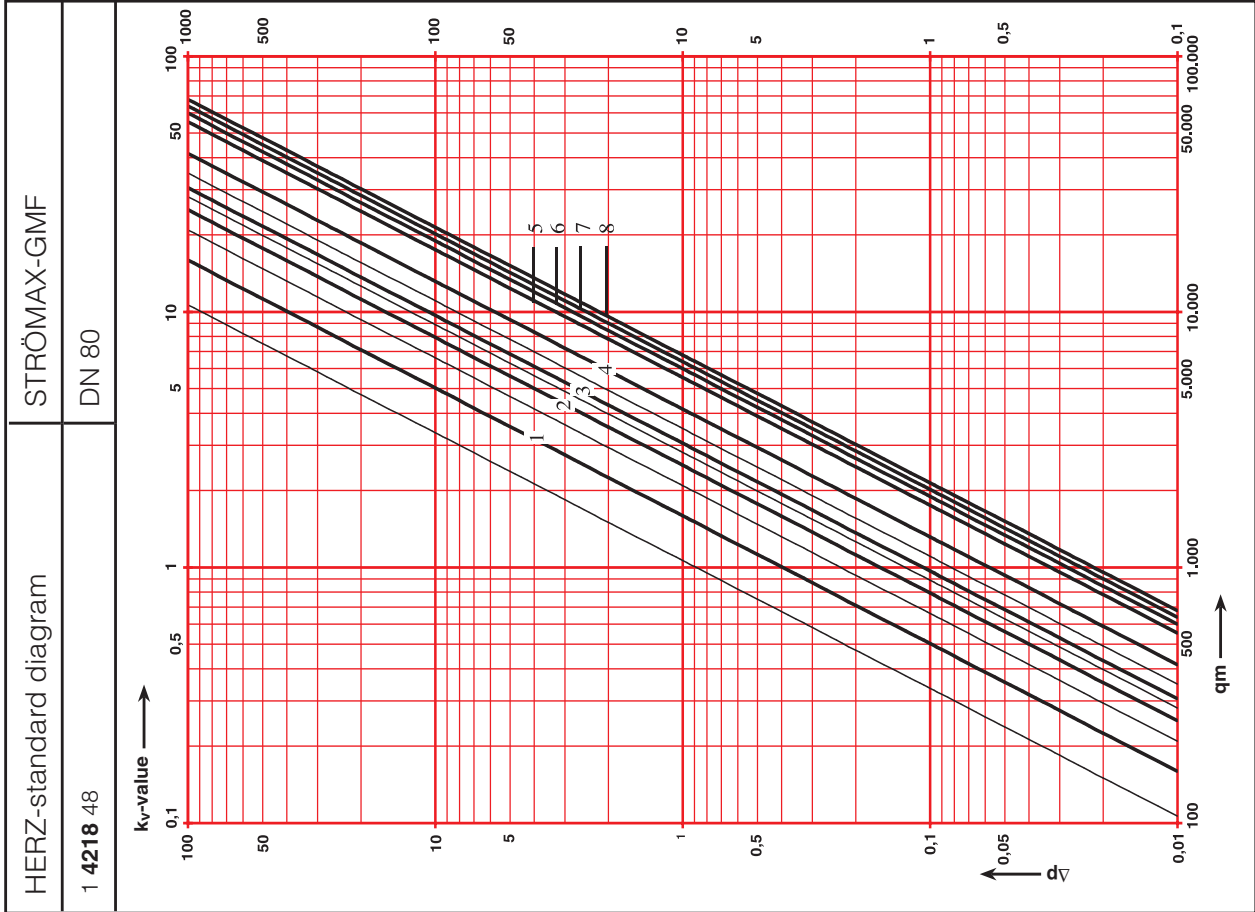

HERZ-standard diagram	STRÖMAX 4218 GMF
-----------------------	------------------

1 4218 49	DN 100
-----------	--------

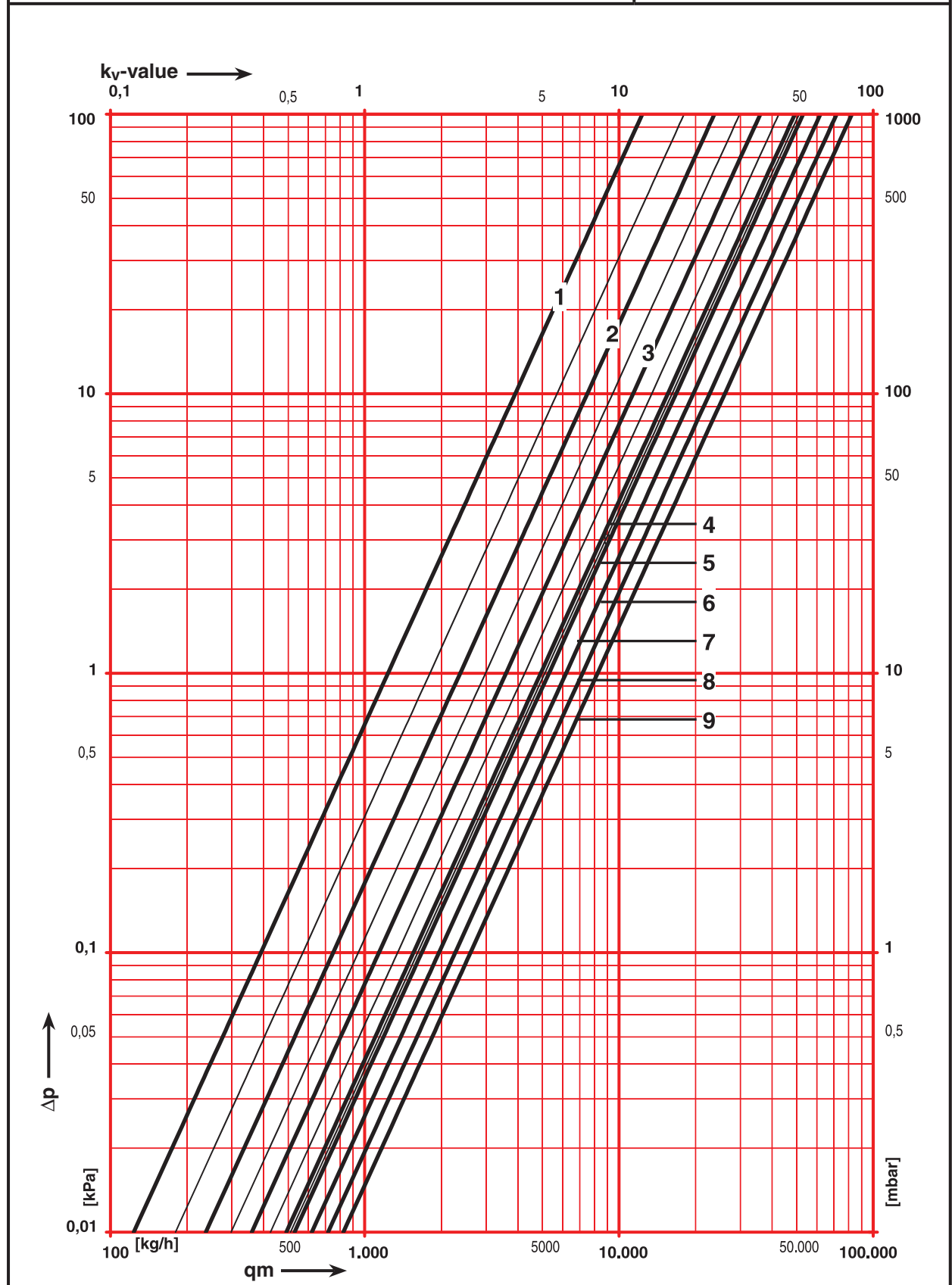

HERZ-standard diagram STRÖMAX 4218 GMF

1 4218 50 DN 125

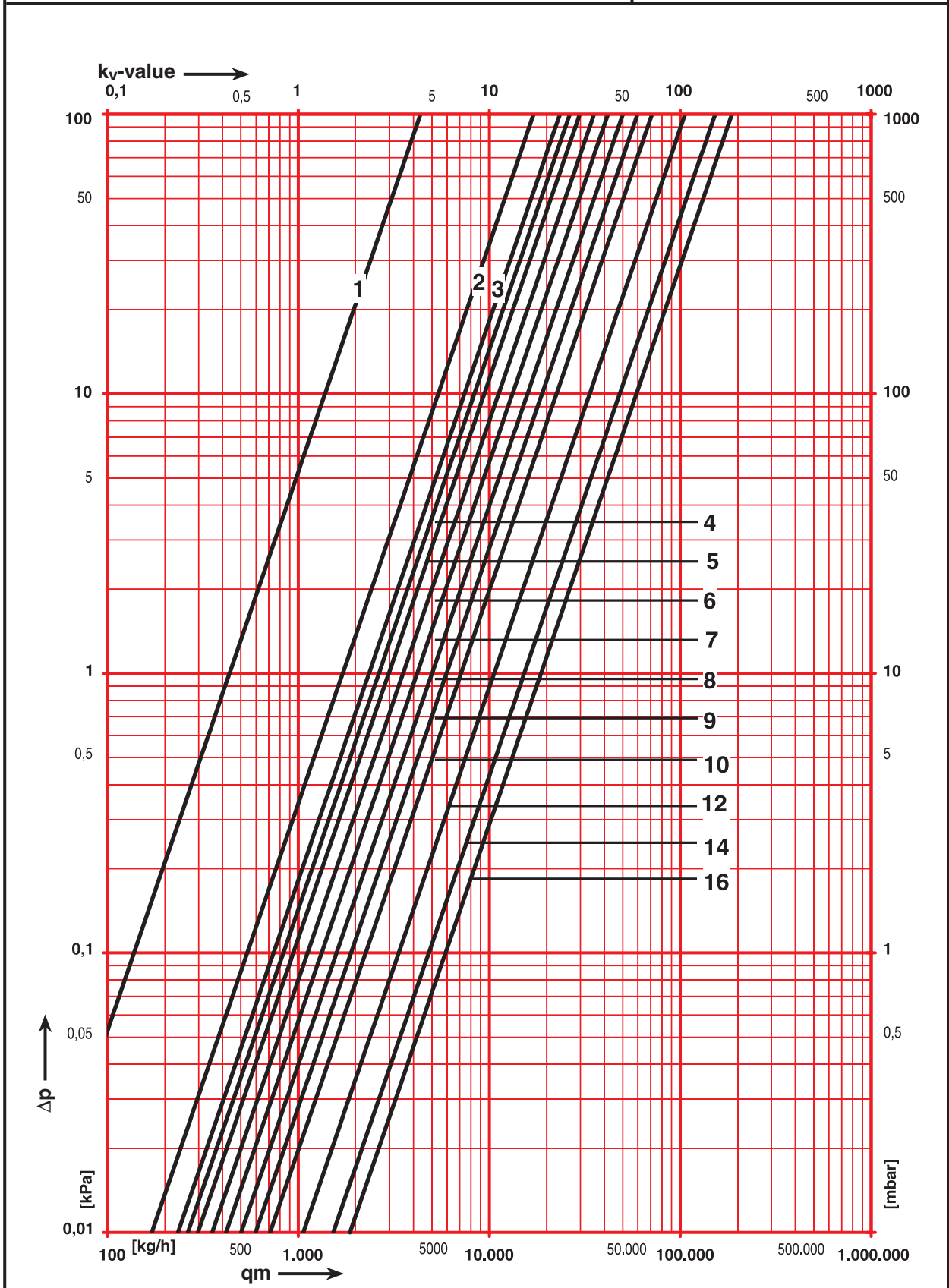

HERZ-standard diagram STRÖMAX 4218 GMF

1 4218 51 DN 150

