

HERZ Datasheet collection. Actuators.

Datasheet 7712 2X,3X, Issue 0622

List of contents:

- Rotary actuator 7712 33,35 for ball valves with/without SUT*.....2
- Valve actuator with SUT* postioner 7712 32,21.....8
- Damper actuator with/without SUT* 7712 25, 2715
- Valve actuator 7712 30, 3120
- Valve actuator 7712 28, 2928
- Selection matrix 33

General information

Intended use

Products, which are represented in this document are suitable only for the purpose intended by the manufacturer, as described in the “Description of operation” section.

All related product regulations must also be adhered to. Changing or converting of the products is not admissible.

Outdoor installation

We recommend protecting the devices from the weather if they are installed outside buildings.

Disposal

When disposing of the product, observe the currently applicable local laws.

Selection matrix

In order to select a right actuator please refer to the selection matrix. The procedure is as follows: green marked cells in the table means that the actuator is suitable to work with corresponding valve. Order numbers in green highlighted cells corresponds to the adapter **which has to be ordered separately**. If the cell is marked with green color, but has no order number inside, this means that actuator is suitable for the direct mounting without additional adapters.

* SUT functionality combines all possible operating modes and control options in one actuator

All specifications and statements within this document are according to information available at the time of printing and meant for informational purpose only. Herz Armaturen reserves the right to modify and change products as well as its technical specifications and/or its functioning according to technological progress and requirements. It is understood that all images of Herz products are symbolic representations and therefore may visually differ from the actual product. Colours may differ due to printing technology used. In case of any further questions do not hesitate to contact your closest HERZ Branch-office.

HERZ - Rotary actuator for ball valves

Datasheet 7712 33,35, Issue 0622

☑ Dimensions in mm

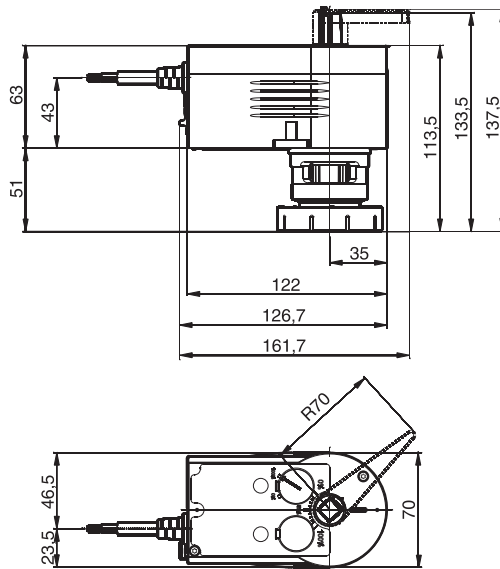

☑ Models

- 1 **7712 33** Rotary actuator for ball valves
Torque 8 Nm, Voltage AC 230 V, Control: 2-/3-point
for HERZ ball valves 1 2117...
- 1 **7712 35** Rotary actuator for ball valves
Torque 8 Nm, Voltage AC/DC 24 V, Control: 2-/3-point, constant
for HERZ ball valves 1 2117...

☑ Features

1 7712 33:

- For controllers with a switching output (2-/3-point control)
- Fitted to ball valves up to DN 50 without the need to use tools
- Synchronous motor with electronic activation and cut-out
- Maintenance-free gear unit
- Gear unit can be disengaged in order to position the ball valve manually (using the lever)
- Bracket and bayonet ring made of glass-fibre-reinforced plastic for fitting onto ball valve
- Fitting vertically upright to horizontal, not suspended

1 7712 35:

- For controllers with constant output (0...10 V) or switching output (2-/3-point control)
- Assembly with ball valve without the use of tools
- Stepping motor with SUT electronic control unit
- Electronic force-dependent motor cut-off

- Automatic recognition of applied control signal (continuous or switched)
- Coding switch for selection of characteristic and running time (35 s, 60 s, 120 s)
- Type of characteristic (linear/quadratic/equal-percentage) can be set on the actuator
- Direction of operation can be selected directly on the cable
- Maintenance-free gear unit
- Gear unit can be disengaged in order to position the ball valve manually (using the lever)
- Bracket and bayonet ring made of glass-fibre-reinforced plastic for fitting onto ball valve

☑ Technical data

General

Ambient conditions

Admissible ambient temperature	-10...55 °C
Admissible ambient humidity	5...95% rF without condensation
Temperature of medium	Max. 100 °C

Construction

Weight	0,7 kg
Housing	Lower section black, upper section red
Housing material	Fire-retardant plastic

1 7712 33:

Power supply	
Supply voltage 230 V~	±15%, 50...60 Hz
Power cable	1,2 m, 3 × 0,75 mm ²
Response time	Min. 200 ms
Angle of rotation	90°
Control	2-/3-point

Standards and directives

Type of protection	IP 54 acc. to EN 60529
Protection class	II acc. to IEC 60730
Over-voltage categories	III
Degree of contamination	II

CE conformity according to	Directive 2014/35/EU EN 60730-1/EN 60730-2-14 EMV Directive 2014/30/EU EN 61000-6-1, EN 61000-6-2 EN 61000-6-3, EN 61000-6-4
----------------------------	--

1 7712 35:

Power supply	
Supply voltage 24 V~	±20%, 50...60 Hz
Supply voltage 24 V=	-10%...20%
Power consumption	5,4 W/9,5 VA
Running time	35/60/120 s
Angle of rotation	90°
Response time	200 ms
Power cable	1,2 m, 5 × 0,5 mm ²

Positioning signal y	0...10 V, $R_i > 100 \text{ k}\Omega$
Positioning feedback signal	0...10 V, Load $> 10 \text{ k}\Omega$
Starting point U0	0 V or 10 V
Control span ΔU	10 V
Switching range Xsh	200 mV
Installation	vertically upright to horizontal, not suspended

Standards and Directives

Type of protection	IP54 nach EN 60529		
Protection class	III nach IEC 60730		
CE conformity according to	EMC Directive 2014/30/EU	EN 61000-6-1, EN 61000-6-3	
	EN 61000-6-4	Directive 2014/35/EU	Machine directive (EN 1050)

Description of operation

1 7712 33:

When voltage is applied to the cable, the control unit to be activated is moved to any desired position by means of the carrier stem.

Direction of rotation for 3-point control (viewing the spindle of the ball valve from the actuator):

- The stem turns in the anti-clockwise direction, with the voltage on the brown cable, and the through passage of the ball valve is opened.
- The stem turns in the clockwise direction, with the voltage on the black cable, and the through passage of the ball valve is closed.

With 3-point control, the direction of rotation is changed by swapping the connections.

Direction of rotation for 2-point control (viewing the spindle of the ball valve from the actuator):

There is always voltage on the black cable.

- The stem turns in the anti-clockwise direction, with the voltage on the brown cable, and the ball valve is opened.
- The stem turns in the clockwise direction, with no voltage on the brown cable, and the ball valve is closed.

In the end positions (limit stop in actuator), or in the case of an overload, the magnetic coupling is activated. The positioning signal is switched off by the electronic cut-out after 3 minutes. The manual adjustment is performed by releasing the gear unit (slide switch beside the connection cable) and simultaneously turning it with the lever. The actuator position can be determined by looking at the lever or the indicator knob on the top part of the actuator.

1 7712 35:

Depending on the type of connection (see connection diagram), the actuator can be used as a continuous 0...10 V, 2-point (OPEN/CLOSE) or 3-point actuator with an intermediate position (OPEN/STOP/CLOSE). The running time of the actuator can be set with the coding switch according to requirements. The coding switch can be used to select the equal-percentage, linear or quadratic characteristic. The HERZ rotary actuator 1 7712 35 is combined with ball valves that have an equal-percentage basic characteristic. The manual adjustment is performed by releasing the gear unit (slide switch beside the connection cable) and simultaneously turning it with the lever. The actuator position can be determined by looking at the lever or the indicator knob on the top part of the actuator.

Note: After manually adjusting the slide switch, put it back into its original position (engage gear unit).

Additional technical data

The upper section of the housing with the cover, indicator knob and cover knob contains the stepping motor and the SUT electronics. The lower section of the housing contains the maintenance-free gear unit.

☑ Connection diagram

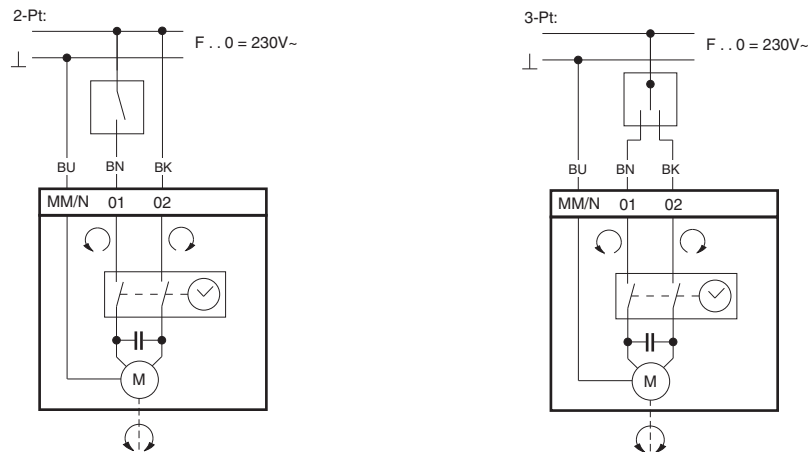

1 7712 35:

Connection as 2-point actuator

This OPEN/CLOSE activation can be performed via 2 cables. The actuator is connected to the voltage via the blue and brown cables. The control passage of the ball valve is opened by connecting the voltage to the black cable. After this voltage is switched off, the actuator moves to the opposite end position and closes the ball valve.

The unused red and grey wires must not be connected or come into contact with other cables. We recommend that you insulate these.

Connection as 3-point control unit

When voltage is applied to the cable (brown or black), the ball valve is moved to any desired position.

Direction of rotation (viewing the spindle of the ball valve from the actuator):

- The stem turns in the clockwise direction, with voltage on the brown cable, and closes the ball valve.
- The stem turns in the anti-clockwise direction, with the voltage on the black cable.

In the end positions (limit stop in actuator, max. angle of rotation of 95° reached) or in the case of an overload, the electronic motor cut-off is activated (no limit switches). Direction of rotation changed by transposing the connections.

The unused red and grey wires must not be connected or come into contact with other cables. We recommend that you insulate these.

Connection for control voltage 0...10 V

The built-in positioner controls the actuator depending on controller's output signal y . Direction of rotation (viewing the spindle of the ball valve from the actuator):

Direction of operation 1 (mains power supply on brown cable):

When the positioning signal is increasing, the carrier stem turns in the anti-clockwise direction and opens the control passage of the ball valve.

Direction of operation 2 (mains power supply on black cable):

When the positioning signal is increasing, the carrier stem turns in the clockwise direction and closes the control passage of the ball valve.

The starting point and control span are fixed. Only the brown cable or the black cable may be connected to the voltage. The cable not used must be insulated (if not connected via switch).

After a manual adjustment or a power failure of more than at least 5 min, the actuator automatically readjusts itself, always with a running time of 60 s.

After the power supply is connected, the stepping motor moves to the 100% position, makes the connection with the carrier stem, and then moves to the 0% position and thus defines the working range. After this, every position between a 0 and 90 ° angle of rotation can be achieved, depending on the control voltage. Thanks to the electronics, no steps can be lost, and the actuator does not require periodic re-adjustment. It is possible to operate multiple actuators of the same type in parallel. The feedback signal $y_0 = 0 \dots 10 \text{ V}$ corresponds to the effective angle of rotation of $0 \dots 90^\circ$.

When control signal $0 \dots 10 \text{ V}$ is interrupted and direction of operation 1 is connected, the ball valve is closed completely (0% position).



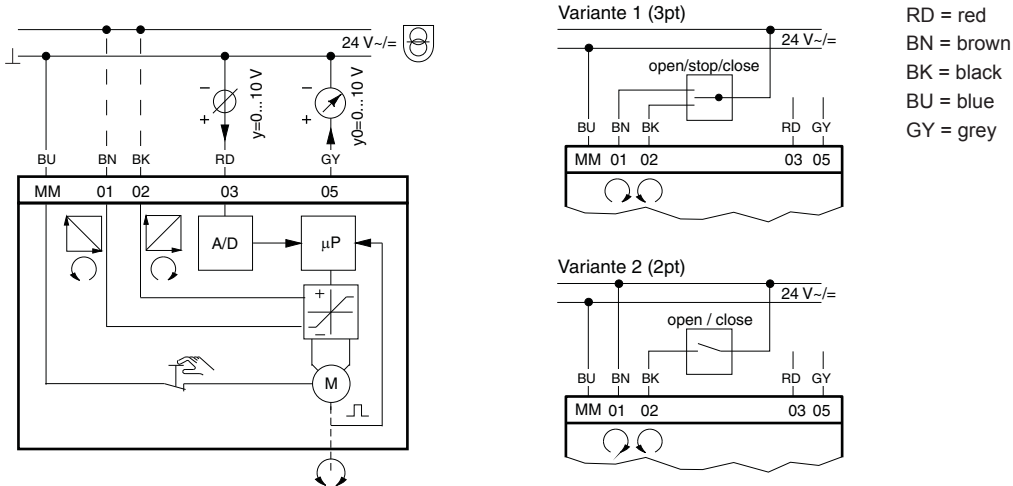

The coding switch can be used to select the characteristic of the ball valve. Characteristics can only be generated when the actuator is used as a continuous actuator. The running times can be selected with additional switch settings. These can be used regardless of whether the 2-point, 3-point or continuous function is selected.

Connection diagram

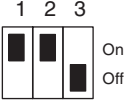
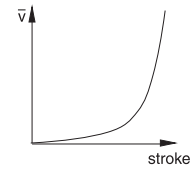
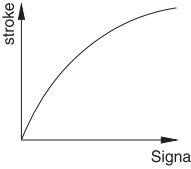
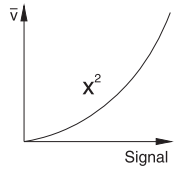
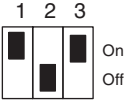
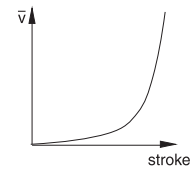
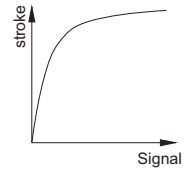
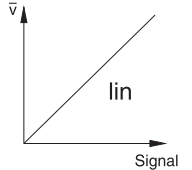

☑ Coding switch for running time and characteristic selection

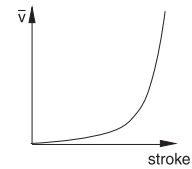
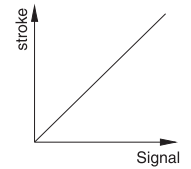
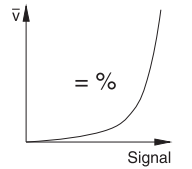
switch position				running time/angle of rotation s/90°
				120 s ± 4

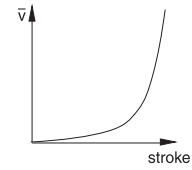
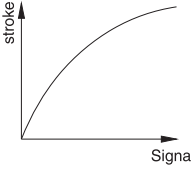
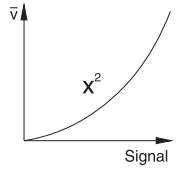
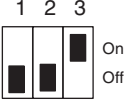
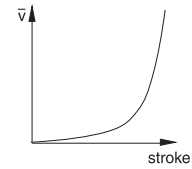
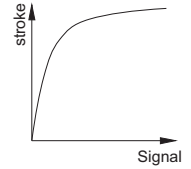
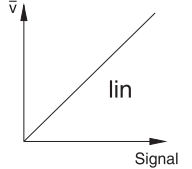
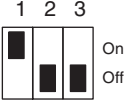
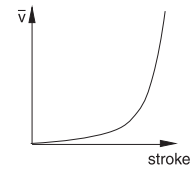
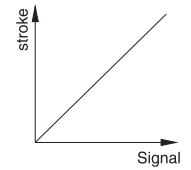
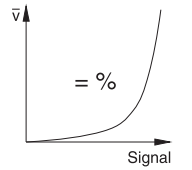
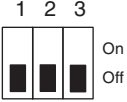
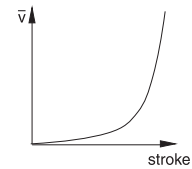
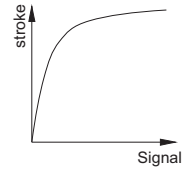
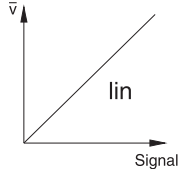
				120 s ± 4
				120 s ± 4
				60 s ± 2
				60 s ± 2
				60 s ± 2
				35 s ± 1
				35 s ± 1

☑ Notes on engineering and installation

Condensate, dripping water, etc. must be prevented from entering the actuator along the carrier stem. When connecting the electricity supply, ensure that the cross-section of the power cable is adapted to the power output and the length. However, we recommend a minimum cross-section of 0.75 mm². The actuator/ball valve is mounted by inserting and turning the bayonet ring until the limit stop without any additional adjustment. No tools are required. The coupling of the spindle of the ball valve with the carrier stem is performed automatically, either by moving the manual adjuster to an angle of rotation of 100% or connecting the voltage. For dismantling, the bayonet ring is simply opened and the actuator removed. The device is delivered ex works in the middle position.

The concept of stepping motor and electronics enables parallel operation of multiple actuators of the same SUT type.

The coding switches are accessible via an opening with a black cover in the housing lid.

Note The housing must not be opened.

HERZ Valve actuator with SUT postioner

Datasheet 7712 32,21, Issue 0622

☑ Dimensions in mm

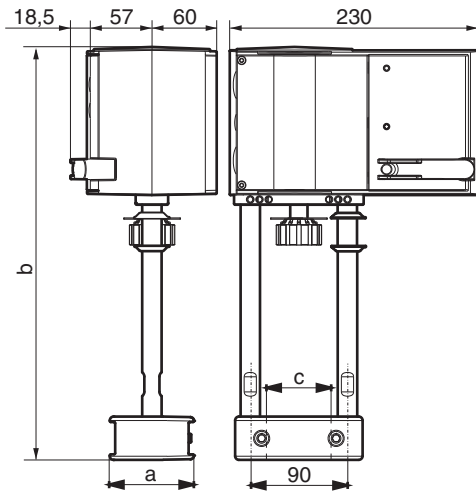

Model	a	b	c
1 7712 32	58	289	38
1 7712 21	78	382	60

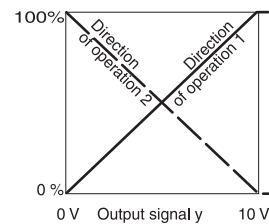

☑ Models

1 7712 32 Valve actuator
 Actuating power 2500 N, Voltage AC/DC 24 V, Control: 2-/3-point, constant
 For 2 and 3 way valves (for more details, please refer to selection matrix)

1 7712 21 Valve actuator
 Actuating power 2500 N, Voltage AC/DC 24 V, Control: 2-/3-point, constant
 For flow control valves (for more details, please refer to selection matrix)

☑ Features

- For controllers with constant output (0...10 V or 4...20 mA) or switching output (2-point or 3-point control)
- Stepping motor with SUT electronic control unit and electronic, force-dependent cut-off
- Simple assembly with valve; spindle is automatically connected after control voltage is applied
- Automatic detection of applied control signal (constant or switched); indicated by two LEDs
- Coding switches for selecting characteristic and running time
- Type of characteristic (linear/quadratic/equal-percentage) can be set on the actuator
- Automatic adaptation to the stroke of the valve (min. valve stroke 8 mm, max. valve stroke 49 mm). The measured stroke is saved and is not lost even in the event of a power failure
- Direction of operation can be selected via screw terminals when making the electrical connection

- Crank handle for external manual adjustment with motor cut-off and as trigger for a re-initialisation
- Power supply 230 V with module or direct connection for 24 V~ / 24 V=; continuous activation also admissible with 230 V
- Maintenance-free gear unit made of sintered steel; gearbox base-plate made of steel
- Mounting column made of stainless steel; mounting bracket made of cast light alloy for fitting the valve
- Electrical connections (max. 2.5 mm²) with screw terminals
- Three break-out cable inlets for M20 × 1.5 (2×) and M16 × 1.5
- Fitting vertically upright to horizontal, not suspended

☑ Technical data

General

Power Supply

Supply voltage 24 V~	±20%, 50...60 Hz
Supply voltage 24 V=	±15%
Supply voltage 230 V~	±15% (with accessory)
Power consumption	24 V~/24 V=: 10 W/20 VA 230 V~ (with accessory):13 W/28 VA

Construction

Weight	4,1 kg
Housing	Two part, red
Housing material	Flame-retardant plastic

Parameters

Running time	2/4/6 s/mm
Actuating power	2500 N
Actuator stroke	0...49 mm
Response time for 3-point	200 ms
Positioner	
Control signal 1	0...10 V, Ri >100 kΩ
Control signal 2	4...20 mA, Ri = 50 Ω
Positioning feedback signal	0...10 V, load > 2,5 kΩ
Starting point U0	0 bzw. 10 V
Control span ΔU	10 V
Switching range Xsh	300 mV
Ambient conditions	
Adm. ambient temperature	-10...55 °C
Adm. ambient humidity	< 95 % rF no condensation
Temperature of medium	Max. 130 °C

Standards, directives

Type of protection	IP 66 (EN60529)
Protection class	III (IEC 60730)
EMC-Directive	EN 61000-6-2, EN 61000-6-4 2014/30/EU
Low-voltage directive	EN 60730-1, EN 60730-2-14 2014/35/EU
Over-voltage category	III
Verschmutzungsgrad	III

☑ Description of operation

Depending on the type of connection (see connection diagram), the actuator can be used as a continuous (0...10 V and/or 4...20 mA), 2-point (OPEN/CLOSE) or 3-point actuator (OPEN/STOP/CLOSE).

The running time of the actuator can be set with switches S1 and S2 according to the relevant requirements. Switches S3 and S4 are used to configure the characteristic (equal-percentage, linear or quadratic).

The external crank handle enables manual positional setting. When the crank handle is folded out, the motor is switched off. After the crank handle is folded back, the target position is approached again (without initialisation). When the crank handle is folded out, the actuator remains in this position.

☑ Connection diagram (24 V)

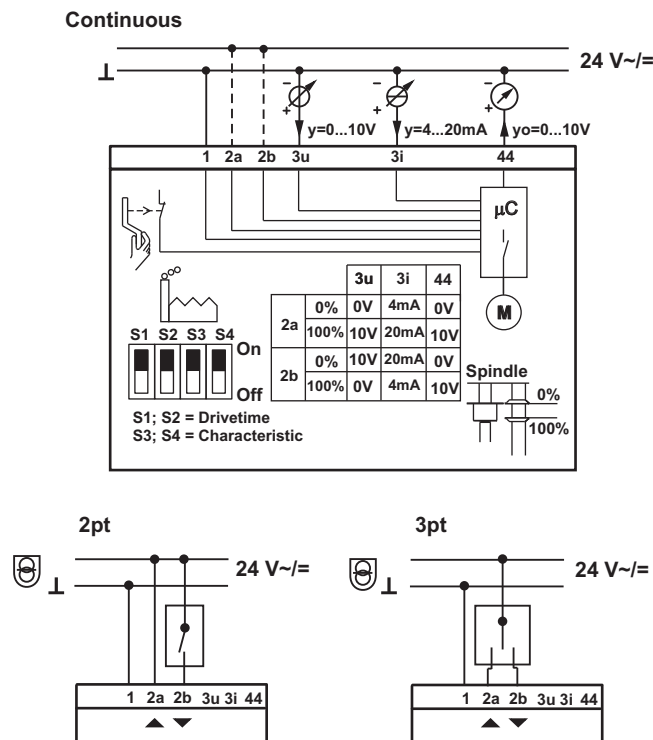

Connection as 2-point valve actuator (24 V)

This activation (OPEN/CLOSE) can be performed via two wires. The voltage is applied to terminals 1 and 2a. When voltage (24 V) is applied to terminal 2b, the actuator spindle moves out. After this voltage is switched off, the actuator moves to the opposite end position. In the end positions (valve limit stop or maximum stroke reached) or in the case of an overload, the electronic motor cut-off is activated (no limit switches).

The running times can be set using the coding switch. The characteristic cannot be selected here (the result is the characteristic of the valve). Terminals 3i, 3u and 44 must not be connected.

Connection as 3-point valve actuator (24 V)

If voltage is applied to terminal 2a (or 2b), the valve can be moved to any desired position. If voltage is applied to terminals 1 and 2b, the actuator spindle moves out. It moves in when the electrical circuit is closed via terminals 1 and 2a.

In the end positions (valve limit stop or maximum stroke reached) or in the case of an overload, the electronic motor cut-off is activated (no limit switches). The direction of the stroke can be changed by swapping the connections.

The running times are set using the coding switch. The characteristic cannot be selected here (the result is the characteristic of the valve). Terminals 3i, 3u and 44 must not be connected.

Connection with 230 V or 100...110 V as 2-point/3-point or with continuous activation of valve actuator (accessory 1 7712 22)

The built-in positioner controls the actuator depending on controller's output signal y.

A voltage signal (0...10 V-) at terminal 3u or a current signal at terminal 3i serves as the control signal.

If there is a control signal at the two terminals (3u (0...10 V) and 3i (4...20 mA)) at the same time, the input with the higher value has priority.

Direction of operation 1 (mains power supply on internal connection 2a):

When the positioning signal is increasing, the actuator spindle moves out.

Direction of operation 2 (mains power supply on internal connection 2b):

When the positioning signal is increasing, the actuator spindle moves in.

The starting point and control span are fixed. To set partial ranges, a split-range unit is available as an accessory (only for voltage input 3u) – see the split-range unit function – which is intended to be installed in the actuator.

After the connection of the power supply and the initialisation, the actuator moves to every valve stroke between 0% and 100%, depending on the control signal. Thanks to the electronics and the travel measurement system, no stroke is lost, and the actuator does not require periodic re-initialisation.

When the end positions are reached, this position is checked, corrected if necessary, and saved again. It is thus possible to operate multiple actuators of the SUT type in parallel. The feedback signal $y_0 = 0...10\text{ V}$ corresponds to the effective stroke of 0 to 100%.

If the control signal 0...10 V or 4...20 mA is interrupted with direction of operation 1, the actuator spindle moves in completely, or moves out completely with direction of operation 2.

The coding switch can be used to set the characteristic of the valve. An equal-percentage or quadratic characteristic can only be generated when the actuator is used as a continuous actuator. Additional switches can be used to select the running times (with the 2-point, 3-point or continuous functions).

Continuous actuation can also be used with a power supply of 230 V or 110 V (accessory required). You must ensure that the neutral wire of the controller is connected to the control voltage. The neutral wire of the power supply may only be used for the module.

Connection with 230 V (with plug-in module 1 7712 22)

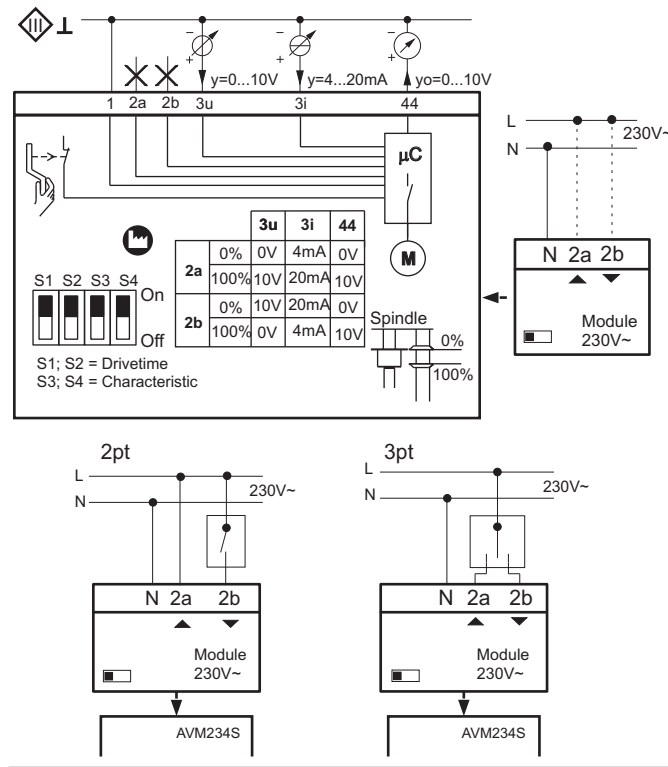

☑ Initialisation and feedback signal

The actuator initialises itself autonomously when it is connected as a continuous actuator. Once a voltage is applied to the actuator for the first time, the actuator moves to the lower limit stop of the valve and thus enables automatic connection with the valve spindle. Then it moves to the upper stop and the value is detected and saved via a travel measurement system. The control signal and the feedback are adjusted to this effective stroke. In case of a power failure or the removal of the power supply, no re-initialisation is carried out. The values remain saved.

For a re-initialisation, the actuator must be connected to the power supply and there must be a constant input signal at 3u or 3i. An initialisation is triggered by folding the crank handle out and back twice within 4 s. Then the two LEDs flash red.

During initialisation, the feedback signal is inactive or equal to the value “0”. Initialisation is carried out with the shortest running time. The re-initialisation is only valid when the whole process is complete. Folding the crank handle out again interrupts this process.

If the actuator detects jamming, it reports this by setting the feedback signal to 0 V after approx. 90 s. During this time, the actuator tries to overcome the jamming. If the jamming can be overcome, the normal control function is activated again, and the feedback signal is restored. With 2-point or 3-point control, no initialisation is performed. The feedback signal is inactive.

☑ LED indicator: The indicator consists of bi-colour LEDs (red / green).

Both LEDs flash red	Initialisation
Top LED lights up red	Top limit stop or “CLOSED” position reached
Bottom LED lights up red	Bottom limit stop or “OPEN” position reached
Top LED flashes green	Actuator is running, moving to “CLOSED” position
Top LED lights up green	Actuator is stopped, last direction of travel “CLOSED”
Bottom LED flashes green	Actuator is running, moving to “OPEN” position
Bottom LED lights up green	Actuator is stopped, last direction of travel “OPEN”

No LED lights up	No power supply (terminal 2a or 2b)
Both LEDs flash red and green	Actuator is in manual mode

Additional technical information

The red housing, consisting of the front part, rear part and connecting lid, only serves as a cover.

The DC motor, electronic control unit, load-bearing section and maintenance-free gear unit are located in the housing. The actuator spindle and the column are made of rust-proof material. The inner printed circuit boards and the gear unit are made of steel. The valve spindle guide and the valve neck coupling are made of die-cast aluminium.

Note on ambient temperatures: With a media temperature of up to 110°C in the valve, the ambient temperature is allowed to reach 60°C.

Engineering and fitting notes

Condensate, dripping water, etc. must be prevented from entering the actuator along the valve spindle.

The valve is mounted directly on the actuator and fixed with screws (no further adjustments are required).

The actuator is connected with the valve spindle automatically. As delivered ex works, the actuator spindle is in the middle position. The housing contains three break-out cable inlets which are broken out automatically when the cable inlet is screwed in. The concept of stepping motor/electronics enables parallel operation of multiple valve actuators of the same type. The cross-section of the power cable must be selected based on the cable length and the number of actuators. With five actuators wired in parallel and a cable length of 50 m, we recommend a cable cross-section of 1.5 mm² (power consumption of the actuator × 5).

Warning

If there is a high media temperature in the valve, the actuator columns and the spindle can attain similarly high temperatures. If damage can occur due to the failure of the control unit, additional protective measures must be implemented.

Coding switch for running time and characteristic selection

Run time per mm	Switch coding	Run time for 14 mm stroke	Run time for 20 mm stroke	Run time for 40 mm stroke
2s		28s ± 1	40s ± 1	80s ± 4
4s		56s ± 2	80s ± 4	160s ± 4
6s		84s ± 4	120s ± 4	240s ± 8
= factory setting				

Desired character. curve	Switch coding	Characteristic curve for valve	Characteristic curve for drive	Effective on valve
Equal percentage				
Quadratic				
Linear				
Equal percentage				
Linear				
= factory setting				

Accessory

1 7712 22

230 V $\pm 15\%$, Supply voltage Plug-in modules for 2-/3-point and constant control, additional power 2 VA

HERZ Damper actuator with/without SUT

Datasheet 7712 25, 27, Issue 0622

☑ Dimensions in mm

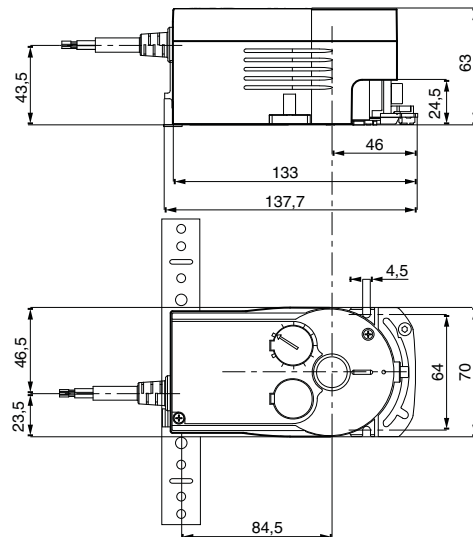

☑ Models

- 1 7712 25 Damper actuator
Torque 10 Nm, Supply voltage AC 230 V, Control: 2-/3-point
for HERZ 3 way valve 1 2137 XX
- 1 7712 27 Damper actuator with SUT
Torque 10 Nm, Supply voltage AC/DC 24 V, Control: 2-/3-point, constant
for HERZ 3 way valve 1 2137 XX

☑ Features

- For controllers with switching (2- and 3-point) or continuous output (0...10 V, 1 7712 27 only)
- Self-centring spindle adapter
- Gear unit can be disengaged to position the damper and for manual adjustment
- Stepping motor with electronic activation and cut-out
- Maintenance-free
- Intelligent adaptation of angle of rotation, incl. feedback adjustment (1 7712 27 only)
- Suitable for all fitting positions

☑ Technical data

General

Construction

Weight	0,7 kg
Housing	Lower section black, upper section red
Housing material	Fire-retardant plastic
Power cable	1,2 m, 3×0,75 mm ² (1 7712 25) 1,2 m, 5×0,5 mm ² (1 7712 27)

Parameters

Angle of rotation	95°
Admissible damper shaft	Ø 8...16 mm, □ 6,5...12,5 mm
Adm.. damper shaft (hardness)	Max. 300 HV
Operating noise	< 30 dB (A)
Response time	200 ms

1 7712 25:

Ambient conditions	
Adm. ambient temperature	-20...65 °C
Adm. ambient humidity	5...85 % rF no condensation
Control	2-/3-point
Supply voltage	AC 230 V

Type of protection	IP 54 according to EN 60529
Protection class 230 V	II according to IEC 60730

CE conformity according to	EMC-Richtlinie 2014/30/EU EN 61000-6-1, EN 61000-6-2 EN 61000-6-3, EN 61000-6-4 Directive 2014/35/EU EN 1050 Low-voltage directive EN 60730-1, EN 60730-2-14
----------------------------	--

Over-voltage category	III,
Degree of contamination	II

1) Operating time approx. 80% up to 65 °C, 100% up to 55 °C

1 7712 27:

Power supply	
Supply voltage 24 V~	±20%, 51...60 Hz
Supply voltage 24 V=	±20%

Positioner

Control signal y	0...10 V, Ri > 100 kΩ
Positional feedback	0...10 V, load > 10 kΩ
Starting point U0	0 V or 10 V
Control span ΔU	10 V
Switching range Xsh	200 mV

Ambient conditions

Adm. Ambient temperature	-20...55 °C
Adm. ambient humidity	< 95% rF no condensation

Type of protection	IP54 according to EN 60529
Protection class	III according to IEC 60730
CE conformity according to	EMV-directive 2014/30/EU EN 61000-6-1, EN 61000-6-3 EN 61000-6-4 Directive 2014/35/EU Machine directive (EN 1050)

☑ Description of operation

1 7712 25:

When voltage is applied to the cable, the control unit to be activated is moved to any desired position.

Direction of rotation for 3-point control (viewing the spindle adaptor from the actuator):

- The spindle adaptor turns in the clockwise direction, with the voltage on the brown cable.
- The spindle adaptor turns in the anti-clockwise direction, with the voltage on the black cable.

Direction of rotation for 2-point control (viewing the spindle adaptor from the actuator):

There is always voltage on the black cable.

- The spindle adaptor turns in the clockwise direction, with the voltage on the brown cable.
- The spindle adaptor turns in the anti-clockwise direction, with no voltage on the brown cable.

In the end positions (limit stop in air damper or maximum angle of rotation reached), or in the case of an overload, the magnetic coupling is activated. The positioning signal is switched off by the electronic cut-out after 3 minutes. The effective end position results from the limit stop of the damper or the angle-of-rotation limit, or by reaching the maximum angle of rotation of 95°. The manual adjustment is performed by releasing the gear unit using the adjuster beside the connection cable and simultaneously adjusting the spindle adaptor. With 3-point control, the direction of rotation is changed by swapping the connections.

1 7712 27:

Depending on the type of connection (see connection diagram), the actuator can be used as a continuous 0...10 V, 2-point (OPEN/CLOSE) or 3-point actuator (OPEN/STOP/CLOSE) with an intermediate position. The running time of the actuator can be set with switches S1 and S2 according to requirements.

The manual adjustment is performed by releasing the gear unit using the adjuster beside the connection cable and simultaneously adjusting the spindle adaptor.

☑ Additional technical data

1 7712 25:

The upper section of the housing with the cover and indicator knob contains the synchronous motor with capacitor. The lower section of the housing contains the maintenance-free gear unit and the gear-release knob. To reverse the direction of rotation for 3-point control, the brown and black cables must be swapped. The actuators are protected against incorrect connection.

1 7712 27:

The upper section of the housing with the cover, indicator knob and cover knob contains the stepping motor and the SUT electronics. The lower section of the housing contains the maintenance-free gear unit, the gear-release lever and the spindle adaptor.

Connection diagram 1 7712 25

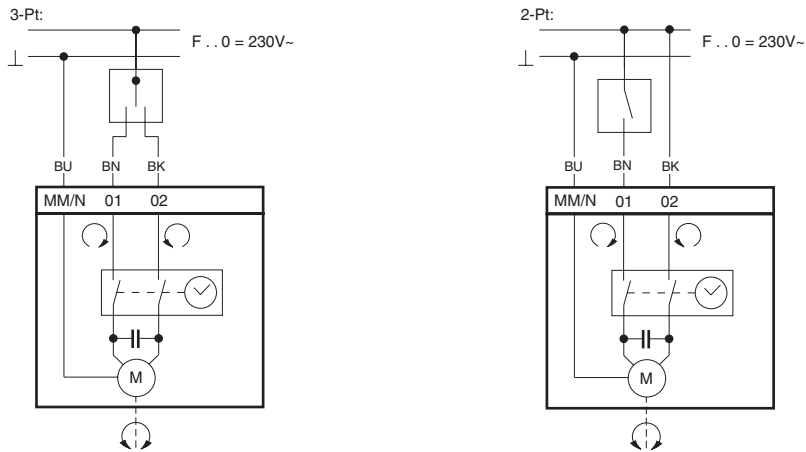

Connection diagram 1 7712 27

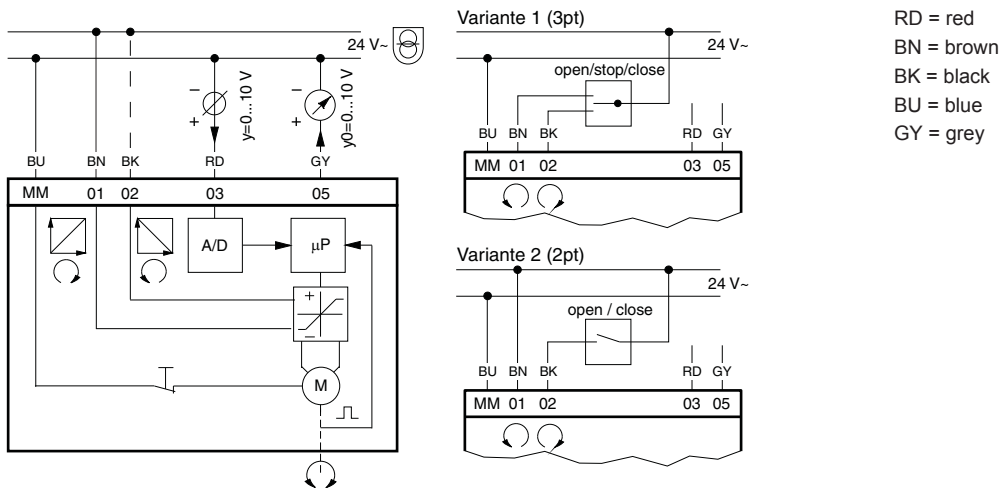

Connection as 2-point control unit

This OPEN/CLOSE activation can be performed via 2 cables. The actuator is connected to the voltage via the blue and brown cables. The damper actuator is moved to the end position by connecting the voltage to the black cable (clockwise direction to 100% angle of rotation). After the voltage is switched off, the actuator moves to the opposite end position. The unused red and grey wires must not be connected or come into contact with other cables. We recommend that you insulate these.

Connection as 3-point control unit

When voltage is applied to the cable (brown or black), the damper actuator can be moved to any desired position. Direction of rotation (viewing the spindle adaptor from the actuator):

- The spindle adaptor turns in the clockwise direction, with the voltage on the black cable.
- The spindle adaptor turns in the anti-clockwise direction, with voltage on the brown cable.

In the end positions (limit stop of damper, limit stop due to angle-of-rotation limit, max. angle of rotation of 95° reached) or in the case of an overload, the electronic motor cut-off is activated (no limit switches). Direction of rotation changed by transposing the connections.

The unused red and grey wires must not be connected or come into contact with other cables. We recommend that you insulate these.

Connection for control voltage 0...10 V

The built-in positioner controls the actuator depending on controller's output signal y.

Direction of rotation (viewing the spindle adaptor from the actuator):

Direction of operation 1 (mains power supply on brown cable):

When the positioning signal is increasing, the spindle adaptor turns in the clockwise direction

Direction of operation 2 (mains power supply on black cable):

When the positioning signal is increasing, the spindle adaptor turns in the anti-clockwise direction The starting point and the control span are fixed. Depending on the direction of operation, only the brown cable or the black cable may be connected. The other cable must be insulated.

When the voltage is connected, the stepping motor moves to the two end stops one after the other, and determines its effective angle of rotation. Thanks to the electronics, no steps can be lost, and the actuator does not require periodic re-adjustment. In the case of a power failure longer than at least 5 min, or directly after manual adjustment, the actuator automatically readjusts itself. When the angle of rotation is changed, the manual adjuster must be used to trigger a new adjustment so that the actuator, the control voltage 0...10 V and the feedback signal adjust to the new angle of rotation. Switch S3 can be used to switch off the automatic initialisation. The positioning motor now works in the manual or controlled initialisation mode and must be manually moved to the end stops by the controller output signal, or it is automatically moved to the end stops by the control behaviour in the control loop. If it detects a new limit stop, this is saved and the feedback signal is adjusted accordingly. Then the current position is calculated and output. When control signal 0...10 V is interrupted and direction of operation 1 is connected, the damper is closed completely (0% position).

Coding switch 1 7712 27

1 7712 27	S1	S2	S3
120s	OFF	ON	-
120s	ON	ON	-
60s	ON	OFF	-
60s	OFF	OFF	-
Initialisation on	-	-	ON
Initialisation off	-	-	OFF
Factory setting position	ON	ON	ON

Engineering and fitting notes

The concept of the synchronous motor enables the electric parallel operation of multiple damper actuators. The actuator can be installed in any position (including a hanging position). It is plugged directly onto the damper spindle and clipped to the anti-torsion device. The self-centring spindle adapter protects the damper spindle. The damper actuator can be detached from the damper spindle very easily without removing the anti-torsion device.

The angle of rotation can be limited to between 0° and 90° and continuously adjusted between 5° and 80°. The limit is fixed using a set screw directly on the actuator and the limit stop on the self-centring spindle adapter. The spindle adapter is suitable for Ø 8...16 mm and □ 6.5...12.7 mm damper spindles.

HERZ Valve actuator

Datasheet 7712 30, 31, Issue 0622

☑ Dimensions in mm

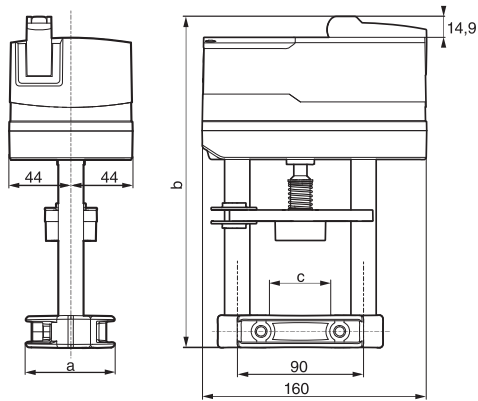

Model	a	b	c
1 7712 30	53	187,4	33
1 7712 31	64	241	44

☑ Models

1 7712 30 Valve actuator
 Actuating power 1000 N, Voltage AC 230 V, Control: 2-/3-point
 Actuating time: 6(12) s/mm; Stroke: 20 mm; Power consumption: < 2,4 W, < 4,0 VA

1 7712 31 Valve actuator
 Actuating power 1000 N, Voltage AC/DC 24 V, Control: 2-/3-point, constant
 Actuating time: 6(4) s/mm; Stroke: 20 mm; Power consumption: < 1,7 W, < 3,5 VA

☑ Features

- Crank handle for external manual adjustment with motor cut-off
- Low operating noise
- Simple assembly with valve; spindle is automatically connected after nominal voltage is applied
- Electrical parallel operation of five actuators
- Three-piece housing made of flame-retardant red/black plastic and seals with type of protection IP54
- Maintenance-free gear unit made of plastic, threaded spindle and gearbox base-plates made of steel
- Patented drive-valve coupling
- Mounting column of Aluminium
- Mounting bracket made of light metal casting for valve mounting with 20 mm stroke and made of plastic for valve mounting with 8 mm stroke
- Electrical connections (max. 1.5 mm²) with screw terminals
- Two break-out cable inlets for metric cable gland made of plastic M20 × 1.5

- Fitting position vertically upright to horizontal, not suspended
- Actuating power 1000 N (Actuating power 1000 N under nominal conditions (24 V or 230 V, 25 °C ambient temperature, 50 Hz). With boundary conditions (19.2 V~ / 28.8 V~ / 21.6 V= / 28.8 V=, -10°C / 55 °C, 60 Hz) and positioning time, the actuating/tensile force is minimised to 800 N)

Only 1 **7712 30**:

- For controllers with a switching output (2-point or 3-point control)
- Synchronous motor with electronic control unit and load-dependent cut-off
- Direction of operation and positioning time can be set using coding switches

Only 1 **7712 31**:

- For controllers with constant output (0...10 V / 4...20 mA) or switching output (2-point or 3-point control)
- BLDC motor (brushless DC) with SUT electronic control unit of the third generation and electronic load-dependent cut-off
- Automatic detection of applied control signal (continuous or switching), operating display with bi-colour LED
- Automatic adaptation to the stroke of the valve, between 8 and 20 mm
- With the built-in absolute distance measurement system, the position is always maintained in the case of power failure
- The direction of operation, characteristic (linear/equal percentage), positioning time and control signal (voltage/current) can be adjusted via coding switches
- Integrated forced operation can be set via coding switches (with selectable direction of operation)
- Easy re-initialisation using a coding switch
- Parameterisation option via the BUS interface

Technical data

Supply voltage 24 V~	±20%, 50...60 Hz
Supply voltage 24 V=	-10...20%
Supply voltage 230 V~	±15%
Actuating power	1000 N
Operating noise	< 30 dB (A) at maximum nominal force
Response time	> 200 ms
Temperature of medium	0...100 °C max.
Weight	1,6 kg
Operating temperature ambient	-10...55 °C
Storage and transport temp.	-40...80 °C
Humidity (no condensation)	5...85% rF
Type of protection	IP 54 (EN 60529)
Protection class	7712 30 : II u. III (IEC 60730) 7712 31 : III (EN 60730-1), EN 60730-2-14

CE conformity according to	EMV-Richtlinie 2014/30/EU EN 610000-6-1, EN 610000-6-2, EN 610000-6-3, EN 610000-6-4
Low-voltage directive	EN 60730-1, EN 60730-2-14 2014/35/EU
Over-voltage category	III
Degree of contamination	II
Max. altitude	2000 m
Machine directive	EN ISO 12100 2006/42/EG (according to appendix II, 1B)

1 7712 31:

Control signal y	0...10 V, $R_i \geq 50 \text{ k}\Omega$ 4...20 mA, $R_i \leq 50 \Omega$
Posit. feedback signal y0	0...10 V, load $\geq 5 \text{ k}\Omega$
Starting point U0	0 or 10 V
Starting point I0	4 or 20 mA
Control span ΔU	10 V
Control span ΔI	16 mA
Hysteresis Xsh	160 mV 0,22 mA

Description of operation

1 7712 30:

The actuator can be used as a 2-point (OPEN/CLOSE) or 3-point actuator (OPEN/STOP/CLOSE).

The running time of the actuator can be set with the S1 switches according to the respective requirements. Using switch S2, the direction of operation can be changed. In the end positions (valve limit stop or when the maximum stroke is reached) or upon overload, the electronic motor cut-off (no limit switch) responds and turns off the motor. The external crank handle enables manual positional setting. After the crank handle is folded back, the actuator can be started again normally. When the crank handle is folded out, the actuator remains in this position.

1 7712 31:

Depending on the type of connection (see connection diagram), the actuator can be used as a continuous (0...10 V or 4...20 mA), 2-point (OPEN/CLOSE) or a 3-point actuator (OPEN/STOP/CLOSE).

The positioning time of the actuator can be set with the S1 switches according to the respective requirements. Using switch S2, the direction of operation can be changed. In the end positions (valve limit stop or when the maximum stroke is reached) or upon overload, the electronic motor cut-off (no limit switch) responds and turns off the motor. The external crank handle enables manual positional setting. After the crank handle is folded back, the actuator moves to the target position again (without initialisation). When the crank handle is folded out, the actuator remains in this position.

Different types of connections

1 7712 30:

Connection as 2-point actuator (24 V or 230 V)

The OPEN/CLOSE activation is via two wires.

The actuator is connected to a permanent voltage via the terminals MM or N and terminal 01.

When voltage is applied to terminal 02, the actuator spindle retracts to the end position. After the voltage is switched off at terminal 02, the actuator spindle extends to the opposite end position.

Connection as 3-point actuator (24 V or 230 V)

If voltage is applied to the terminals MM or N and 01 (or 02), the valve can be moved to any desired position. If voltage is applied to terminal MM or N and 01, the actuator spindle extends. If the electrical circuit is closed via terminal MM or N and 02, the actuator spindle retracts. If there is no voltage on terminals 01 and 02, the actuator remains in the respective position until voltage is applied.

1 7712 31:

Connection as 2-point valve actuator (24 V)

The OPEN/CLOSE activation is via two wires. The actuator is connected to a permanent voltage via terminal MM and terminal 01. When voltage (24 V) is applied to terminal 02, the actuator spindle extends into the end position. After the voltage is switched off at terminal 02, the actuator automatically retracts into the base position. Terminal 03 may not be connected or touch other contacts. We recommend that you insulate these.

Connection as 3-point valve actuator (24 V)

If voltage is applied to terminals MM and 01 (or 02), the valve can be moved to any position. If voltage is applied to terminals MM and 01, the actuator spindle retracts. If the electrical circuit is closed on terminal MM and 02, the actuator spindle extends. If there is no voltage on terminals 01 and 02, the actuator remains in the respective position until voltage is applied. Terminal 03 may not be connected or touch other contacts. We recommend that you insulate these.

Connection to a control voltage (0...10 V or 4...20 mA)

The built-in positioner controls the actuator depending on controller's output signal y. A voltage signal (0...10 V) at terminal 03 serves as the control signal. Coding switch S4 can be used to switch to a current input (4...20 mA). If there is voltage on terminals MM/01 and a rising positioning signal, the actuator spindle extends. The direction of operation can be reversed with coding switch S2. The starting point and control span are fixed. After the connection of the power supply and the initialization, the actuator moves to every valve stroke between 0% and 100%, depending on the control signal. Thanks to the electronics and the absolute distance measurement system, no stroke is lost, and the actuator does not require periodic reinitialisation. If the control signal 0...10 V is interrupted in the direction of operation 1, the actuator spindle retracts completely. If the control signal 0...10 V is interrupted in the direction of operation 2, the actuator spindle extends completely. This is true if the forced operation is switched off. (Coding switch S5 OFF) With coding switch S3, the characteristic of the valve/actuator combination can be adjusted. An equal-percentage characteristic can only be generated when the actuator is used as a continuous actuator.

Initialisation and feedback signal

The actuator initialises itself automatically when it is connected as a continuous actuator (not in 2-/3- point mode).

When a voltage is applied to the actuator for the first time, the actuator first moves to the first and then to the second valve limit stop, or to the internal actuator stop. The two values are recorded and stored by the absolute distance measurement system. The control signal and the feedback are adapted to this effective stroke. After initialisation, the actuator goes to every valve stroke between 0% and 100%, depending on the control voltage.

In case of a power failure or the removal of the power supply, no re-initialisation needs to be carried out. The values remain saved. If the initialisation is interrupted, the initialisation is started again when the voltage is re-applied. You trigger a re-initialisation by switching coding switch S8 from OFF to ON or vice versa. When the process is triggered, the LED flashes green.

During initialisation, the feedback signal is inactive or equal to the value "0". The initialisation is carried out with the shortest positioning time. The re-initialisation is only valid when the whole process is complete.

If a stroke change is carried out, a re-initialisation must be triggered so that the new stroke can be adapted. If the valve actuator detects jamming, it reports this by setting the feedback signal to 0 V after approx. 90 s. During this time, the actuator continues to try to overcome the jamming. If the jamming can be overcome,

the normal control function is activated again and the feedback signal is restored. With 2-point or 3-point control without a feedback signal, no initialisation is performed.

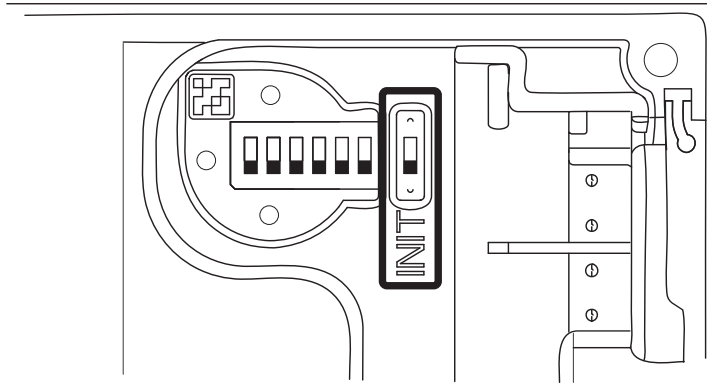

☑ **Connection diagram 1 7712 30**

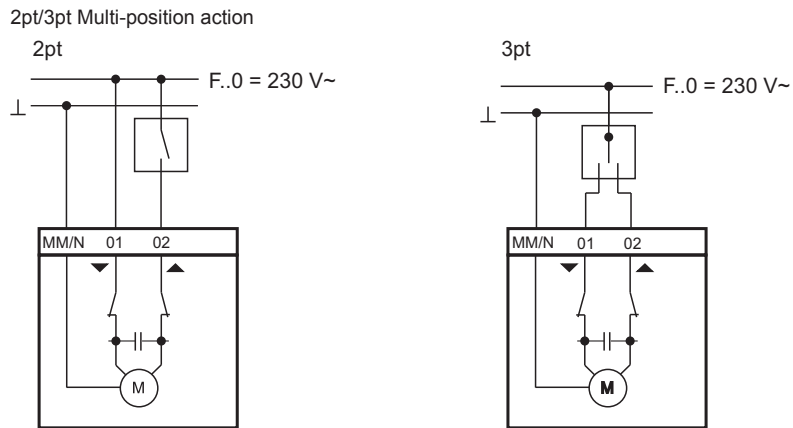

☑ **Connection diagram 1 7712 31**

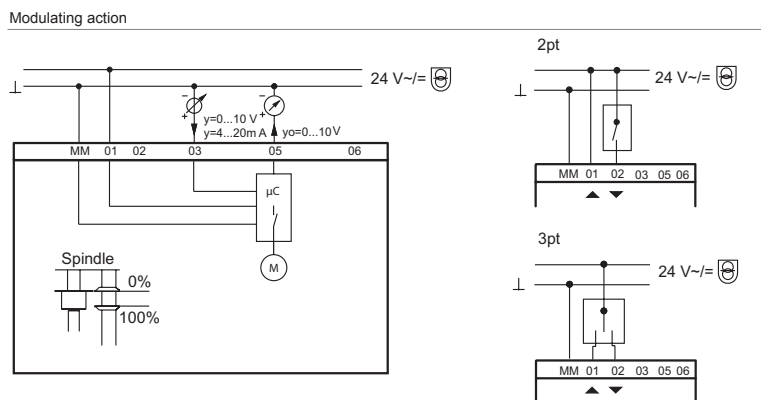

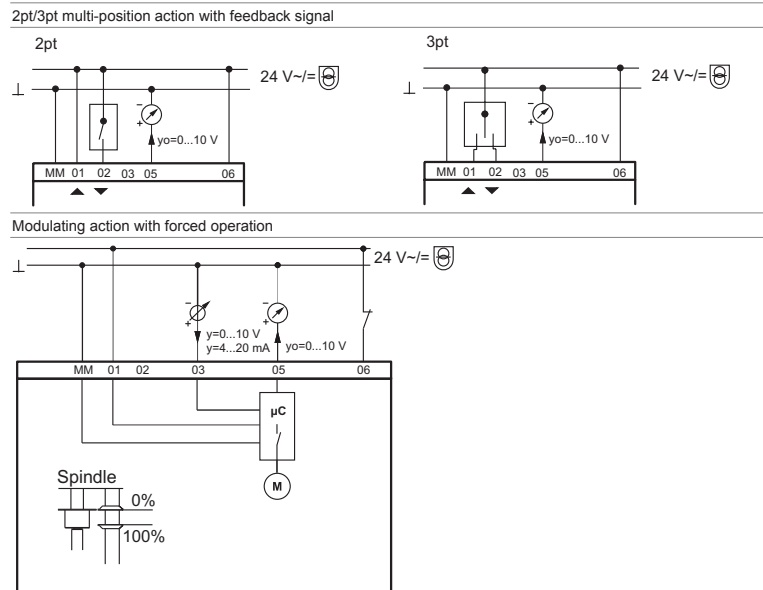

☑ Forced operation (in continuous mode 1 7712 31)

Forced operation is activated via coding switch S5. To use this function, an external on/off controller must be attached to terminal 6. The on/off controller functions as normally-closed contacts.

If the on/off controller opens the electrical circuit, the actuator spindle moves to the end position defined by coding switch S6. Forced operation can be used only in continuous mode.

☑ Engineering and fitting notes

The concept of a brushless DC motor/electronics ensures electrical parallel operation of up to five actuators of the same type. The valve is mounted directly on the actuator and fixed with screws (no further adjustments are required). The actuator is connected with the valve spindle automatically. As delivered ex works, the actuator spindle is in the middle position. Condensate, dripping water, etc. must be prevented from entering the actuator along the valve spindle.

The housing contains two break-out cable inlets for two metric plastic cable glands M20×1.5, which are broken out automatically when the cable inlet is screwed in. If the cable resistance is $> 1.5 \Omega$, the ground should be separated from the power supply and the signal if possible. The cross-section of the power cable must be selected based on the cable length and the number of actuators. With five parallel actuators and a cable length of 50 m, a cable cross-section of 1.5 mm² and a line resistance of $> 1.5 \Omega$ must be used (power consumption of the actuator $\times 5$). According to building installation regulations, the lines must be protected from overload or short circuit.

Note for UL and CSA applications:

In the United States, the installed lines and cross-sections which are to be connected by the customer must comply with the requirements of NFPA70 (NEC), and in Canada they must comply with the requirements of the standard C22.1-12 (CE Code).

Note:

The actuators are not suitable for use

- in potentially explosive environments,
- outdoor areas,
- on ships or vehicles,
- in plants or machinery where functional safety is required.

LED Indicator

LED	Description
Flashes green (T1s)	Valve adapting, initialisation
Flashes green (T3s)	Position reached
Lights up green	Actuating spindle moves IN/OUT
Flashes orange	Manual adjustment activated
Flashes red	Actuator jammed, actuator at end stop
Lights up red	Incorrect configuration of forced operation, undervoltage, insufficiently adapted stroke

 Accessory

Please, in order to choose a right adaptor to your valve, use the selection matrix.

1 7712 17 Adapter set for 1 7712 30 and 1 7712 31 for 2 and 3 way valves

HERZ Valve actuator

Datasheet 7712 28, 29, Issue 0622

☑ Dimensions in mm

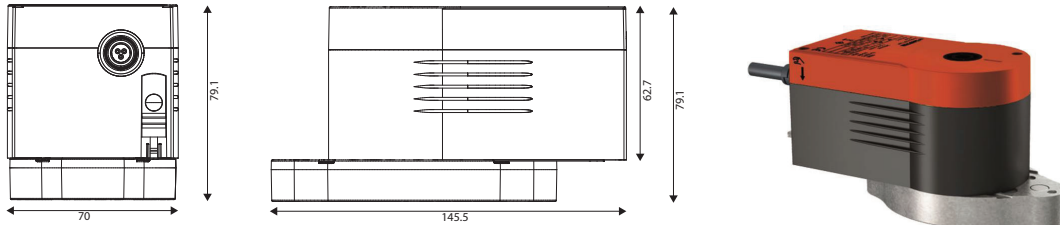

☑ Models

1 **7712 28** Valve actuator
 Actuating Power 500 N, Voltage AC 230 V, Control: 2-/3-point
 Running time: 7,5 s/mm, Power consumption: 3,2 W, 7 VA / 2 W, 5 VA

1 **7712 29** Valve actuator
 Actuating Power 500 N, Voltage AC/DC 24 V, Control: 2-/3-point, constant, Running time:
 7,5 s/mm / 15 s/mm, Power consumption: 3,5 W, 6,6 VA / 2,7 W, 5,3 VA

☑ Features

- For controllers with a switching (2-/3-point) output
- Synchronous motor with electronic control unit and cut-off and force-dependent cut-off, (1 **7712 29** only)
- Automatic recognition of applied control signal (continuous or switched) (1 **7712 29** only)
- Coding switches for selecting characteristic and running time (1 **7712 29** only)
- Type of characteristic (linear/equal-percentage) can be set on the actuator (1 **7712 29** only)
- Automatic adaptation to valve stroke (1 **7712 29** only)
- Direction of operation can be selected directly on the cable (1 **7712 29** only)
- Maintenance-free gear unit
- Gear unit can be disengaged in order to position the valve by hand with the provided hexagon key (load-free)
- Connection with valve spindle performed semi-automatically after control voltage is applied
- Fitting vertically upright to horizontal, not suspended

☑ Technical Data

Weight	1 kg
Housing	Lower section black, Upper section red

Housing material	Flame-retardant plastic
Power cable	1,2 m, 3×0,75 mm ² (1 7712 28) 1,2 m, 5×0,75 mm ² (1 7712 29)
Actuator stroke	8...20 mm
Response time	200 ms
Adm. ambient temperature	-10...55 °C
Adm. ambient humidity	5...85 % rF no condensation
Temperature of medium	Max. 100 °C
Type of protection	IP54 (EN 60529), horizontal
Protection class	1 7712 28: 230 V: II (EN 60730), 1 7712 29: III (IEC 60730)

1 7712 28:

Supply voltage	230 V~ ±15%, 50...60 Hz
Power consumption	2 W; 5 VA
Control	2-/3-point

CE conformity according to

EMV-directive 2014/30/EU	EN 61000-6-1, EN 61000-6-2 EN 61000-6-3, EN 61000-6-4
Low-Voltage Directive	EN 60730-1, EN 60730-2-14 2014/35/EU
Over-voltage category	III
Degree of contamination	II
Mach. directive 2006/42/EG	EN ISO 12100 (according to appendix IIB)

1 7712 29:

Power supply	
Supply voltage	24 V~ ±20%, 50...60 Hz
Supply voltage	24 V= -10%...20%
Power consumption	3,5 W, 6,6 VA; 2,7 W, 5,3 VA
Positioner	
Control signal y	0...10 V, R _i > 100 kΩ
Positional feedback signal	0...10 V, load > 10 kΩ
Starting point U ₀	0 V or 10 V
Control Span ΔU	10 V
Switching range X _{sh}	200 mV

CE conformity according to

EMC-directive 2014/30/EU	EN 61000-6-1, EN 61000-6-3, EN 61000-6-4
--------------------------	--

☑ Description of operation

1 7712 28:

When voltage is applied to the cable, the control unit to be activated is moved to any desired position by means of the coupling rod.

Direction of the stroke for 3-point control:

- The coupling rod moves out and the valve opens when the actuator is connected to the voltage via the blue (MM/N) and brown (01) cables.
- The coupling rod moves in and the valve closes when the actuator is connected to the voltage via the blue (MM/N) and black (02) cables.

With 3-point control, the direction of the stroke is changed by swapping the connections.

Direction of the stroke for 2-point control (there is always voltage on the black cable 02):

- The coupling rod moves out and the valve opens when the actuator is connected to the voltage via the blue (MM/N) and brown (01) cables.
- The coupling rod moves in and the valve closes when the actuator is connected to the voltage via the blue (MM/N) cable, and the brown (01) cable is not connected to the voltage. In the end positions (limit stop in valve or maximum stroke reached) or in the case of an overload, the magnetic coupling is activated. The electronic cut-out switches off the positioning signal after approx. 3 minutes.

The manual adjustment is performed in the load-free state by releasing the gear unit (slide switch beside the connection cable) and simultaneously turning it with the hexagon key on the top part of the actuator. 20 mm stroke is achieved with 4 turns. The actuator position can be determined by looking at the actuator bracket or the indicator knob on the top part of the actuator.

1 7712 29:

This valve actuator is used to control valves and may only be used for this purpose.

Depending on the type of connection (see connection diagram), the actuator can be used as a continuous 0...10 V, 2-point (OPEN/CLOSE) or 3-point actuator (OPEN/STOP/CLOSE) with an intermediate position. 2 running times are available for selection.

Switch S3 can be used to select the equal-percentage or linear characteristic. The 1 7712 29 is combined with valves that have an equal-percentage basic characteristic. The 1 7712 29 can be mounted on a valve with a linear characteristic, but the position of the coding switch must be considered.

The manual adjustment is performed in the load-free state by releasing the gear unit (slide switch beside the connection cable) and simultaneously turning it with the hex spanner on the top part of the actuator. 20 mm stroke is achieved with 4 turns.

Attention!

Damage to device!

► After the manual adjustment, the slide switch must be put back into its original position. (Engage gear unit)

☑ Description of operation

1 7712 28:

The upper section of the housing with the cover and indicator knob contains the synchronous motor with capacitor. The lower section of the housing contains the maintenance-free gear unit and the gear-release knob.

1 7712 29:

The upper section of the housing with the cover, indicator knob and cover knob contains the stepping motor and the SUT electronics. The lower section of the housing contains the maintenance-free gear unit.

☑ Connection diagram 1 7712 28

2pt/3pt Multi-position action

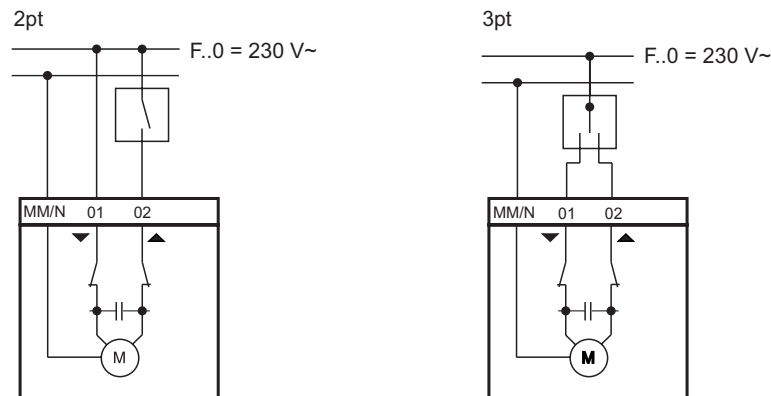

☑ Connection diagram 1 7712 29

Connection as 2-point actuator

This OPEN/CLOSE activation can be performed via 2 cables. The actuator is connected to the voltage via the blue and brown cables. The control passage of the valve is opened by connecting the voltage to the black cable. After this voltage is switched off, the actuator moves to the opposite end position and closes the valve.

The unused red and grey wires must not be connected or come into contact with other cables. We recommend that you insulate these.

Connection as 3-point control unit

When voltage is applied to the cable (brown or black), the valve is moved to any desired position. The coupling rod moves out and opens the valve when voltage is applied to the black cable. It moves in and closes the valve when the electrical circuit is closed via the blue and brown cables. In the end positions (limit stop in valve or maximum stroke reached) or in the case of an overload, the electronic motor cut-off is activated (no limit switches). Direction of the stroke changed by transposing the connections (BN/BK). The unused red and grey wires must not be connected or come into contact with other cables. We recommend that you insulate these.

Connection for control voltage 0...10 V

The built-in positioner controls the actuator depending on controller's output signal y.

Direction of operation 1 (mains power supply on brown cable):

When the positioning signal is increasing, the coupling rod moves out and opens the valve (control passage).

Direction of operation 2 (mains power supply on black cable):

When the positioning signal is increasing, the coupling rod moves in and closes the valve (control passage).

The starting point and control span are fixed.

After a manual adjustment or a power failure of more than at least 5 min, the actuator automatically readjusts itself.

After the power supply is connected, the stepping motor moves to the lower limit stop, makes the connection with the valve spindle, moves to the upper limit stop and thus defines the closing position.

After this, every stroke between 0 and 20 mm can be achieved, depending on the control voltage.

Thanks to the electronics, no steps can be lost, and the actuator does not require periodic re-adjustment. It is possible to operate multiple actuators of the same type in parallel. The feedback signal $y_0 = 0...10\text{ V}$ corresponds to the effective stroke.

When control signal $0...10\text{ V}$ is interrupted and direction of operation 1 is connected, the valve is closed completely (0% position).

The coding switch can be used to select the characteristic of the valve. Characteristics can only be generated when the actuator is used as a continuous actuator. The running times can be selected with additional switches. These can be used regardless of whether the 2-point, 3-point or continuous function is selected.

Software A EN60730	IP54 EN60529
---------------------------------	------------------------

BU	BN	BK	RD	GY
blau	braun	schwarz	rot	grau
bleu	brun	noir	rouge	gris
blue	brown	black	red	grey
azzurro	marrone	nero	rosso	grigio
azul	marrón	negro	rojo	gris
blå	brun	svart	röd	grå
blauw	bruin	zwart	rood	grijs

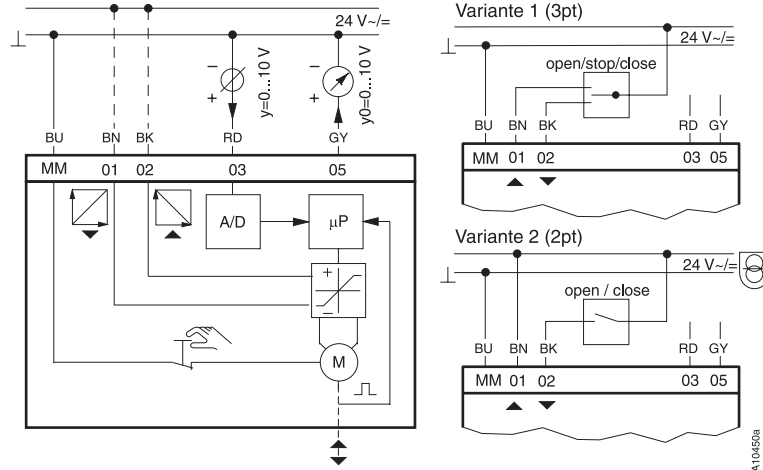

Laufzeit pro mm Temps de marche par mm Running time per mm	Schalterkodierung Codage de commutation Switch coding	Laufzeit für 8 mm Hub Temps de marche pour une course de 8 mm Running time for 8 mm of stroke	Laufzeit für 20mm Hub Temps de marche pour une course de 20mm Running time for 20mm of stroke									
7,5 s	<table border="1"> <tr><td>1</td><td>2</td><td>3</td></tr> <tr><td>■</td><td></td><td></td></tr> <tr><td>On</td><td></td><td>Off</td></tr> </table>	1	2	3	■			On		Off	60 s ± 2	150 s ± 5
1	2	3										
■												
On		Off										
15 s	<table border="1"> <tr><td>1</td><td>2</td><td>3</td></tr> <tr><td>■</td><td></td><td></td></tr> <tr><td>On</td><td></td><td>Off</td></tr> </table>	1	2	3	■			On		Off	120 s ± 4	300 s ± 10
1	2	3										
■												
On		Off										

☑ Connection diagram 1 7712 29

Condensate, dripping water, etc. must be prevented from entering the actuator along the valve spindle. Hanging position (fitting upside down) is not admissible.

The coupling of the valve spindle with the actuator spindle is performed semi-automatically using the manual adjuster.

When dismantling, first the actuator and valve spindles are released, then unscrewed. The concept of synchronous motor and magnetic coupling enables parallel operation of multiple valve actuators of the same type.

The auxiliary contacts accessory is screwed onto the side of the device.

Caution!

When the housing is opened there is a risk of injury through electric shock.

Opening the housing can damage the device.

► **Do not open the housing!**

Order number	DN	1771229 24 V mod., 2-3 Point 500 N, 20mm	1771231 24 V mod., 2-3 Point 1000 N, 20 mm	1771232 24 V mod., 2-3 Point 2500 N, 40 mm	1771221 24 V mod., 2-3 Point 2500 N, 40 mm	1771228 230 V 2, 3 Point. 500 N, 20mm	1771230 230 V 2, 3 Point. 1000 N, 20 mm	1771225 230 V 2, 3 Point.	1771227 24 V mod., 2-3 Point	1771233 230 V 2, 3 Point.	1771235 24 V mod., 2-3 Point
F 4006 71	15	1771220				1771220					
F 4006 90	15	1771220				1771220					
F 4006 72	15	1771220				1771220					
F 4006 91	15	1771220				1771220					
F 4006 73	25	1771220				1771220					
F 4006 92	25	1771220				1771220					
F 4006 93	25	1771220				1771220					
F 4006 53	25	1771220				1771220					
F 4006 74	32	1771220				1771220					
F 4006 94	32	1771220				1771220					
F 4006 75	40	1771220				1771220					
F 4006 95	40	1771220				1771220					
F 4006 61	40	1771220				1771220					
F 4006 80	40	1771220				1771220					
F 4006 96	50	1771220				1771220					
F 4006 62	50	1771220				1771220					
F 4006 81	65										
F 4006 97	65										
F 4006 63	65	1771220				1771220					
F 4006 82	80						1771218				
F 4006 98	80						1771218				
F 4006 64	80		1771217				1771217				

	1771229 24 V mod., 2-3 Point 500 N, 20mm	1771231 24 V mod., 2-3 Point 1000 N, 20 mm	1771232 24 V mod., 2-3 Point 2500 N, 40 mm	1771221 24 V mod., 2-3 Point 2500 N, 40 mm	1771228 230 V 2, 3 Point. 500 N, 20mm	1771230 230 V 2, 3 Point. 1000 N, 20 mm	1771225 230 V 2, 3 Point.	1771227 24 V mod., 2-3 Point	1771233 230 V 2, 3 Point.	1771235 24 V mod., 2-3 Point
F 4006 83	100									
F 4006 99										
F 4006 65		1771217				1771217				
F 4006 84	125									
F 4006 10										
F 4006 66										
F 4006 56	125									
F4006 67	150									
F4006 57	150									
F4006 68	200									
F4006 69	250									
F 4006 39	15				1771220					
F 4006 40	15				1771220					
F 4006 41	15				1771220					
F 4006 42	20				1771220					
F 4035 01	15				1771220					
F 4035 40					1771220					
F 4035 11	15				1771220					
F 4035 51					1771220					
F 4035 21	15				1771220					
F 4035 61					1771220					
F 4035 31	15				1771220					
F 4035 71					1771220					

	1771229 24 V mod., 2-3 Point 500 N, 20mm	1771231 24 V mod., 2-3 Point 1000 N, 20 mm	1771232 24 V mod., 2-3 Point 2500 N, 40 mm	1771221 24 V mod., 2-3 Point 2500 N, 40 mm	1771228 230 V 2, 3 Point. 500 N, 20mm	1771230 230 V 2, 3 Point. 1000 N, 20 mm	1771225 230 V 2, 3 Point.	1771227 24 V mod., 2-3 Point	1771233 230 V 2, 3 Point.	1771235 24 V mod., 2-3 Point
F 4035 03	25 1771220				1771220					
F 4035 43	1771220				1771220					
F 4035 13	25 1771220				1771220					
F 4035 53	1771220				1771220					
F 4035 04	32	1771217				1771217				
F 4035 44		1771217				1771217				
F 4035 05	40	1771217				1771217				
F 4035 45		1771217				1771217				
F 4035 16	50	1771217				1771217				
F 4035 56		1771217				1771217				
F 4035 07	65	1771217				1771217				
F 4035 47										
F 4035 08	80	1771217				1771217				
F 4035 48										
F 4035 09	100									
F 4035 49										
F 4035 10	125									
F 4035 50										
F 4035 41	150									
F 4035 52										
F 4037 01	15 1771220				1771220					
F 4037 11	15 1771220				1771220					
F 4037 21	15 1771220				1771220					

	1771229 24 V mod., 2-3 Point 500 N, 20mm	1771231 24 V mod., 2-3 Point 1000 N, 20 mm	1771232 24 V mod., 2-3 Point 2500 N, 40 mm	1771221 24 V mod., 2-3 Point 2500 N, 40 mm	1771228 230 V 2, 3 Point. 500 N, 20mm	1771230 230 V 2, 3 Point. 1000 N, 20 mm	1771225 230 V 2, 3 Point.	1771227 24 V mod., 2-3 Point	1771233 230 V 2, 3 Point.	1771235 24 V mod., 2-3 Point
F 4037 31	15 1771220				1771220					
F 4037 03	25 1771220				1771220					
F 4037 13	25 1771220				1771220					
F 4037 04	32	1771217				1771217				
F 4037 05	40	1771217				1771217				
F 4037 16	50	1771217				1771217				
F 4037 07	65	1771217				1771217				
F 4037 08	80	1771217				1771217				
F 4037 09	100									
F 4037 10	125									
F 4037 41	150									
1213701	15									
1213702	20									
1213703	25									
1213704	32									
1213705	40									
1213706	50									
1211711	15									
1211712	20									
1211713	25									
1211714	32									
1211715	40									
1211716	50									