

HERZ-TS-90-E

The thermostatic valve bodies with reduced resistance
 Universal models M 28 x 1,5
 Data sheet TS-90-E, Issue 0422

☑ Dimension in mm

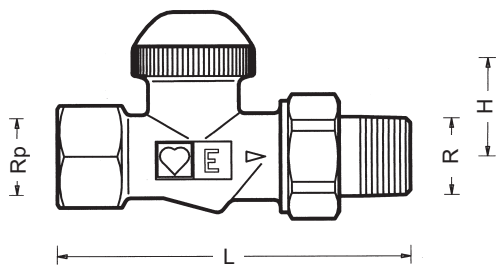

7723 E

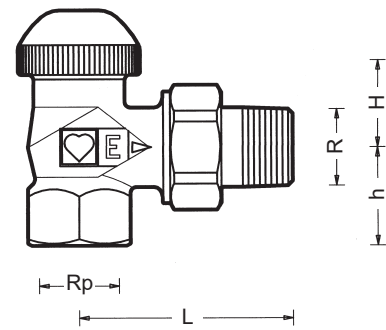

7724 E

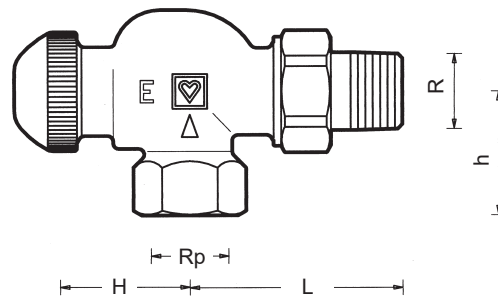

7728 E

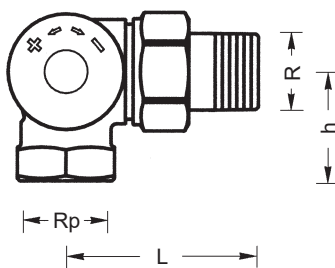

7758 E

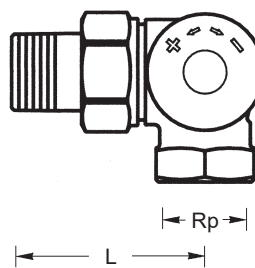

7759 E

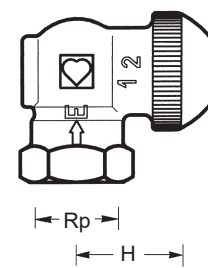

☑ Dimensions in mm

Art. No.	Designation	DN	Rp,"	R,"	Ø, mm	L, mm	H, mm	h, mm	Order No.
7723	Straight model	10	3/8	3/8	12	85	27	–	1 7723 00
		15	1/2	1/2	15	95	27	–	1 7723 01
7724	Angle model	10	3/8	3/8	12	52	27	22	1 7724 00
		15	1/2	1/2	15	58	23	26	1 7724 01
7728	Reverse angle model	10	3/8	3/8	12	49	35	27	1 7728 00
		15	1/2	1/2	15	55	35	33	1 7728 01
7758	3-axis valve „AB“	10	3/8	3/8	–	–	–	–	1 7758 01
		15	1/2	1/2	15	53	26	31	
7759	3-axis valve „CD“	10	3/8	3/8	–	–	–	–	1 7759 01
		15	1/2	1/2	15	53	26	31	

☑ Other models
HERZ-TS-E
Standard model with threaded socket
7723 E 1/2 – 1 Straight model

7724 E 1/2 – 1 Angle model

7728 E 1/2 – 1 Reverse angle model

For these versions, see the HERZ-TS-E data sheet.

☑ Operation data

Max. operating temperature 120 °C

Max. operating pressure 10 bar

Max. permissible differential pressure 0,2 bar

Water purity in accordance with the ÖNORM H 5195 and VDI 2035 standards.

☑ HERZ compression adapters

When using HERZ compression unions for copper and steel pipes, observe the permissible temperatures and pressures as specified in EN 1254-2: 1998 Table 5. The plastic pipe connections are suitable for application classes 4 and 5 according to ISO 10508 (panel heating and radiator connection) and for pipes made of PE-RT (EN ISO 22391), PP (EN ISO 15874), PB (EN ISO 15876) und PE-X (EN ISO 15875). This results in a maximum operating temperature of 95 °C at 10 bar. It is up to the user to select the operating pressure and temperature for the respective pipe type so that the standard values and the permissible operating data of the manufacturer are adhered to.

☑ Field of application

Water heating systems in one or two-pipe operation.

☑ Radiator connection

 Iron pipe connection **6210**, with cone seal.

 It is recommended that the HERZ assembly key **6680** be used.

☑ Further connecting options

Order numbers are available in HERZ Product Range Catalogue.

To be used instead of the radiator connection.

6210 1/2 Iron pipe connection, lengths 26 and 35 mm.

6211 3/8 Radiator connection, 1/2 x 3/8.

6218 3/8-3/4 Long threaded bush, without nut, can be shortened to even out installation dimension differences. Lengths 40, 76 and 70 mm.

6218 1/2 Threaded bush, without nut. Lengths 36, 39, 42, 48 and 76 mm.

6235 5/8-3/4 Solder connection, for pipe external diameters 12, 15 and 18 mm.

6249 3/8-3/4 Iron pipe connection elbow, without nut, conical seal.

6274 G 3/4 Compression adapter for chrome-plated metal pipes and stainless steel pipes, for external pipe diameters 8, 10, 12, 14, 15, 16 mm.

6098 G 3/4 Compression adapte for PE-X-, PB and plastic composite pipes.

To be used at the socket side of the valve:

6219 1/2 Reduction socket, brass version, for connecting pipe/valve, female thread (pipe) x male thread (valve), 1 x 1/2, 1¼ x 1/2, 1 x 3/4, 1¼ x 3/4.

6066 M 22 x 1,5 Plastic pipe connections for PE-X, PB and aluminium composite pipes, to be used with adapter 1 **6272** 01 (G 1/2 x M 22 x 1,5).

6098 G 3/4 Compression adapte for PE-X-, PB and plastic composite pipes, to be used with adapter 1 **6266** 01 (G 1/2 x G 3/4).

For pipe dimensions of plastic pipe connections please refer to Herz catalogue.

☑ Pipe connecting, universal models

The universal models are equipped with special sockets offering the option of connecting either a threaded pipe or calibrated soft-steel or copper pipe, the latter two by means of a compression union. The compression union must be ordered separately.

When using R = 1/2 valves for external pipe diameters of 10, 12, 14, 16 and 18 mm use adapter Art. No. **6272** between valve and the compression union.

Pipe Ø D mm		12	10	12	14	15	16	18
Valve	R=		1/2					
Adapter	Ord. No.	–	1 6272 01	1 6272 01	1 6272 01	–	1 6272 01	1 6272 11
Comp. union	Ord. No.	1 6292 00	1 6284 00	1 6284 01	1 6284 03	1 6292 01	1 6284 05	1 6289 01

We suggest using support sleeves for the installation of soft steel or copper pipes with compression union. For perfect compression union installation, it is imperative to lubricate the thread of the locking nut as well as the olive with oil. We refer to our instructions for installation.

☑ Special design features

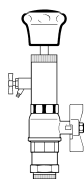

Changing the upper part of a thermostatic valve

The upper part of the HERZ thermostatic valve can be changed under pressure by means of the HERZ changing tool for the purpose of:

- Cleaning the seal at the spindle and/or changing the upper part of the valve. These are easy methods of removing defects in radiator thermostat valves, caused e. g. by foreign substances such as dirt, welding and soldering residues.

When using the valve with the new upper part follow the instructions enclosed with the changing tool.

☑ Spindle Seal

HERZ-TS-90 O-Ring-Chamber



An O-Ring is used as a spindle seal. It is located in a brass chamber which can be changing during operation. The O-Ring keeps maintenance requirements to a minimum and permits smooth valve operation over a long period of time.

Changing the O-Ring

1. Dismantle the HERZ thermostatic head and/or the HERZ-TS handwheel.
2. Then, the O-Ring chamber, including the O-Ring, is unscrewed and replaced with a new one. During this change, use a wrench to hold the upper part. During dismantling, the valve is completely open and therefore sealed tight. However, a few drops of water may leak out.
3. For re-assembly follow the above steps in reverse sequence. When installing the HERZ-TS handwheel, make sure that the valve closes by turning.

Article number for O-Ring set: 1 **6890** 00

☑ HERZ-Thermostatic valve

Nominal lift



The screw cap serves for operation during the installation phase (pipe flushing). The thermostatic valve is formed by removing the screw cap and screwing in the HERZ thermostatic head without draining the heating system.

Setting the nominal lift with the screw cap:

On the knurled part of the circumference of the screw cap there are two setting marks (webs in) alignment with the “+” and “-” marks.

1. Close the valve by turning the screw cap clockwise.
2. Mark the position corresponding to the setting mark „+“.
3. Turn the screw cap anti-clockwise until the setting mark “-” is at the position marked under item 2.

☑ Installation

The lower part of the thermostatic valve is incorporated into the radiator intake with the flow in the Installation direction of the arrow (arrow on the valve body). If possible, the HERZ thermostatic head should be in a horizontal position in order to permit optimum room temperature control and minimise interference.

☑ Important for installation

Under no circumstances should the HERZ thermostatic head be exposed to direct sunlight or to the Important for Installation effects of equipment emitting relevant quantities of heat, e.g. TV sets. If the radiator is covered by curtains this will lead to the formation of a heat accumulation zone in which the thermostat cannot sense the room temperature and consequently is not in a position to properly control it. In such cases, use the HERZ thermostat with remote sensor or the HERZ thermostat with remote adjustment.

For detailed information on the HERZ thermostats consult the individual standard sheets.

☑ Summer setting

After the end of the heating period open the valve completely by turning it in an anti-clockwise direction to prevent dirt deposits at the valve seat.

☑ HERZ-TS Handwheel

In the exceptional case that the HERZ thermostatic valve lower part is not equipped with a HERZ thermostatic head, the HERZ-TS handwheel is used to replace the screw cap. During installation, follow the instructions enclosed with the handwheel.

☑ Accessories

- 1 6680 00 HERZ Assembly key for connections
- 1 6807 90 HERZ-TS-90 Assembly key
- 1 7780 00 HERZ-Changefix tool, changing tool for thermostat upper parts

☑ Handwheel

- 1 9102 80 HERZ-TS-90-Handwheel, Serie 9000 „Design“

☑ Thermostatic head

- 1 7262 00 Radiator thermostat for maximum flow within the proportional range with automatic frost protection, limitation and locking of set value range, white hand wheel

☑ Spare parts

- 1 6379 02 HERZ-TS-90-E Upper thermostatic insert
- 1 6890 00 HERZ-TS-90 O-Ring set

☑ Disposal

Local and currently applicable legislation must be observed for disposal.

☑ Material

Pursuant to Article 33 of the REACH Regulation (EC No. 1907/2006), we are obliged to point out that the material lead is listed on the SVHC list and that all brass components manufactured in our products exceed 0.1 % (w / w) lead (CAS: 7439-92-1 / EINECS: 231-100-4). Since lead is a component part of an alloy, actual exposure is not possible and therefore no additional information on safe use is necessary.

HERZ-Standard diagram	HERZ-TS-90-E
-----------------------	--------------

Art. No. 1 7728 00	Dim. DN 10 R = 3/8
---------------------------	--------------------

Valve dimensioning [Δp] shall be performed in accordance with the "VDMA-Instruction Sheet for Planning and Hydraulic Balancing of Heating System with Thermostatic Radiator Valves". VDMA = Association of German Constructors.

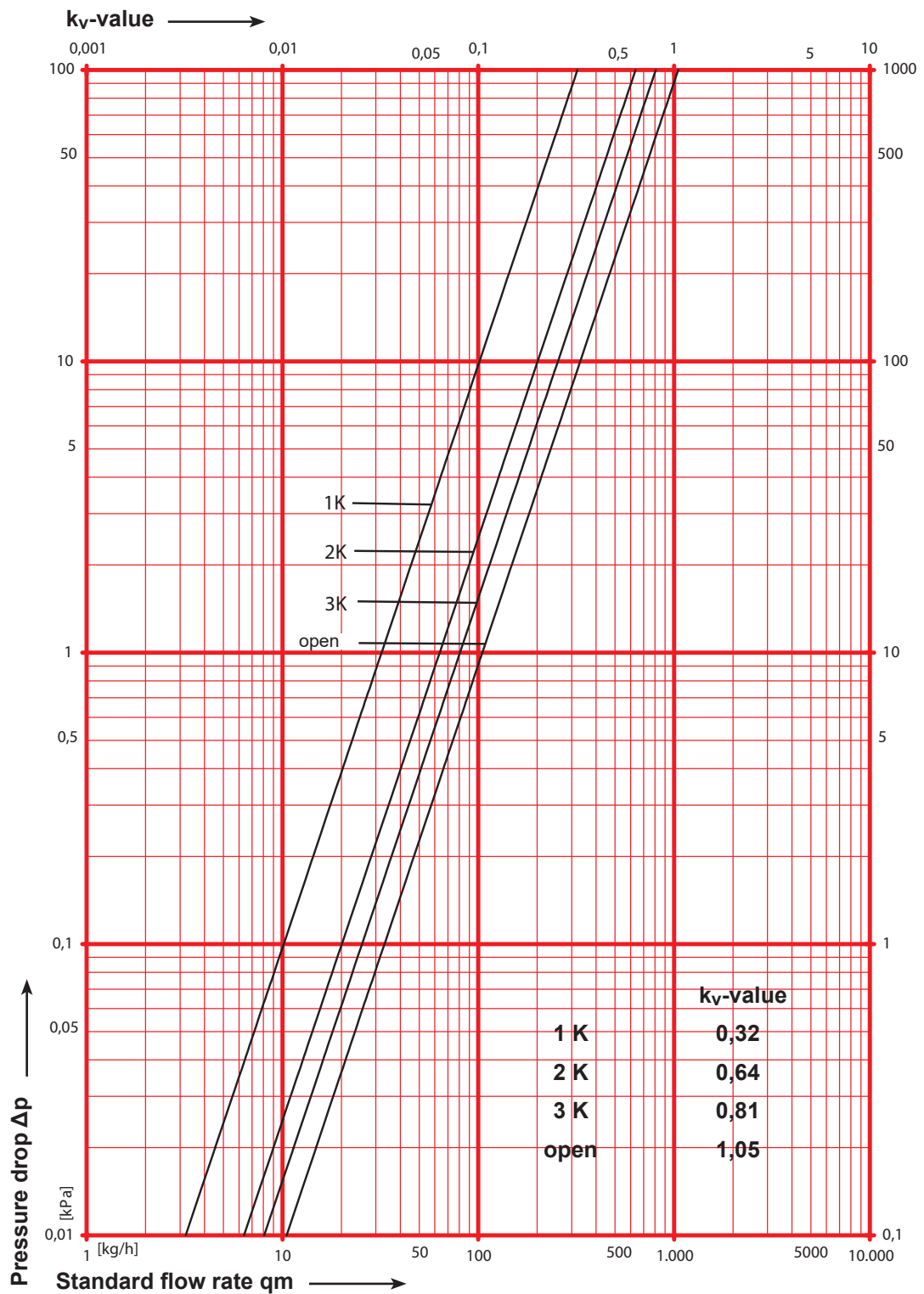

HERZ-Standard diagram	HERZ-TS-90-E
Art. No. 1 7724 00	Dim. DN 10 R = 3/8

Valve dimensioning [Δp] shall be performed in accordance with the "VDMA-Instruction Sheet for Planning and Hydraulic Balancing of Heating System with Thermostatic Radiator Valves". VDMA = Association of German Constructors.

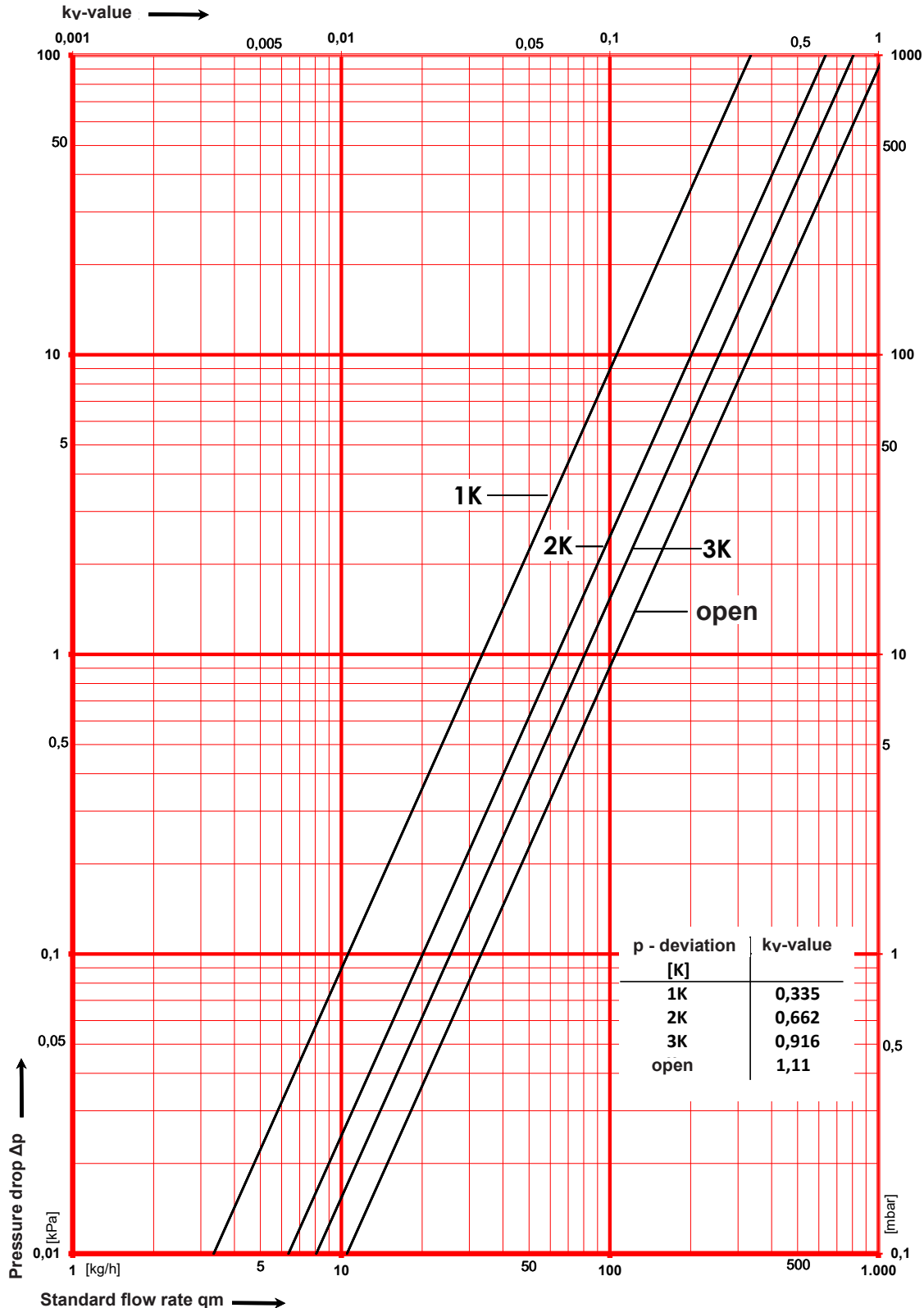

HERZ-Standard diagram	HERZ-TS-90-E
-----------------------	--------------

Art. No. 1 7724 01	Dim. DN 15 R = 1/2
--------------------	--------------------

Valve dimensioning [Δp] shall be performed in accordance with the "VDMA-Instruction Sheet for Planning and Hydraulic Balancing of Heating System with Thermostatic Radiator Valves". VDMA = Association of German Constructors.

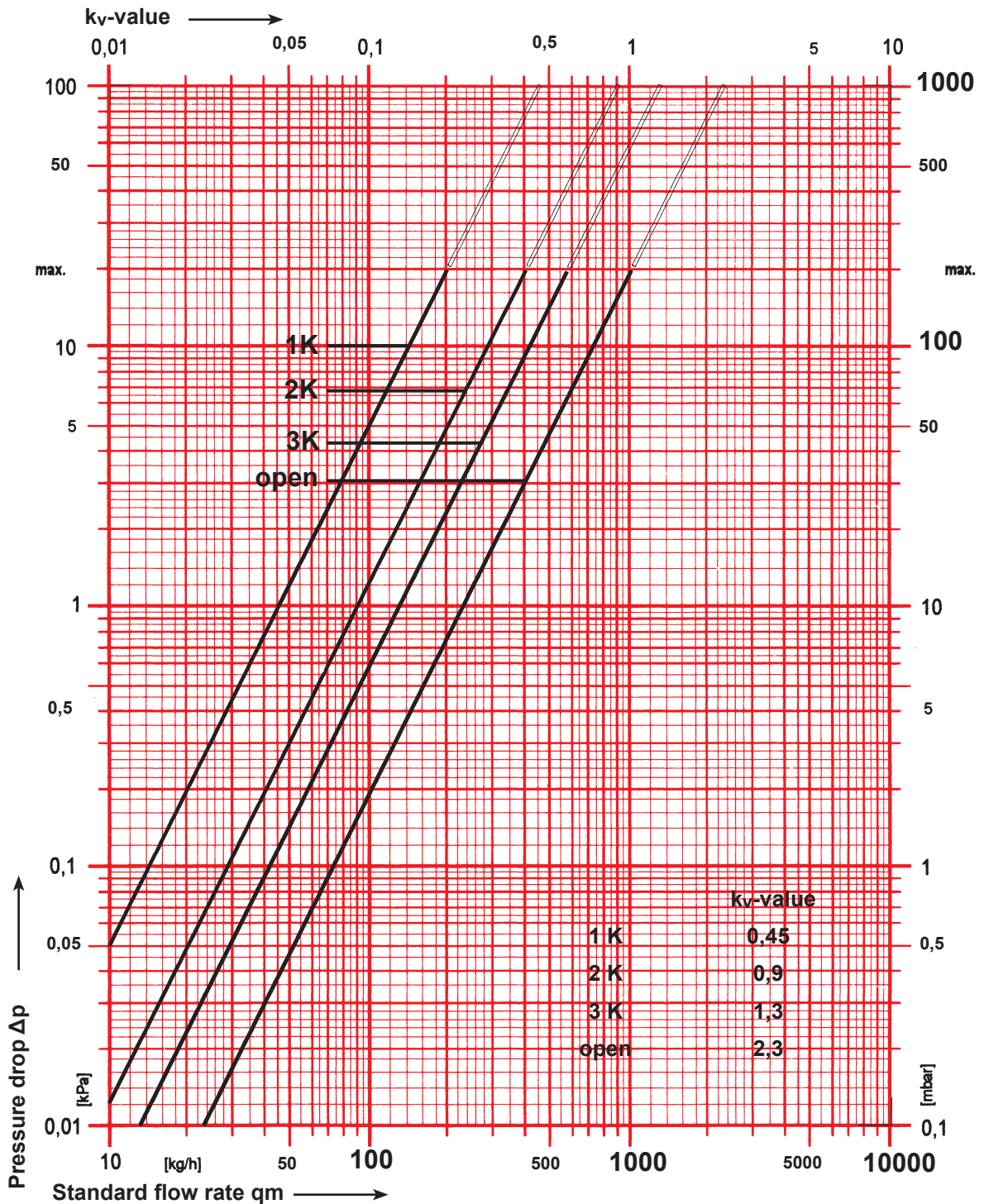

HERZ-Standard diagram	HERZ-TS-90-E
------------------------------	---------------------

Art. No. 1 7723 00	Dim. DN 10 R = 3/8
---------------------------	--------------------

Valve dimensioning [Δp] shall be performed in accordance with the "VDMA-Instruction Sheet for Planning and Hydraulic Balancing of Heating System with Thermostatic Radiator Valves". VDMA = Association of German Constructors.

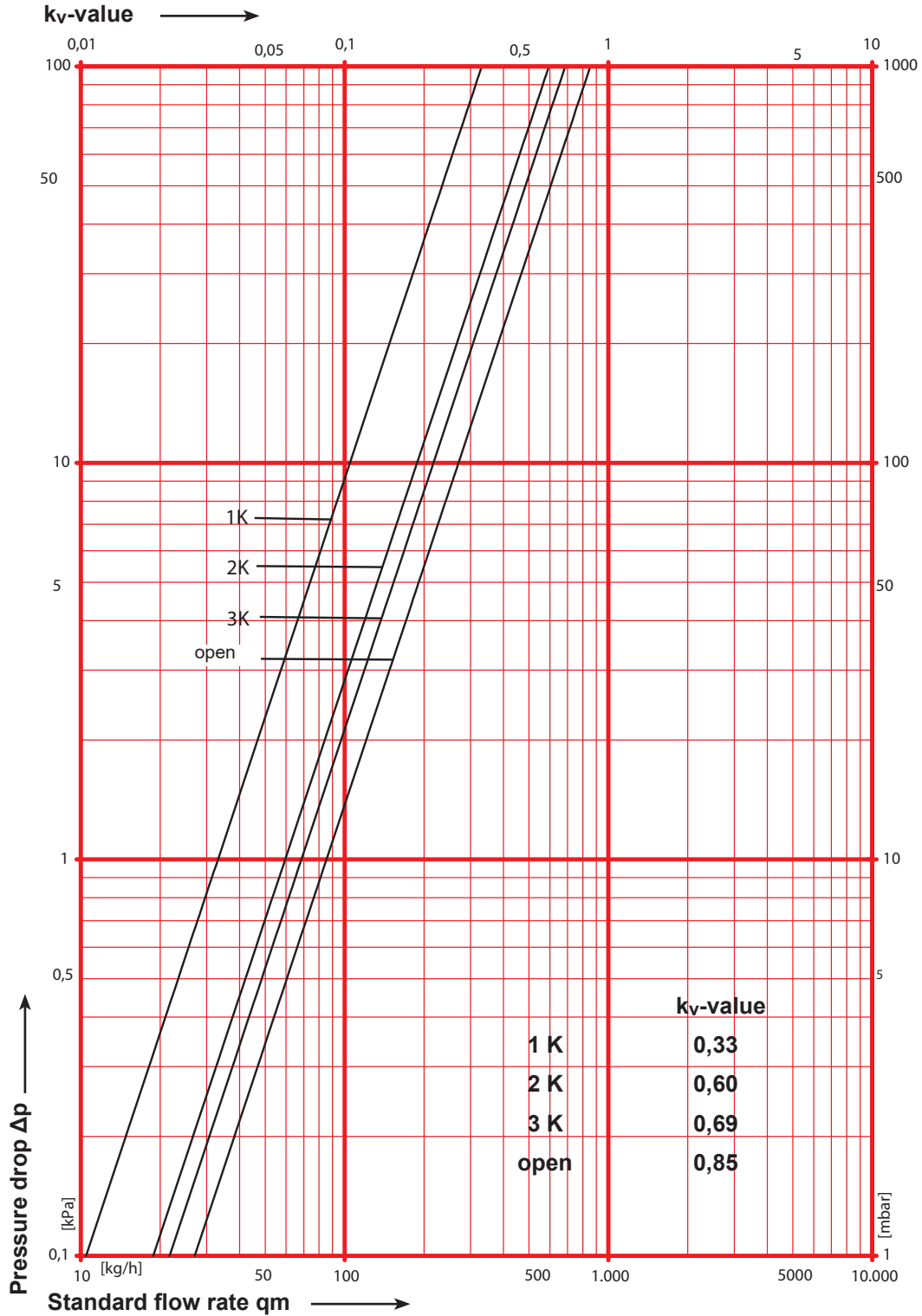

HERZ-Standard diagram	HERZ-TS-90-E
------------------------------	---------------------

Art. No. 1 7723 01, 1 7728 01, 1 7758 01, 1 7759 01	Dim. DN 15 R = 1/2
--	--------------------

Valve dimensioning [Δp] shall be performed in accordance with the "VDMA-Instruction Sheet for Planning and Hydraulic Balancing of Heating System with Thermostatic Radiator Valves". VDMA = Association of German Constructors.

