

HERZ-TS-98-V

TS-98-V thermostatic valves with continuous pre-setting and readout

Data sheet TS-98-V, Issue 0420

HERZ-TS-98-V
Thermostatic upper part

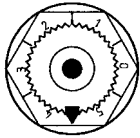

011
EN 215
checked and registered
Certified products
according to the
database DIN CERTCO

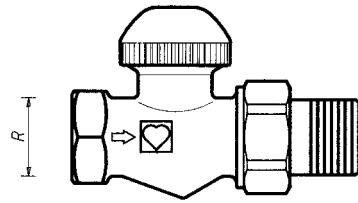

7623 V

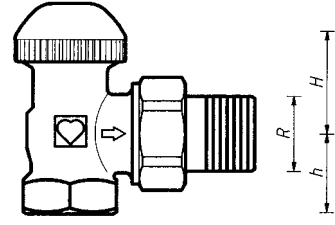

7624 V

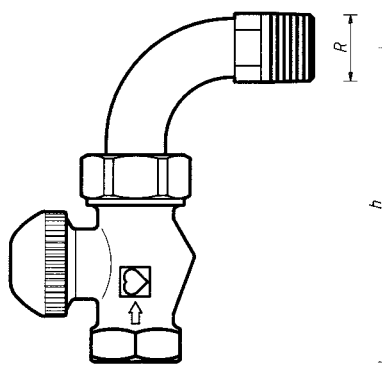

7623 V + 6249

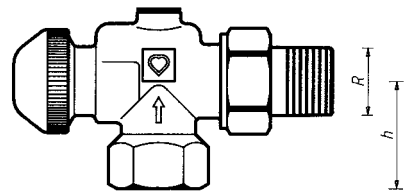

7628 V

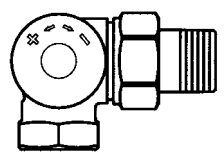

7658 V

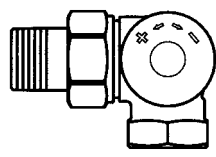

7659 V

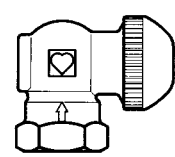

Special models

R = R 1/2
G = G 3/4

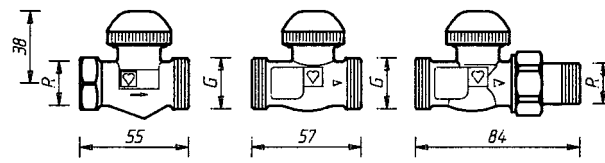

1 7623 71 1 7637 67 1 7633 67

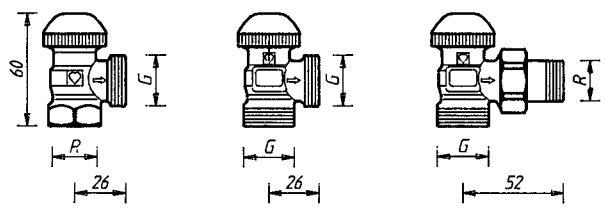

1 7624 71 1 7624 42 1 7638 67

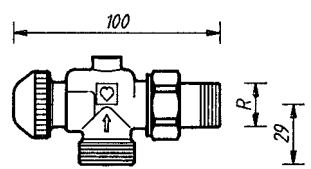

1 7648 67

☑ Dimensions in mm for Standard Series EN 215 T 2 HD 1215

Art. Nr.	Designation	DN	R	Ø	L	H	h	Order Nr.
7623 V	Dimensional Series "F" Straight valve	10	3/8	12	75	27	–	1 7623 65
		15	1/2	1	83	27	–	1 7623 67
		20	3/4	18	98	27	–	1 7623 69
7624 V	Dimensional Series "F" Angle valve	10	3/8	12	49	27	20	1 7624 65
		15	1/2	15	54	23	23	1 7624 67
		20	3/4	18	63	23	23	1 7624 69
7623 VD + 6249	EN 215 F Straight valve with elbow	10	3/8	12	40	27	84	Valve and elbow must be ordered separately
		15	1/2	15	54	27	94	
7628 V	Reverse angle model	10	3/8	12	49	35	27	1 7628 65
		15	1/2	15	55	35	29	1 7628 67
7658 V	AB	15	1/2	15	53	26	31	1 7658 67
7659 V	CD	15	1/2	15	53	26	31	1 7659 67
7623 VD	Dimensional Series „D“ Straight valve	10	3/8	12	85	27	–	1 7623 66
		15	1/2	15	95	27	–	1 7623 68
7624 VD	Dimensional Series „D“ Angle valve	10	3/8	12	52	27	22	1 7624 66
		15	1/2	15	58	23	26	1 7624 68
7623 VD + 6249	EN 215 D Straight valve with elbow	10	3/8	12	40	27	94	Valve and elbow must be ordered separately
		15	1/2	15	54	27	107	
		20	3/4	122	60	37	122	

☑ Models and versions

All models are nickel plated and supplied with an orange screw cap.
Universal models with special socket for threaded pipe connection and compression union:

HERZ-TS-98-V	7623 V	3/8-1/2	Straight valve, series F
	7624 V	3/8-1/2	Angle valve, series F
	7628 V	3/8-1/2	Reverse angle model
HERZ-3-D-V	7658 V	1/2	3-axis valve "AB", radiator to the right of the intake valve
	7659 V	1/2	3-axis valve "CD", radiator to the left

☑ HERZ-TS-98-V-valves in special versions

HERZ-TS-98-V-Ventile in Sonderbauformen, Dimension 1/2

1 **7633** 67 Straight model, radiator connection with cone seal, pipe connection male thread G 3/4

1 **7638** 67 Angle model, radiator connection with cone seal, pipe connection male thread G 3/4

1 **7648** 67 Angle model, special version, radiator connection with cone seal, pipe connection male thread G 3/4

☑ Other models

HERZ-TS-90 Valves without pre-setting function

HERZ-TS-90-E Valves with reduced resistance for one-pipe systems

HERZ-TS-E Valves with maximum flow for one-pipe systems

HERZ-TS-90-V Valves with continuous, concealed pre-setting

HERZ-TS-90-kv Valves with fixed kv-values for district heating systems

HERZ-TS-99-FV Thermostatic valves with ultra-fine 6 position pre-setting and readout

Separate standard sheets are available for these models.

☑ Operating data HERZ compression unions

Maximum operating temperature 110 °C

Maximum operating pressure 10 bar

When using HERZ compression unions for copper and steel pipes take into account the permissible temperature and pressure ratings according to EN 1254-2: 1998 specified in Table 5.

A maximum operating temperature of 80 °C and maximum operating pressure of 4 bar applies for plastic pipe connections, if permitted by the pipe manufacturer.

☑ Field of Application

Water heating systems in which hydraulic balancing via return valves is not possible or not desired.

☑ Radiator Connection

Iron pipe connection 6210, with cone seal, installed.

It is recommended that the HERZ assembly key 6680 is used.

☑ Further Connecting Options

Order numbers can be found in the HERZ Product Range

To be used instead of the radiator connection and on the male thread G 3/4:

6210 1/2 Iron pipe connection, lengths 26 or 35 mm

6211 1/2 Reducing connection, 1/2" x 3/8".

6213 3/8 Reducing connection, 3/8" x 1/2".

6218 3/8-1/2 Long threaded bush, without nut, can be shortened to compensate differences in structural dimensions, lengths 3/8" x 40; 1/2" x 39, 42 and 76 mm.

6218 1/2 Threaded bush, without nut, lengths 36, 48 and 76 mm.

6235 3/8-1/2 Soldering connection, 3 x 8" x 12; 1/2" x 12, 15 and 18 mm.

6249 3/8-1/2 Iron pipe connection elbow, without nut, with cone seal

6274 G 3/4 Compression union for copper and thin-walled steel pipes, for external pipe diameters 8,10,12,14,15,16 and 18 mm.

6276 G 3/4 Compression union with soft seal for copper and thin-walled steel pipes, particularly suitable for hard special steel pipes and pipes with hard galvanised surfaces. For external pipe diameters 12, 14, 15, 16 and 18 mm.

6098 G 3/4 Compression union for PE-X-, PB and plastic composite pipes.

To be used at the socket side of the valve:

6219 1/2 Reduction socket, brass version, for pipe-valve connection, female thread (pipe) x male thread (valve), 1" x 1/2", 1 1/4" x 1/2".

6066 M 22 x 1,5 Plastic pipe connection for PE-X-, PB and plastic composite pipes, to be used with adapter 1 **6272** 01 (R 1/2 x M 22 x 1.5).

6098 G 3/4 Plastic pipe connection for PE-X-, PB and plastic composite pipes, to be used with adapter 1 **6266** 01 (R 1/2 x G 3/4).

For pipe dimensions of plastic pipe connections please refer to Herz catalogue.

☑ Pipe Connection Universal models

The universal models are equipped with special sockets offering the option of connecting either a threaded pipe or a calibrated soft-steel or copper pipe, the latter two by means of a compression union. The compression union must be ordered separately.

When using R = 1/2" valves for external pipe diameters of 10, 12, 14, 16, and 18 mm, use adapter Art. No. 6272 between valve and compression union.

Pipe Ø D mm		12	10	12	14	15	16	18
Valve R =		3/8	1/2					
Adapter Order No.		–	1 6272 01	1 6272 01	1 6272 01	–	1 6272 01	1 6272 11
Compression Union Order No.		1 6292 00	1 6284 00	1 6284 01	1 6284 03	1 6292 01	1 6284 05	1 6289 01

We suggest using support sleeves for the installation of soft steel or copper pipes with compression union. For perfect compression union installation, it is imperative to lubricate the thread of the locking nut as well as the olive with oil. We refer to our instructions for installation.

☑ Presetting Function

Presetting is performed by means of a flow restrictor downstream of the valve seat enclosing the seat. This flow restrictor is continuously adjustable from outside. It does not obstruct the working lift of the valve spindle.

Presetting can be performed manually by means of the orange presetting button, by setting the pointer on the presetting button to the figure on the scale of the upper part obtained by calculation or from the HERZ standard diagram.

For convenient presetting, the HERZ-TS-98 setting key (1 6819 98) is available, which engages with the teeth of the presetting button.

☑ Compatible with HERZ-TS-90 Changing the Upper Part of a Thermostatic Valve

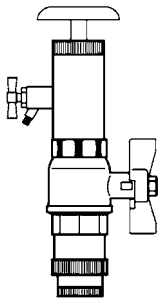

HERZ-TS-90 valves are available in four series with different upper parts.

- HERZ-TS-90 – standard version
- HERZ-TS-90-kv – thermostatic valves with fixed kv-values
- HERZ-TS-90-V – thermostatic valves with continuous presetting
- HERZ-TS-98-V – thermostatic valves with continuous presetting and readout.

If it turns out, while the heating system is in operation that another upper part is to be preferred for individual control of volume flows through the radiator, the HERZ Changefix Tool makes replacing of the upper part easy, even while the heating system is on.

The seat seal can be cleaned in the same way. This is an easy way of removing defects in radiator thermostatic valves, caused, e.g., by foreign substances such as dirt, welding or soldering residues. When working with the HERZ Changefix Tool follow the instructions enclosed with this device.

☑ Setting Process HERZ-TS-98-V Setting Key 1 6819 98

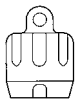

1. Remove HERZ thermostatic head, handwheel or screw cap.
2. Directly set the orange setting button (set between 4 and 5 by the manufacturer) to the desired presetting step 1–6 (0) either manually or by means of the setting key (1 6819 98).
3. Install HERZ thermostatic head or handwheel.

The value set is thus secured.

☑ Spindle Seal HERZ-TS-98-V-Valve Upper Part



The spindle seal is a special sealing ring which keeps maintenance requirements at a minimum and ensures ease of valve operation over a long period of time. If the spindle seal is worn, the valve upper part is replaced which means simultaneous replacement of the seat seal which may also be damaged. The presetting step is to be re-set after changing the upper part.

1. Remove the HERZ thermostatic head or the HERZ-TS handwheel.
2. Unscrew and remove the old upper part and replace it with a new one.
3. Replace HERZ thermostatic head or HERZ-TS handwheel.

The upper part can be changed by means of the HERZ changing tool while the heating system is under pressure. Follow the instructions for the HERZ changing tool.

Order Number for HERZ-TS-98-V Valve upper part: 1 6367 98

☑ HERZ-Thermostatic Valve Nominal Lift



The screw cap is used for operation during the installation phase (pipe flushing). The thermostatic valve is automated by removing the screw cap and screwing in the HERZ thermostatic head without draining the heating system.

Adjustment of nominal lift by means of screw cap:

On the knurled part of the circumference of the screw cap there are two setting marks (webs) in alignment with the “+” and “-” marks.

1. Close the valve by turning the screw cap clockwise
2. Mark the position corresponding to the setting mark “+”
3. Turn the screw cap anticlockwise until the setting mark “-” is at the position marked according to item 2.

☑ HERZ-TS Handwheel



In the exceptional case that the HERZ thermostatic valve lower part is not equipped with a HERZ thermostatic head, the HERZ-TS handwheel is used to replace the screw cap.

During installation, follow the instructions enclosed with the handwheel.

☑ Installation

The lower part of the thermostatic valve is incorporated into the radiator intake with the flow in the Installation direction of the arrow (arrow on the valve body). If possible, the HERZ thermostatic head should be in a horizontal position in order to permit optimum room temperature control and minimise interference.

☑ Important for Installation

Under no circumstances should the HERZ thermostatic head be exposed to direct sunlight or to the Important for Installation effects of equipment emitting relevant quantities of heat, e.g. TV sets. If the radiator is covered by curtains this will lead to the formation of a heat accumulation zone in which the thermostat cannot sense the room temperature and consequently is not in a position to properly control it. In such cases, use the HERZ thermostat with remote sensor or the HERZ thermostat with remote adjustment.

For detailed information on the HERZ thermostats consult the individual standard sheets.

☑ Summer Setting

After the end of the heating period open the valve completely by turning it in an anti-clockwise direction to prevent dirt deposits at the valve seat.

☑ Accessoires Handwheels

- 1 6680 00 Assembly key for radiator connections
- 1 6819 98 HERZ-TS-98-V Setting key
- 1 7780 00 HERZ-Changefix tool, changing tool for thermostat upper parts
- 1 9102 80 HERZ-TS-90-Hand wheel, Series 9000 “Design“

☑ Spare Parts

- 1 6367 98 Upper thermostatic insert with pre-setting for HERZ-TS-98-V

☑ Disposal

Local and currently applicable legislation must be observed for disposal.

☑ Material

Pursuant to Article 33 of the REACH Regulation (EC No. 1907/2006), we are obliged to point out that the material lead is listed on the SVHC list and that all brass components manufactured in our products exceed 0.1 % (w / w) lead (CAS: 7439-92-1 / EINECS: 231-100-4). Since lead is a component part of an alloy, actual exposure is not possible and therefore no additional information on safe use is necessary.

All specifications and statements within this document are according to information available at the time of printing and meant for informational purpose only. Herz Armaturen reserves the right to modify and change products as well as its technical specifications and/or its functioning according to technological progress and requirements. It is understood that all images of Herz products are symbolic representations and therefore may visually differ from the actual product. Colours may differ due to printing technology used. In case of any further questions don't hesitate to contact your closest HERZ Branch-office.

HERZ-Standard diagram	HERZ-TS-98-V
-----------------------	--------------

7623 V - 7723 V	Dim. DN 10 R = 3/8 • DN 15 R = 1/2
-----------------	------------------------------------

Valve dimensioning (Δp) must be performed in accordance with the "VDMA-Instruction Sheet for Planning and Hydraulic Balancing of Heating Systems with Thermostatic Radiator Valves."

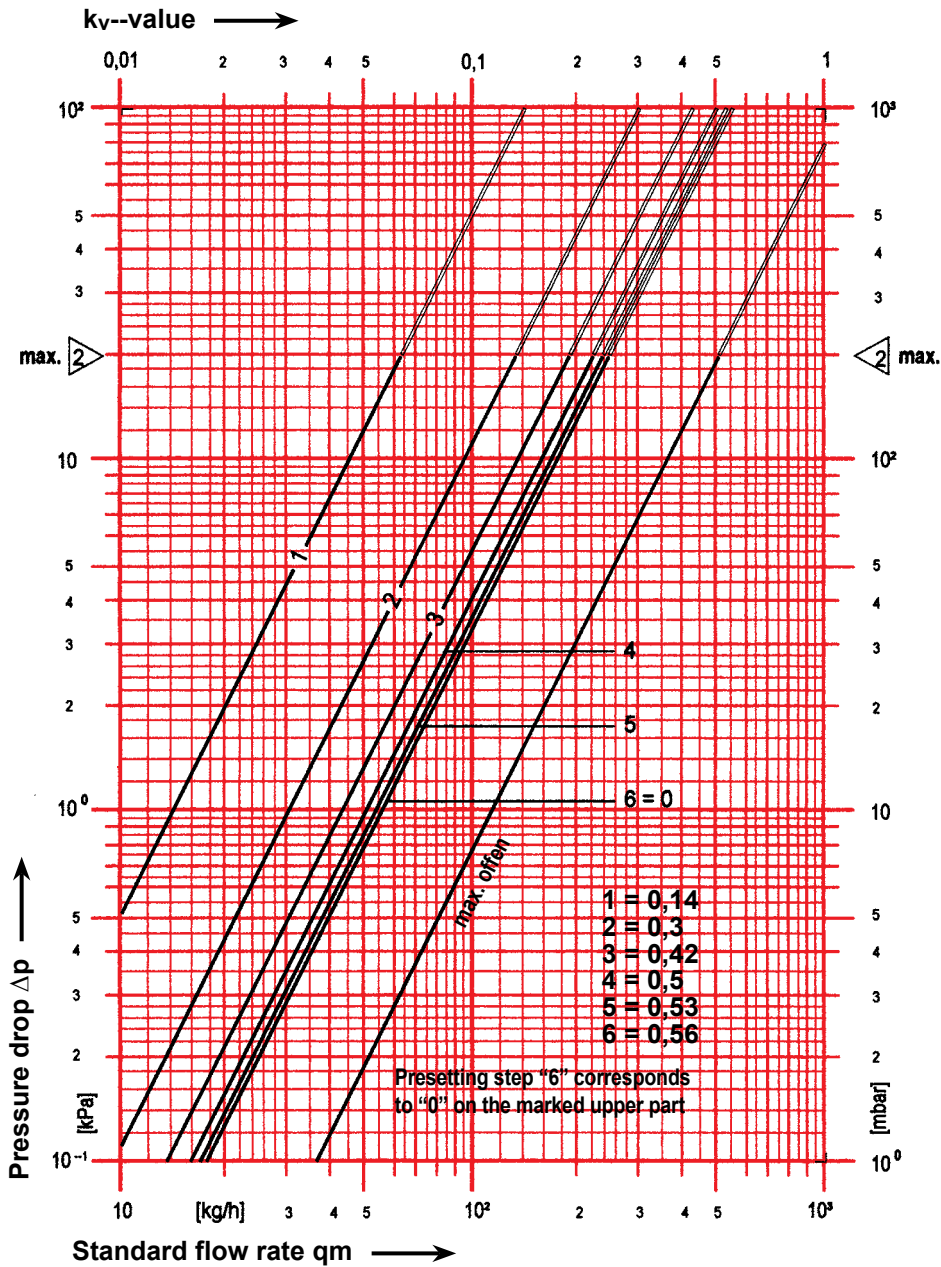

The information refers to a static pressure of 2,5-10 bar

p - deviation [K]	kv-value							
	0,5	1	1,5	2	2,5	3	3,5	4
Presetting								
1	0,05	0,11	0,14	0,14	0,14	0,14	0,14	0,14
2	0,13	0,25	0,29	0,30	0,30	0,30	0,30	0,30
3	0,14	0,26	0,38	0,42	0,44	0,44	0,45	0,45
4	0,14	0,27	0,39	0,50	0,54	0,55	0,56	0,57
5	0,15	0,28	0,40	0,53	0,66	0,70	0,72	0,73
6	0,15	0,28	0,41	0,56	0,70	0,76	0,80	0,81