

HERZ Thermostatic head with liquid sensor

Data sheet for 7230/7260, Issue 1022

HERZ Thermostatic head



011
EN 215
checked and registered
Certified products:
1 7230 06
1 7260 06

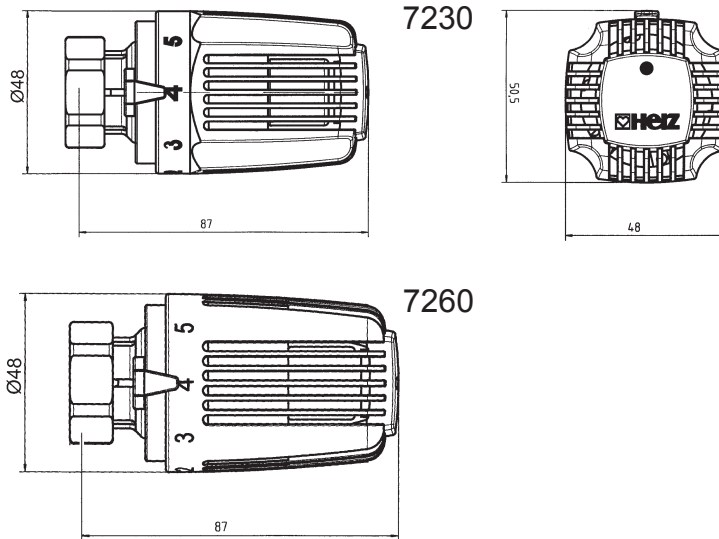

Models

- 1 7230 06 **Radiator thermostat with liquid sensor (hydrosensor)**
with position „0“, adjustable frost protection, limitation and locking of set value range. White hand wheel.
- 1 7260 06 **Radiator thermostat with liquid sensor (hydrosensor)**
with automatic frost protection and limitation and locking of set value range. White hand wheel.

Operational data

set point range	7230:	8-28 °C
	7260:	8-28 °C
frost protection		~ 8 °C

Manufacturer specifications

Order number	Hysteresis at nominal flow	Differential pressure influence	Closing time in min	Water (heating medium)-temperature influence	CA-value
1 7230 06	0,8	0,5	15	0,9	0,6
1 7260 06	0,8	0,5	15	0,6	0,6

Application

Can be combined with any HERZ valve suitable for thermostatic operation.
Further information on article numbers, dimensions and delivery type can be found in the appropriate data sheets.
The HERZ thermostat is maintenance-free.

Operation

The HERZ thermostat serves as probe and control element. The valve spindle is moved when the volume of the liquid filling of the HERZ hydrosensor changes.

Logo clip



On request, we can deliver the logo clip including your company's logo.

☑ Setting options 7230/7260

By adjusting the scale marking to the indicator the following approximate temperatures can be reached in the room, allowing temperature (K) deviations according to the installation and system type.

Marking	*	1	2	3	4	5	6
°C	~ 8	~ 9,5	~ 13	~ 16,5	~ 20	~ 23,5	~ 28

☑ Comfort setting „4“

The "4" comfort setting corresponds to a room temperature of approximately 20°C and offers optimum comfort and energy saving.

☑ Frost protection

Set to „*“ position the valve opens at an ambient temperature of approximately 8°C and prevents the system from freezing.

☑ Shutoff thermostat 7230

Set to position „0“, the thermostatic valve is shut off and the frost protection is overridden.

☑ Summer setting

When the heating period ends, open the thermostat by turning anti-clockwise. This prevents dirt adhering on the valve seat.

☑ Theft protection

For theft protection, snap clips 1 9552 03 can be ordered, which can be fastened over the union nut.

☑ Accessories

1 6640 00	HERZ universal key to open theft protection
1 6807 90	HERZ-TS-90 assembly key
1 9551 00	Stop pins for limitation and locking of the set value range
1 9552 03	Theft protection (snap clips), open with key 1 6640 00
1 7000 00	Logo clip, unmarked

☑ Installation

1. Unscrew the screw cap or hand wheel from the valve.
2. Set the thermostatic head to the "fully open" position (preset) and place it on the lower part of the valve until the lower part locks and the indicator is completely visible.
3. Do up the union nut and tighten gently (key SW 30).
4. Check functionality by turning the handwheel (e.g. handwheel is set to setting 4 - comfort setting)

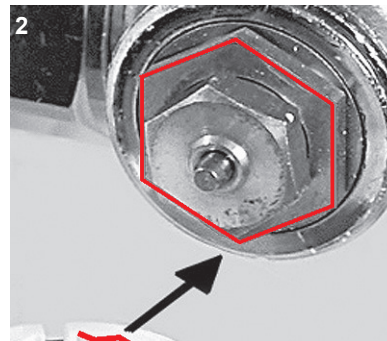

☑ Assembly instructions

The HERZ thermostatic head should not be subjected to direct sunlight or heat radiating devices (e.g. TV). If the radiator is covered by panelling or heavy curtains, heat will accumulate and the thermostat is therefore unable to sense and adjust the room temperature. In this case use the HERZ thermostat with remote sensor or remote setting.

9430 HERZ thermostat with remote adjustment

9330 HERZ thermostat with remote sensor and "0" position

UNI HERZ thermostat with remote sensor and automatic frost protection

The appropriate standard sheets provide further technical information about these three products.

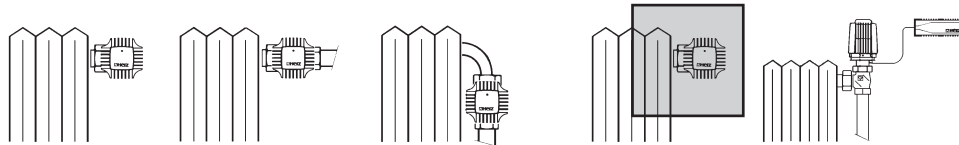

Hidden limitation or locking

To prevent unauthorized limitation or locking of the turning range, install one or two plug-in type stop pins.

The stop pins can be ordered as accessories, article number 1 9551 00 - 1 set.

☑ Procedure

The lower part of the thermostatic head has a base part with circular holes to house the stop pins.

- Set the thermostatic head to the required limiting, or locking position.
- Between the hand wheel scale positions "6" and „“ is a line that shows the marking for setting the stop pins. It is advisable to follow the same procedure as for "limitation."
- Set hand wheel to required set value (picture 1)
- Upward limitation
Place pin in alignment to the left-hand end of the line (picture 2)
- Downward limitation
Place pin in alignment to the right end of the line (picture 3)
- Locking
Place a pin at the left and right ends of the line (picture 4)
- Plug in the stop pins until the stop (thick end). They can be removed with an appropriate tool (pliers etc).



Picture 1



Picture 2



Picture 3



Picture 4

☑ Disposal

The disposal of HERZ thermostatic head must not endanger the health or the environment. Local and currently valid legislation must be observed for disposal.

☑ Brass

Pursuant to Article 33 of the REACH Regulation (EC No. 1907/2006), we are obliged to point out that the material lead is listed on the SVHC list and that all brass components manufactured in our products exceed 0.1% (w / w) lead (CAS: 7439-92-1 / EINECS: 231-100-4). Since lead is a component part of an alloy, actual exposure is not possible and therefore no additional information on safe use is necessary.

Please note: All specifications and information within this document are reflecting the information available at the time of going to print and meant for informational purpose only. Herz Armaturen reserves the right to modify and change products as well as its technical specifications and/or its function according to technological progress and requirements. All diagrams are indicative in nature and do not to be complete. It is understood that all images of Herz products are symbolic representations and therefore may visually differ from the actual product. Colours may differ due to printing technology used. In case of any further questions don't hesitate to contact your closest HERZ Branch-Office.