

HERZ-Thermostat

HERZCULES – Thermostatic Head, Robust Version

Data Sheet for **9860, 9861, 9860 H, 9861 H**, Edition 0618



 011
 EN 215
 tested and registered
 certificated products:
 1 9860 10
 1 9860 98

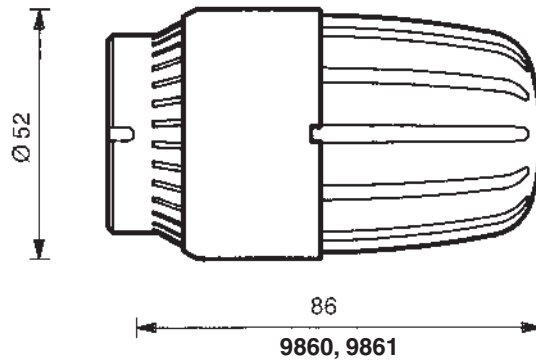

☑ Models, application

HERZCULES, radiator thermostat in robust version

Protection against vandalism, theft and unauthorised operation.

Mounting, dismounting and set point control only possible with special tools. Locked and concealed set point. With automatic frost release.

1 **9860** 10 HERZCULES, thermostatic head for mounting on HERZ-Valves, suitable for thermostatic operation.

1 **9860** 98 HERZCULES, thermostatic head "H", for direct mounting on radiators with integrated valves and thermostatic valves with threaded connection M 30 x 1.5.

1 **9861** 10 Thermostatic head same as model 1 **9860** 10, temperature can be decreased by 10k, adjustable

1 **9861** 40 Thermostatic head same as model 1 **9860** 10, temperature can be decreased by 4k, adjustable

1 **9861** 98 Thermostatic head same as model 1 **9860** 98, temperature can be decreased by 10k, adjustable

1 **9861** 48 Thermostatic head same as model 1 **9860** 98, temperature can be decreased by 4k, adjustable

HERZCULES 9861 for rooms in which the set and hidden set value temperature may be temporarily or permanently decreased but not increased.

☑ Operational data

Temperature can be decreased, adjustable 9861

Set value range 8–26 °C

The HERZ-thermostat is maintenance-free.

The set value temperature is set using special tools, same as for model **9860**.

Using a coin, the set value can be adjusted up to a maximum of –4k or –10k

The temperature can therefore be decreased while ventilating the room or when the room is not in use without changing the standard setting of the device.

Warning: Decrease in temperature is only possible if the desired room temperature (set value temperature) has been set correctly. Please note, that the maximum decrease in temperature (up to –10 K) is outside the range that could cause damage to the heating system or building (e.g. from frost or mildew).

☑ Product Information

Order number	Hysteresis at Nominal flow	Differential pressure influence	Closing time	Water temperature influence
1 9860 10	0,35 K	0,15 K	22 min	1,1 K
1 9860 98	0,35 K	0,15 K	22 min	1,1 K

☑ Mode of operation

The HERZ-thermostat serves as a sensor and control element. The change in volume of the liquid contained in the HERZ-hydrosensor actuates the valve spindle.

☑ Setting options

Handwheel scale

By setting the scale marks above the pointer it is possible to achieve approximately the following temperatures in the room. Deviations of a few degrees of temperature (K) are possible according to the mode of installation and the design of the heating system.

Setting	min	T	=	•	≡	max
approx. °C	8	12	16	20	24	26

☑ Position „•“

Position „•“ corresponds to a room temperature of approx. 20 °C. This means optimum comfort and energy saving..

☑ Summer setting

After the end of the heating period, open thermostat completely by setting to the max. position (using unlocking tool 1 9554 00) in order to prevent the formation of dirt deposits at the valve seat.

☑ Important for installation

The HERZ-thermostatic head should not be subjected to direct sunlight or heat radiating devices (e.g. TV). The thermostatic heads can only sense and adjust correctly if the air ways to the integrated sensor are clear and not affected by anything covering the thermostatic head or the whole radiator e.g. if the radiator is covered by panelling or heavy curtains, heat will accumulate and the thermostat is therefore unable to sense and adjust to the room temperature.

☑ HERZ-Thermostatic Valves

For article numbers, dimensions, and form of delivery of HERZ-valves refer to the Data Sheets for HERZ-Thermostatic Valves the respective products.

Accessories

1 6616 00	Allen Key SW 2
1 9554 00	Unlocking tool
1 9554 01	Tightening tool
1 6362 20	Thermostatic adapter ring “D” for mounting on radiators with integrated valves with Danfoss thermostatic inserts M 20 x 1
1 6362 23	Thermostatic adapter ring “D” for mounting on radiators with integrated valves with Danfoss thermostatic inserts M 23.5 x 1.5

Components

The thermostatic head features the following components visible from outside which are mentioned in this Data Sheet:

- ① **Fastening nut**
metallic, nickel-plated, with 2 securing screws (2-mm-Allen screws).
- ② **Rib ring,**
can be rotated around the fastening nut.
- ③ **Locking sleeve** with indentation.
- ④ **Hand wheel** with set value marks.

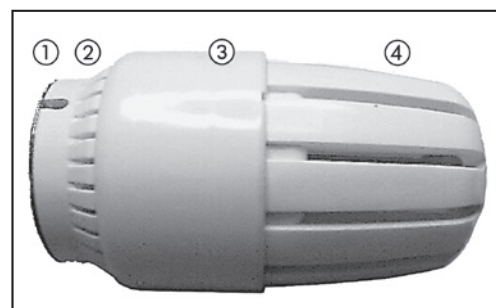

Installation

Remove screw cap from the valve.

Screw thermostatic head in completely open position (as delivered) onto the valve.

Twist the rib ring ② clockwise until the fastening screws become visible through the two screw slots directed towards the valve.

Insert tightening tool in such a way that the two pins engage in the two screws and tighten slightly by turning clockwise.

Use a 2-mm-Allen key to tighten the two screws which can be seen through the slots of the rib ring ②. In this way, the thermostatic head is secured to the valve. The rib ring ② can be turned as required to cover the securing screws.

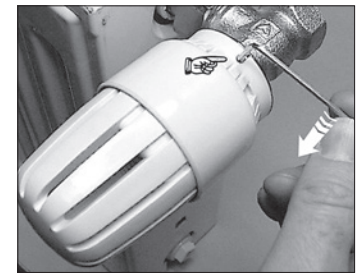
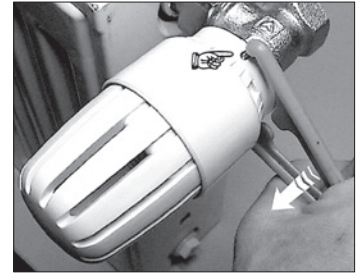

Tools

Unlocking tool 1 9554 00



Tightening tool 1 9554 01

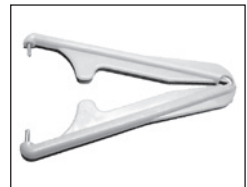

2-mm-Allen Key 1 6616 00



Set value adjustment

Turn the handwheel which can be turned in either direction together with the locking sleeve ③ until the indentation on the hand wheel side of the locking sleeve can be seen in the area of the printed marks.

Unlocking

Place unlocking tool into position by laying it over the rib ring in such a way that the wedges point towards the thermostatic head and the projecting mark is located above a screw slot of the rib ring ②.



Introduce the unlocking tool up to the stop into the slot between rib ring ② and locking sleeve ③.



The locking sleeve ③ is unlocked and can be slid towards the locking nut. When this is done, the setting marks of the handwheel become visible. The unlocking tool can be removed.

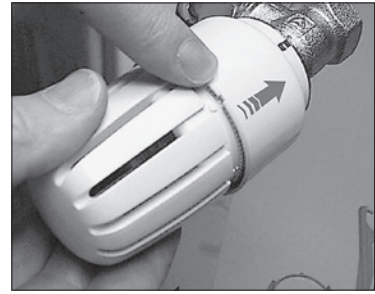

Setting and Locking

While holding the locking sleeve, turn the handwheel until the desired setting mark aligns with the indentation of the locking sleeve.



Then, without tools, slide the locking sleeve towards the handwheel until the hand wheel scale is covered and the sleeve clicks into position.



Operation

The temperature setting is now secured and cannot be changed without tools. The handwheel can be turned in either direction without changing the set value.

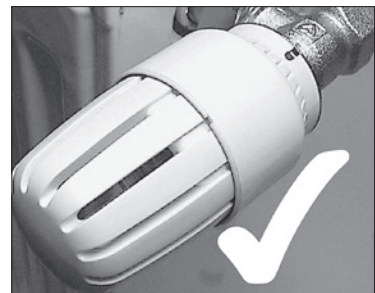

Adjustable temperature decrease

The thermostatic head is equipped with an adjustable dial with blue markings. Each section of the blue markings corresponds to a setting interval of minus 1K – the thicker the marking, the greater the decrease in temperature. The indicator is the raised display on the hand-wheel.



The device is preset at zero (0 K) decrease in temperature. Turning the adjustable dial clockwise (towards the right) decreases the temperature.

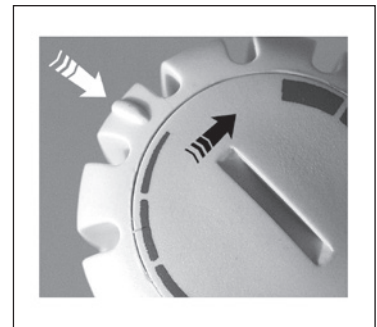

Using a coin and starting from the preset condition (zero decrease), the desired decrease can be set.

Attention! Each extreme of the blue markings (–0 K, –4 K/–10 K) is equipped with a stop. Trying to adjust the adjustable dial with too much force may damage the thermostatic head which means that correct performance can no longer be guaranteed.



Example: To set a decrease in temperature of –3K, start at the preset point and turn the device clockwise up to the third blue marking interval.

To achieve a greater decrease, continue to turn clockwise. To decrease, turn anti-clockwise until the preset condition (zero decrease) is reached.

